

High Current Fuses



MEGA® 70V HP Fuse-SF51

MEGA® High Performance Fuse Rated 70V-SF51

The MEGA® 70V-SF51 High Performance (HP) Fuse is designed for high current circuit protection up to 500A with "Diffusion Pill Technology." The MEGA 70V HP features 1MΩ Open State Resistance after fuse opening to guarantee safe interruption at any voltage up to 70V. The MEGA® 70V HP Fuse is ideal for battery and alternator protection application and other heavy gauge cables requiring ultra-high current protection.

Specifications

Voltage Rating:	70 VDC
Interrupting Rating:	2500A @ 70 VDC
Recommended Environmental Temperature:	-40°C to + 125°C
Terminals Material:	Tin Plated Copper
Housing Material:	PPA-GF33 (U.L. 94 Flammability rating – HB)
Mounting Torque M6:	9Nm+/-1Nm
Mounting Torque M8:	20Nm+/-1Nm
Open State Resistance (after fuse opening)	>1MΩhm
Complies With:	ISO 20934 - Type SF51



Time-Current Characteristic Curves

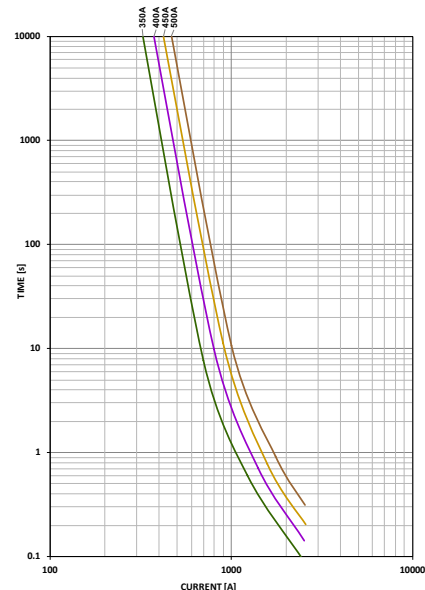
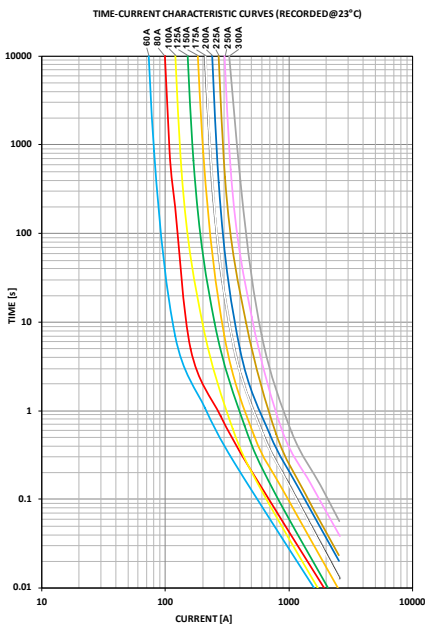

Ordering Information

Part Number	Rating	Package Size	Bolt Size	Bolt Hole Qty
0998xxx.UX-2M8	60 - 500	500	M8	2
0998xxx.UX-1M8	60 - 500	500	M8	1
0998xxx.UX-2M6	60 - 500	500	M6	2
0998xxx.UX-1M6	60 - 500	500	M6	1
0998xxx.UX-NH	60 - 500	500	N/A	0

Time-Current Characteristics

% of Rating	Opening Time Min / Max (s)		
	60-250A	300A	350-500A
75	-/-	14,400 / ∞	14,400 s / ∞
100	14,400 / ∞	-/-	-/-
135	120 / 1800	120 / 1800	-/-
150	20 / 450	20 / 450	-/-
200	1 / 15	1 / 15	1 / 15
350	0.3 / 5	0.3 / 5	0.5 / 5
600	0.1 / 1	0.1 / 1	0.1 / 1

Ratings

Part Number	Current Rating (A)	Font Color	Test Cable Size (mm ²)	Typ. Voltage Drop (mV)	Typ. Cold Resistance (mΩ)	Typ. I ² t (A ² s)
0998060_	60		6	75.5	0.90	22,800
0998080_	80		10	88.0	0.75	34,900
0998100_	100		10	66.7	0.46	24,000
0998125_	125		16	70.4	0.37	38,000
0998150_	150		25	70.6	0.32	58,100
0998175_	175		25	79.2	0.28	79,300
0998200_	200		35	76.9	0.24	123,600
0998225_	225		35	76.6	0.21	142,500
0998250_	250		50	66.0	0.17	220,000
0998300_	300		50	46.9 ²	0.15	340,000
0998350_	350 ¹		50	50.7 ²	0.14	495,000
0998400_	400 ¹		70	50.1 ²	0.12	872,000
0998450_	450 ¹		70	52.9 ²	0.10	1,224,000
0998500_	500 ¹		70	56.3 ²	0.09	1,800,000

¹ Short Circuit Protector only

² Voltage Drop measurements for short circuit protectors taken at 75% of rated current.

The typical I²t is an average value calculated from the breaking capacity tests by using the melting time before the arcing occurs.

REV07272021

Littelfuse® products are not designed for, and shall not be used for, any purpose (including, without limitation, automotive, military, aerospace, medical, life-saving, life-sustaining or nuclear facility applications, devices intended for surgical implant into the body, or any other application in which the failure or lack of desired operation of the product may result in personal injury, death, or property damage) other than those expressly set forth in applicable Littelfuse® product documentation. Warranties granted by Littelfuse® shall be deemed void for products used for any purpose not expressly set forth in applicable Littelfuse® documentation. Littelfuse® shall not be liable for any claims or damages arising out of products used in applications not expressly intended by Littelfuse® as set forth in applicable Littelfuse® documentation. The sale and use of Littelfuse® products is subject to Littelfuse Terms and Conditions of Sale, unless otherwise agreed by Littelfuse®.

High Current Fuses

MEGA® High Performance Fuse Rated 70V-SF51

Dimensions

Dimensions in mm for reference only.
See outline drawing for dimensions and tolerances.

MEGA HP SF51 2 Holes M8/M6 versions

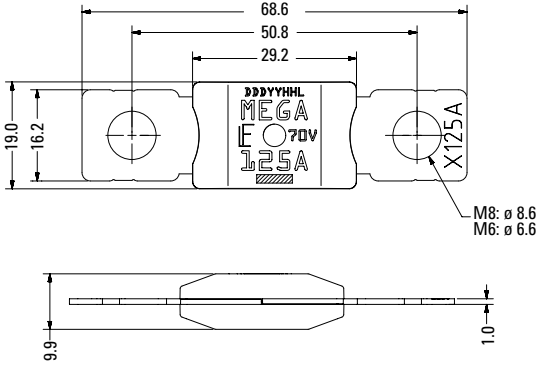

MEGA HP SF51 1 Hole M8/M6 versions

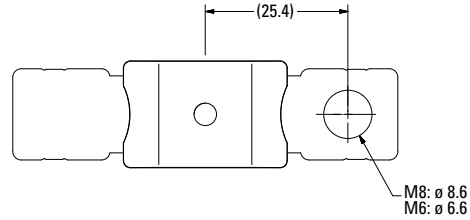

MEGA HP SF51 No-Holes version

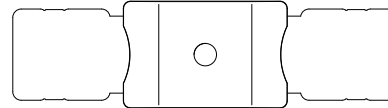

Typical Derating Of Fuse Melting Element

Temperature Security Margin is 20%
Please Contact Littelfuse For Details Regarding Derating Test Set Up

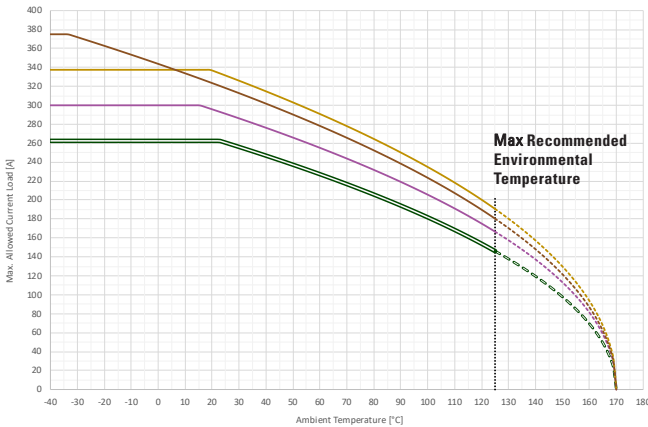
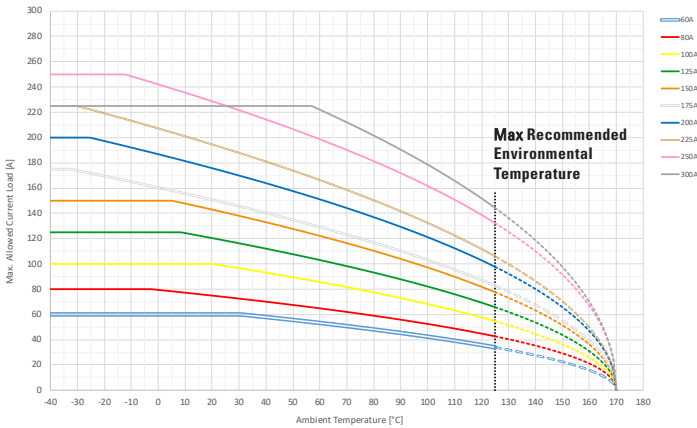

Temperature Table

	max. allowed current load [A] at ambient temperature						
	-40°C	0°C	20°C	65°C	85°C	110°C	125°C
60A	60	60	60	52	47	39	34
80A	80	79	75	63	57	49	43
100A	100	100	100	84	75	63	55
125A	125	125	120	101	90	76	66
150A	150	150	143	119	107	90	78
175A	175	160	151	126	114	95	83
200A	200	187	176	148	133	112	98
225A	225	207	195	163	146	123	106
250A	250	242	229	194	177	151	132
300A	225	225	225	217	196	166	144
350A	263	263	263	222	200	168	146
400A	300	300	296	250	226	191	167
450A	338	338	337	285	257	218	191
500A	375	344	323	272	246	207	180

Derating curves may change depending on the final condition of the application (terminals characteristics, wire size etc.).
Please ask Littelfuse® for more information.

REV07272021

Littelfuse® products are not designed for, and shall not be used for, any purpose (including, without limitation, automotive, military, aerospace, medical, life-saving, life-sustaining or nuclear facility applications, devices intended for surgical implant into the body, or any other application in which the failure or lack of desired operation of the product may result in personal injury, death, or property damage) other than those expressly set forth in applicable Littelfuse® product documentation. Warranties granted by Littelfuse® shall be deemed void for products used for any purpose not expressly set forth in applicable Littelfuse® documentation. Littelfuse® shall not be liable for any claims or damages arising out of products used in applications not expressly intended by Littelfuse® as set forth in applicable Littelfuse® documentation. The sale and use of Littelfuse® products is subject to Littelfuse Terms and Conditions of Sale, unless otherwise agreed by Littelfuse®.