

SP3423, 0.2pF, +/-10kV Diode Array

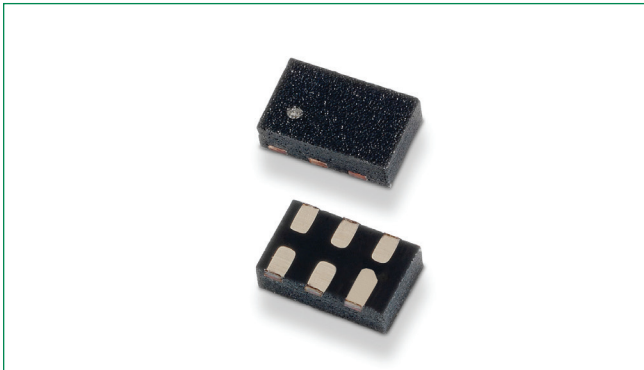

Pinout

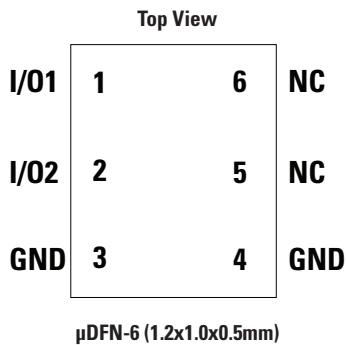

Functional Block Diagram

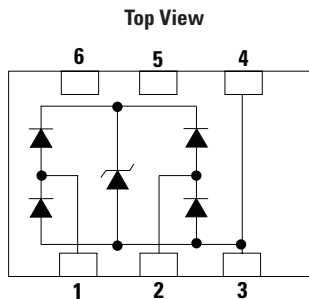

Applications

- LCD/PDP TVs
- External Storages
- DVD/Blu-ray Players
- Set Top Boxes
- Smartphones
- Ultrabooks/Notebooks
- Digital Cameras
- Portable Medical
- Automotive Electronics
- Wearable Technology
- USB 2.0/3.0
- Ethernet up to 10GbE

Description

The SP3423 integrates 2 channels of low capacitance steering diodes and an avalanche breakdown diode to provide protection for electronic equipment that may experience destructive electrostatic discharges (ESD). The SP3423 can safely absorb repetitive ESD strikes above the maximum contact level specified in IEC 61000-4-2 international standard ($\pm 8\text{kV}$ contact discharge) without performance degradation.

The low off-state capacitance makes it ideal for protecting high-speed signal lines such as USB2.0/3.0 and 10GbE interfaces with an extremely low dynamic resistance to protect the most sensitive, state of the art chipsets against ESD transients.

Its flow-through capability makes this SP3423 TVS a PCB layout friendly component and helps reduce stray PCB capacitances.

Features

- ESD, IEC 61000-4-2, $\pm 10\text{kV}$ contact, $\pm 15\text{kV}$ air
- EFT, IEC 61000-4-4, 80A ($t_p=5/50\text{ns}$)
- Lightning, 2A (8/20 μs as defined in IEC 61000-4-5 2nd edition)
- Low capacitance of 0.2pF (TYP) per I/O
- Low leakage current of 0.01 μA (TYP) at 5V
- Small $\mu\text{DFN-6}$ footprint (1.2 mm x 1.0 mm x 0.5 mm)
- AEC-Q101 qualified
- Moisture Sensitivity Level(MSL -1)
- Halogen free, lead free and RoHS compliant

USB 2.0/3.0 Protection Application Example

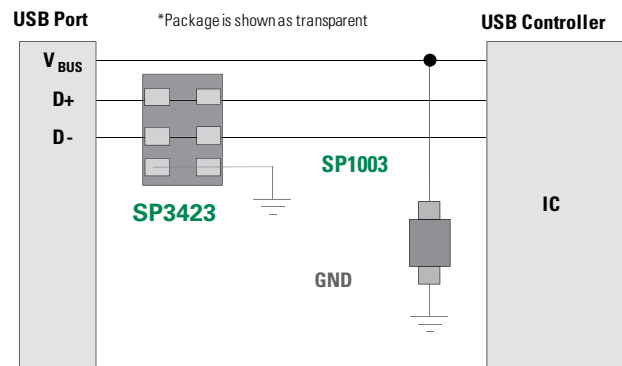

Life Support Note:

Not Intended for Use in Life Support or Life Saving Applications

The products shown herein are not designed for use in life sustaining or life saving applications unless otherwise expressly indicated.

Absolute Maximum Ratings

Symbol	Parameter	Value	Units
I_{PP}	Peak Current ($t_p=8/20\mu s$)	2	A
T_{OP}	Operating Temperature	-40 to 125	°C
T_{STOR}	Storage Temperature	-55 to 150	°C

CAUTION: Stresses above those listed in "Absolute Maximum Ratings" may cause permanent damage to the component. This is a stress only rating and operation of the component at these or any other conditions above those indicated in the operational sections of this specification is not implied.

Electrical Characteristics ($T_{OP}=25^\circ C$)

Parameter	Symbol	Test Conditions	Min	Typ	Max	Units
Reverse Standoff Voltage	V_{RWM}	$I_R = 1\mu A$			5.0	V
Breakdown Voltage	V_{BR}	$I_R = 1mA$	7	8.4		V
Reverse Leakage Current	I_{LEAK}	$V_R=5V$, Any I/O to GND		0.01	0.5	μA
Clamp Voltage ¹	V_C	$I_{PP}=1A$, $t_p=8/20\mu s$, Fwd		10.4	13	V
		$I_{PP}=2A$, $t_p=8/20\mu s$, Fwd		12.3	15	V
Dynamic Resistance ²	R_{DYN}	TLP, $t_p=100ns$, I/O to GND		0.65		Ω
ESD Withstand Voltage ¹	V_{ESD}	IEC 61000-4-2 (Contact)	± 10			kV
		IEC 61000-4-2 (Air)	± 15			kV
Diode Capacitance	$C_{I/O-GND}$	Reverse Bias=0V, f=3 GHz		0.2		μF
	$C_{I/O-I/O}$			0.1		

Note:

- Parameter is guaranteed by design and/or component characterization.
- Transmission Line Pulse (TLP) with 100ns width, 2ns rise time, and average window $t1=70ns$ to $t2=90ns$

8/20 μs Pulse Waveform

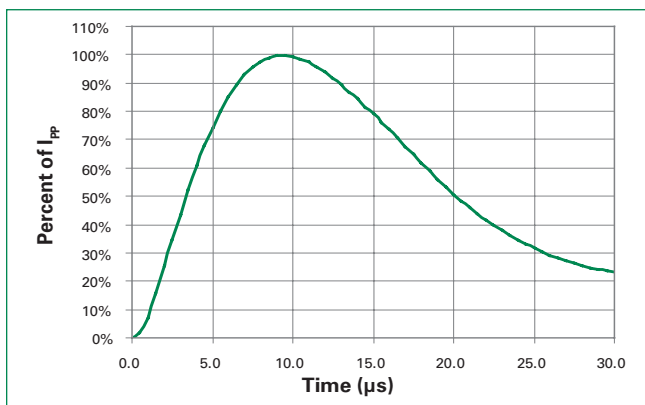

Clamping voltage vs. I_{PP} for 8/20 μs waveshape

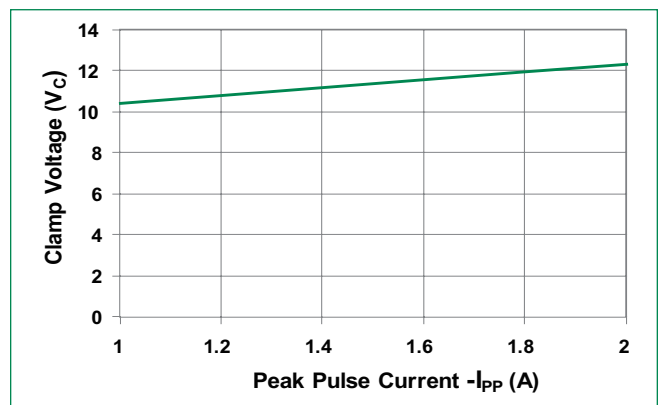

Positive Transmission Line Pulsing (TLP) Plot

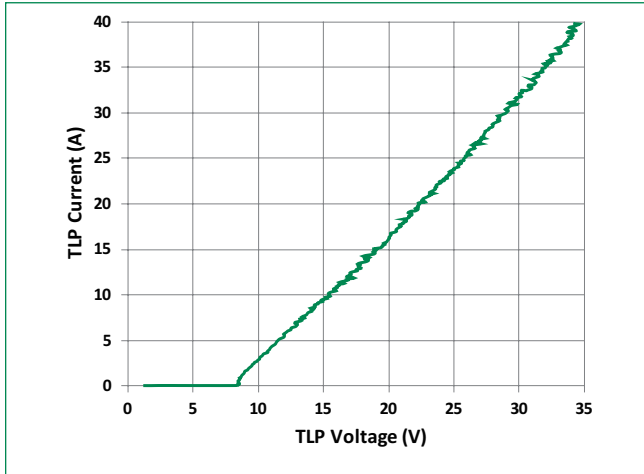

Negative Transmission Line Pulsing (TLP) Plot

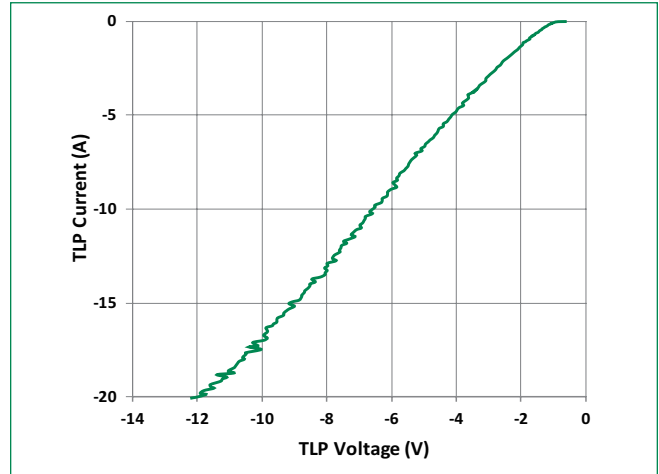

IEC 61000-4-2 +8 kV Contact ESD Clamping Voltage

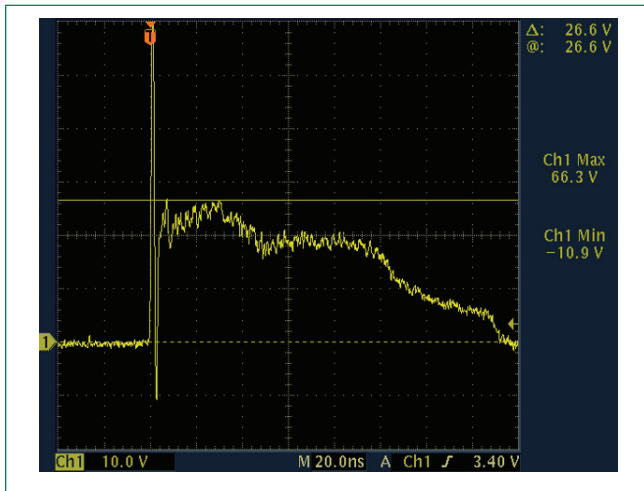

IEC 61000-4-2 -8 kV Contact ESD Clamping Voltage

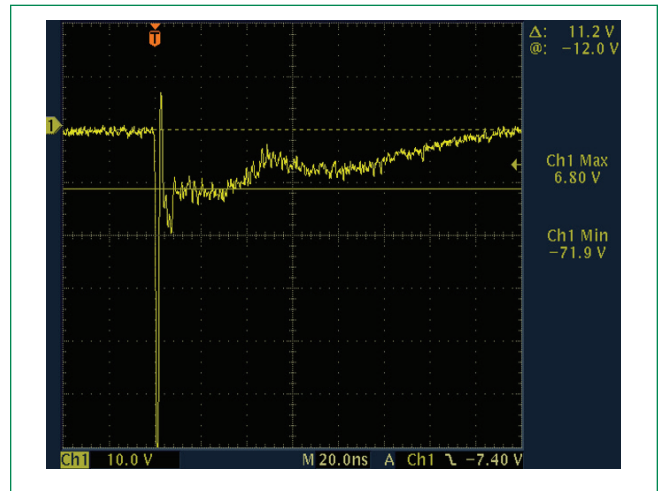

Soldering Parameters

Reflow Condition		Pb – Free assembly
Pre Heat	- Temperature Min ($T_{s(min)}$)	150°C
	- Temperature Max ($T_{s(max)}$)	200°C
	- Time (min to max) (t_s)	60 – 180 secs
Average ramp up rate (Liquidus) Temp (T_L) to peak		3°C/second max
$T_{s(max)}$ to T_L - Ramp-up Rate		3°C/second max
Reflow	- Temperature (T_L) (Liquidus)	217°C
	- Temperature (t_t)	60 – 150 seconds
Peak Temperature (T_p)		260 ^{+0/-5} °C
Time within 5°C of actual peak Temperature (t_p)		20 – 40 seconds
Ramp-down Rate		6°C/second max
Time 25°C to peak Temperature (T_p)		8 minutes Max.
Do not exceed		260°C

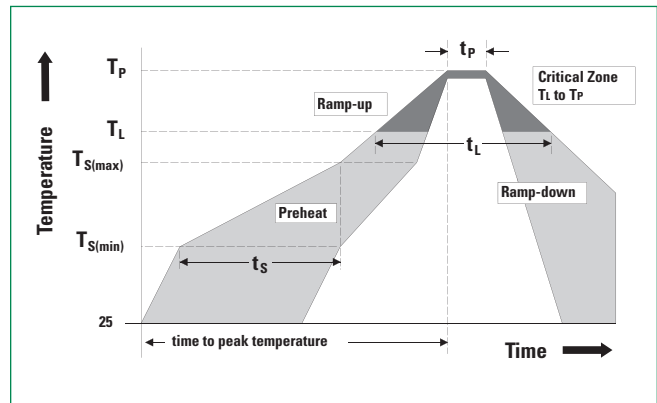

Ordering Information

Part Number	Package	Min. Order Qty.
SP3423-02UTG	μDFN-6L	3000

Part Numbering System

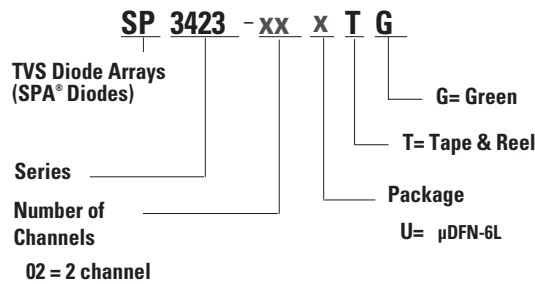

Part Marking System

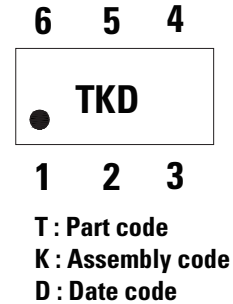

Product Characteristics

Lead Plating	Pre-Plated Frame (μDFN)
Lead Material	Copper Alloy
Substrate Material	Silicon
Body Material	Molded Compound
Flammability	UL Recognized compound meeting flammability rating V-0

Package Dimensions – μDFN-6L

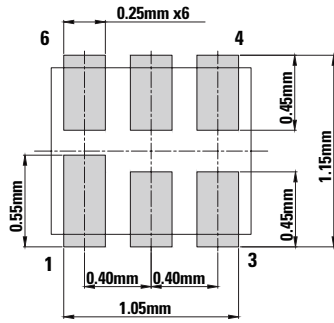
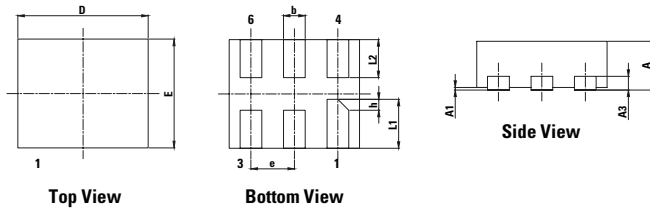

Recommended Soldering Pad Layout
Drawing#: U02-A

μDFN6 (1.2x1.0x0.45mm)						
JEDEC MO-229						
Symbol	Millimeters			Inches		
	Min	Nom	Max	Min	Nom	Max
A	0.40	0.45	0.50	0.016	0.018	0.020
A1	0.00	0.02	0.05	0.000	0.001	0.002
A3	0.125 REF			0.005 REF		
b	0.15	0.20	0.25	0.006	0.008	0.010
D	1.10	1.20	1.30	0.043	0.047	0.051
E	0.90	1.00	1.10	0.035	0.039	0.043
e	0.40 REF			0.016 BSC		
L1	0.35	0.45	0.55	0.014	0.018	0.022
L2	0.25	0.35	0.45	0.010	0.014	0.018
h	0.10 REF			0.004 REF		

Embossed Carrier Tape & Reel Specification – μDFN-6L

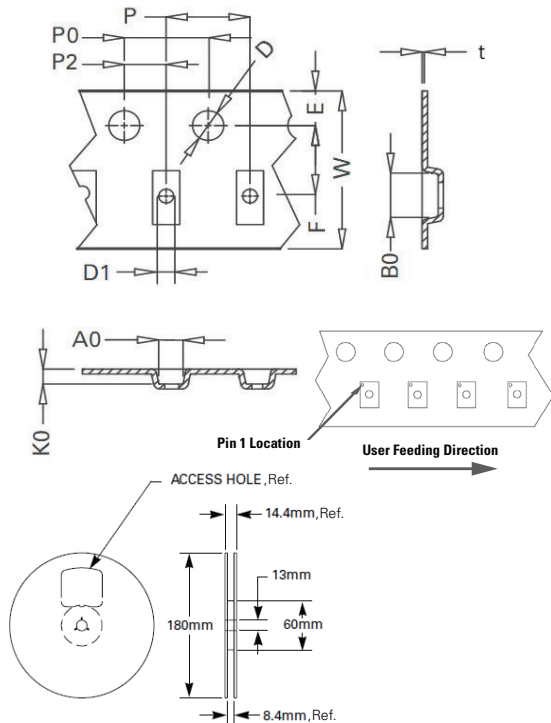

8mm TAPE AND REEL

Symbol	Millimeters		Inches	
	Min	Max	Min	Max
E	1.65	1.85	0.064	0.073
F	3.45	3.55	0.135	0.139
P2	1.95	2.05	0.076	0.081
D	1.40	1.60	0.055	0.063
D1	0.45	0.55	0.017	0.021
P	3.90	4.10	0.154	0.161
10P0	40.0+/-0.20		1.574+/-0.008	
W	7.90	8.30	0.311	0.319
P0	3.90	4.10	0.154	0.161
A0	1.15	1.25	0.045	0.049
B0	1.75	1.85	0.069	0.073
K0	0.65	0.75	0.026	0.03
t	0.22 max		0.009 max	

Disclaimer Notice - Littelfuse products are not designed for, and shall not be used for, any purpose (including, without limitation, automotive, military, aerospace, medical, life-saving, life-sustaining or nuclear facility applications, devices intended for surgical implant into the body, or any other application in which the failure or lack of desired operation of the product may result in personal injury, death, or property damage) other than those expressly set forth in applicable Littelfuse product documentation. Warranties granted by Littelfuse shall be deemed void for products used for any purpose not expressly set forth in applicable Littelfuse documentation. Littelfuse shall not be liable for any claims or damages arising out of products used in applications not expressly intended by Littelfuse as set forth in applicable Littelfuse documentation. The sale and use of Littelfuse products is subject to Littelfuse Terms and Conditions of Sale, unless otherwise agreed by Littelfuse. "Littelfuse" includes Littelfuse, Inc., and all of its affiliate entities. <http://www.littelfuse.com/disclaimer-electronics>