

SP1064E

14.0pF, 25kV Diode Array, General Purpose ESD Protection



Note: This package image is for example and reference only. For detail package drawing, please refer to the package section in this datasheet.

Pinout

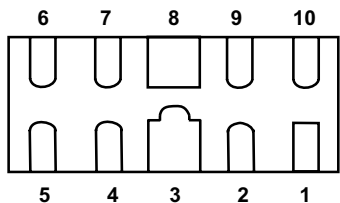

*Pins 6, 7, 9, 10 are not internally connected but should be connected to the trace.

Functional Block Diagram

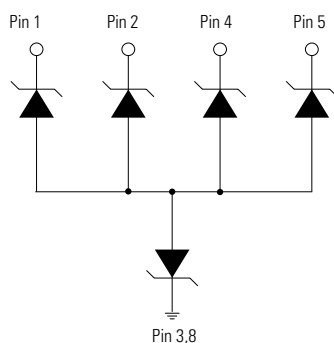

Description

The SP1064E is an avalanche breakdown diode fabricated in a proprietary silicon avalanche technology protect each I/O pin to provide a high level of protection for electronic equipment that may experience destructive electrostatic discharges (ESD). These robust diodes can safely absorb repetitive ESD strikes above the maximum level specified in IEC 61000-4-2 international standard (Level 4, $\pm 8\text{kV}$ contact discharge) without performance degradation.

Features & Benefits

- ESD, IEC 61000-4-2, $\pm 25\text{kV}$ contact, $\pm 30\text{kV}$ air
- EFT, IEC 61000-4-4, 40A (5/50ns)
- Surge tolerance, IEC 61000-4-5 2nd Edition, 3.5A (8/20us)
- Low capacitance of 14.0pF (TYP) per I/O
- Low leakage current of 0.05 μA (TYP) at 60V
- Small form factor μDFN (JEDEC MO-229) package saves board space
- Halogen free, Lead free and RoHS compliant
- Moisture Sensitivity Level (MSL -1)

Applications

- LCD/PDP TVs
- DVD Players
- Desktops
- MP3/PMP
- Set Top Boxes
- Mobile Phones
- Notebooks
- Digital Cameras

Life Support Note:

Not Intended for Use in Life Support or Life Saving Applications

The products shown herein are not designed for use in life sustaining or life saving applications unless otherwise expressly indicated.

SP1064E**14.0pF, 25kV Diode Array, General Purpose ESD Protection****Absolute Maximum Ratings**

Symbol	Parameter	Value	Units
I_{PP}	Peak Current ($t_p=8/20\mu s$)	3.5	A
T_{OP}	Operating Temperature	-40 to 125	°C
T_{STOR}	Storage Temperature	-55 to 150	°C

Caution: Stresses above those listed in "Absolute Maximum Ratings" may cause permanent damage to the component. This is a stress only rating and operation of the component at these or any other conditions above those indicated in the operational sections of this specification is not implied.

Electrical Characteristics ($T_{OP}=25^\circ C$)

Parameter	Symbol	Test Conditions	Min	Typ	Max	Units
Reverse Standoff Voltage	V_{RWM}	$I_R=1\mu A$			60	V
Breakdown Voltage	V_{BR}	$I_R=1mA$	62	68	73	V
Reverse Leakage Current	I_{LEAK}	$V_R=60V$, Any I/O to GND		0.05		μA
Clamp Voltage ¹	V_C	$I_{PP}=1A$, $t_p=8/20\mu s$		81		V
		$I_{PP}=3.5A$, $t_p=8/20\mu s$		102		
Dynamic Resistance ³	R_{DYN}	TLP, $t_p=100ns$		2.6		Ω
ESD Withstand Voltage ¹	V_{ESD}	IEC 61000-4-2 (Contact Discharge)	± 25			kV
		IEC 61000-4-2 (Air Discharge)	± 30			kV
Line Capacitance ^{1,2}	C_L	Reverse Bias=0V, $f=1MHz$		14.0		pF

Note 1: Parameter is guaranteed by design and/or component characterization.

Note 2: Test equipment accuracy $\pm 50\%$.

Note 3: Transmission Line Pulse (TLP) with 100ns width, 2ns rise time, and average window $t1=70ns$ to $t2=90ns$

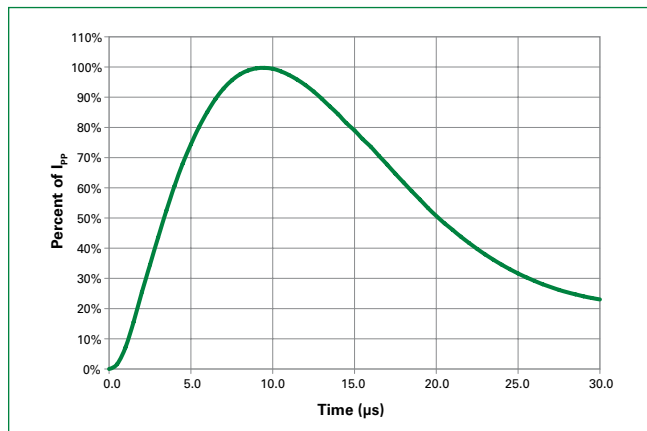
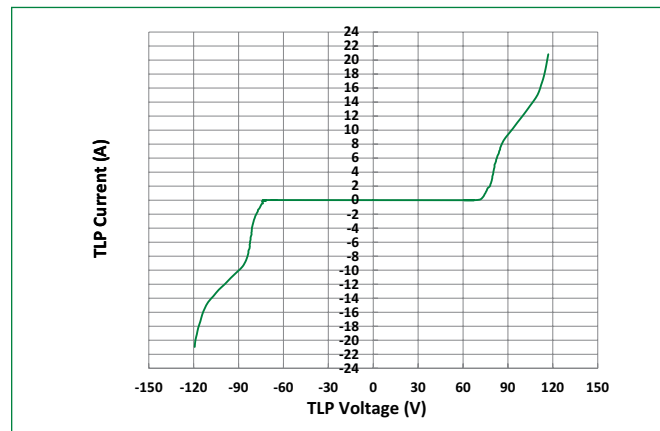
8/20 μs Pulse Waveform**Transmission Line Pulsing (TLP) Plot**

SP1064E

14.0pF, 25kV Diode Array, General Purpose ESD Protection

Clamping Voltage vs. I_{pp}

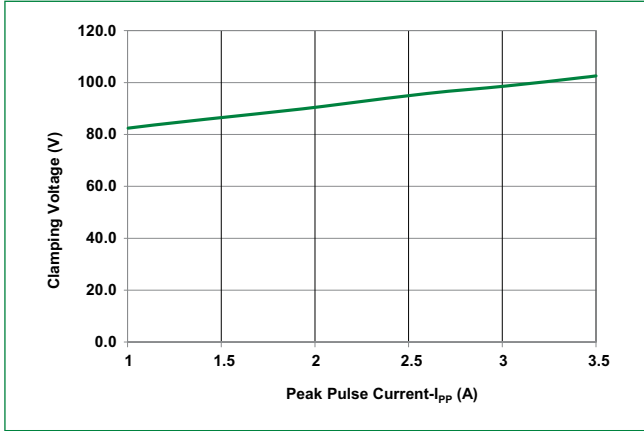

Capacitance vs. Reverse Bias

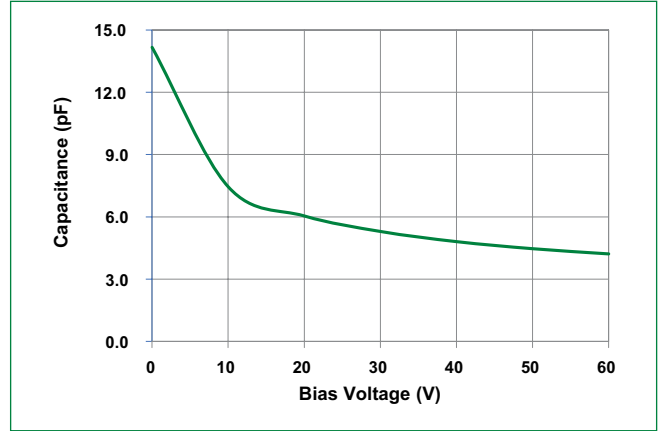

IEC 61000-4-2 +8 kV Contact ESD Clamping Voltage

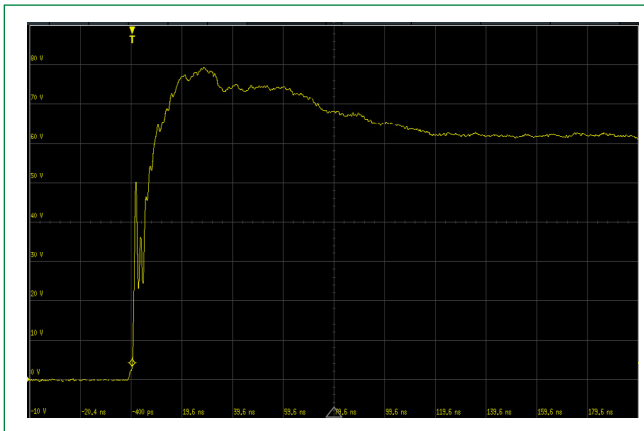

IEC 61000-4-2 -8 kV Contact ESD Clamping Voltage

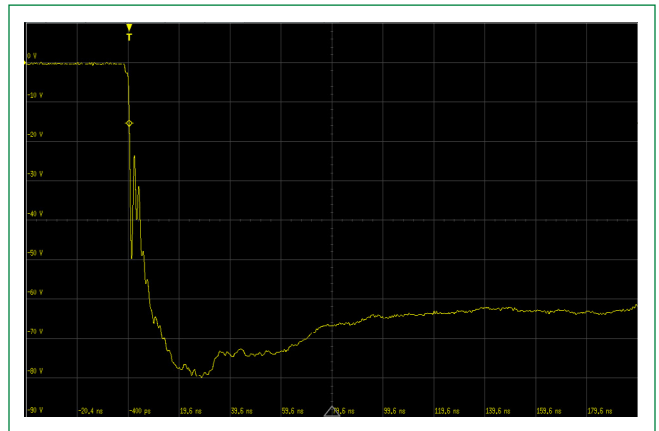

SP1064E

14.0pF, 25kV Diode Array, General Purpose ESD Protection

Soldering Parameters

Reflow Condition		Pb – Free assembly
Pre Heat	- Temperature Min ($T_{s(min)}$)	150°C
	- Temperature Max ($T_{s(max)}$)	200°C
	- Time (min to max) (t_s)	60 – 120 secs
Average ramp up rate (Liquidus) Temp (T_L) to peak		3°C/second max
$T_{s(max)}$ to T_L - Ramp-up Rate		3°C/second max
Reflow	- Temperature (T_L) (Liquidus)	217°C
	- Temperature (t_L)	60 – 150 seconds
Peak Temperature (T_p)		260 ^{+0/-5} °C
Time within 5°C of actual peak Temperature (t_p)		30 seconds
Ramp-down Rate		6°C/second max
Time 25°C to peak Temperature (T_p)		8 minutes Max.
Do not exceed		260°C

Ordering Information

Part Number	Package	Min. Order Qty.
SP1064E-04UTG	μDFN-10	3000

Part Marking System

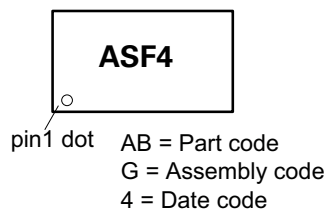

Part Numbering System

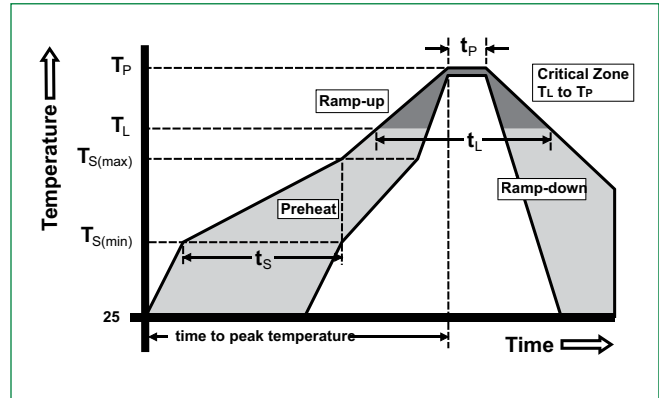
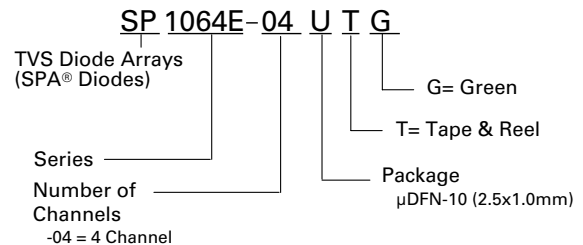

Product Characteristics

Lead Plating	Pre-Plated Frame or Tin
Lead material	Copper Alloy
Substrate Material	Silicon
Body Material	Molded Compound
Flammability	UL Recognized compound meeting flammability rating V-0

SP1064E

14.0pF, 25kV Diode Array, General Purpose ESD Protection

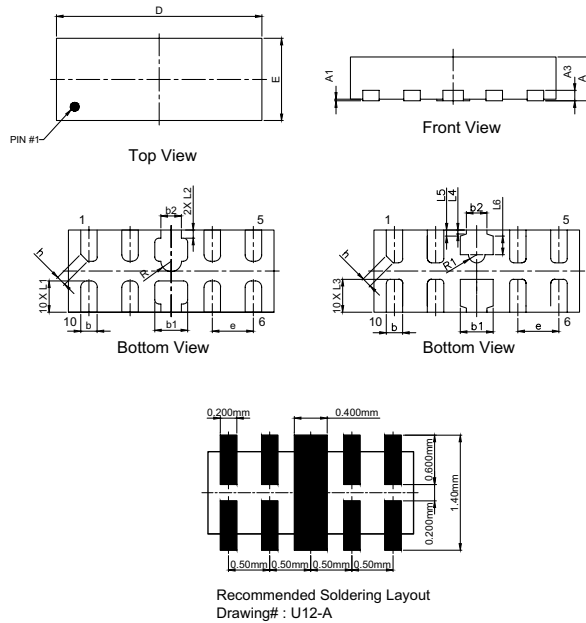
Package Dimensions — μ DFN-10 (2.5x1.0x0.5mm)

Symbol	Millimeters		Inches	
	Min	Max	Min	Max
A	0.45	0.60	0.018	0.024
A1	0	0.05	0.000	0.002
A3	0.12	0.175	0.005	0.007
b	0.15	0.25	0.006	0.010
b1	0.35	0.45	0.014	0.018
b2	0.20	0.30	0.008	0.012
D	2.40	2.60	0.094	0.102
E	0.90	1.10	0.035	0.043
L1	0.28	0.48	0.011	0.019
L2	0.05	0.15	0.002	0.006
L3	0.35	0.45	0.014	0.018
L4	0.05 REF		0.002 REF	
L5	0.075 REF		0.003 REF	
L6	0.225 REF		0.009 REF	
e	0.500 BSC		0.020 BSC	
R	0.125 REF		0.005 REF	
R1	0.100 REF		0.004 REF	
h	0.08	0.16	0.003	0.006

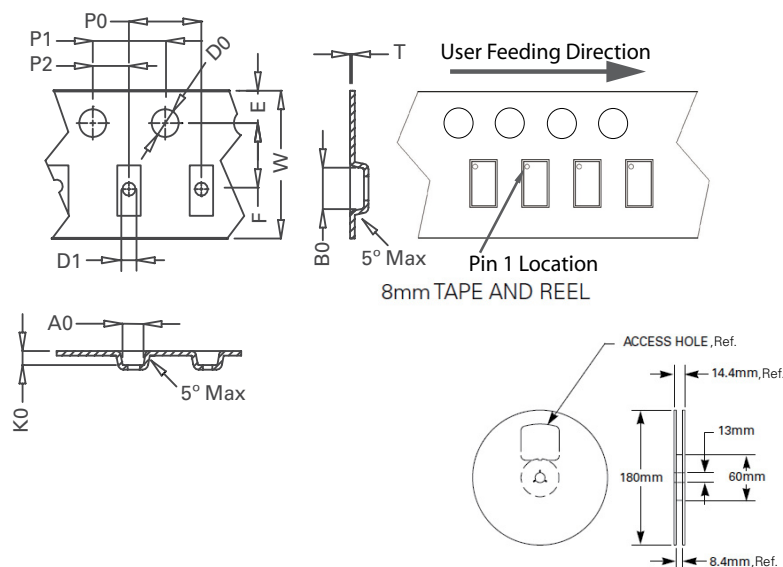
Embossed Carrier Tape & Reel Specification — μ DFN-10

Package	μ DFN-10 (2.5x1.0x0.5mm)
Symbol	Millimeters
A0	1.30 +/- 0.10
B0	2.83 +/- 0.10
D0	\varnothing 1.50 + 0.10
D1	\varnothing 1.00 + 0.25
E	1.75 +/- 0.10
F	3.50 +/- 0.05
K0	0.65 +/- 0.10
P0	4.00 +/- 0.10
P1	4.00 +/- 0.10
P2	2.00 +/- 0.05
T	0.254 +/- 0.02
W	8.00 + 0.30 /- 0.10

Product Disclaimer: Littelfuse products are not designed for, and shall not be used for, any purpose (including, without limitation, automotive, military, aerospace, medical, life-saving, life-sustaining or nuclear facility applications, devices intended for surgical implant into the body, or any other application in which the failure or lack of desired operation of the product may result in personal injury, death, or property damage) other than those expressly set forth in applicable Littelfuse product documentation. Warranties granted by Littelfuse shall be deemed void for products used for any purpose not expressly set forth in applicable Littelfuse documentation. Littelfuse shall not be liable for any claims or damages arising out of products used in applications not expressly intended by Littelfuse as set forth in applicable Littelfuse documentation. The sale and use of Littelfuse products is subject to Littelfuse Terms and Conditions of Sale, unless otherwise agreed by Littelfuse. "Littelfuse" includes Littelfuse, Inc., and all of its affiliate entities. <http://www.littelfuse.com/disclaimer-electronics>.