

SD Series

450W Discrete Unidirectional TVS Diode



Description

The Unidirectional SD series is designed for use in electronic equipment for low speed and DC applications. It will protect any sensitive equipment from damage due to electrostatic discharge (ESD) and other transient events.

The SD series can safely absorb repetitive ESD strikes at $\pm 30\text{kV}$ (contact discharge, IEC 61000-4-2) without performance degradation and safely dissipate 30A (SD05) of 8/20 μs induced surge current (IEC61000-4-5 2nd edition) with very low clamping voltages.

Features & Benefits

- ESD, IEC 61000-4-2, $\pm 30\text{kV}$ contact, $\pm 30\text{kV}$ air
- EFT, IEC 61000-4-4, 40A (5/50ns)
- Lightning, 30A (8/20 μs as defined in IEC 61000-4-5 2nd edition) SD05
- Low clamping voltage
- Low leakage current
- Small SOD323 package fits 0805 footprints
- AEC-Q101 qualified
- RoHS Compliant and Lead Free
- Moisture Sensitivity Level

Additional Information



Resources



Accessories



Samples

Pinout and Functional Block Diagram

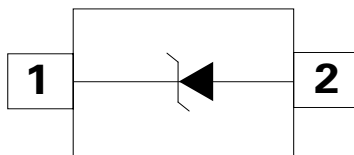

Applications

- Switches / Buttons
- Test Equipment / Instrumentation
- Point-of-Sale Terminals
- Medical Equipment
- Notebooks / Desktops / Servers
- Computer Peripherals
- Automotive Electronics

Life Support Note:

Not Intended for Use in Life Support or Life Saving Applications

The products shown herein are not designed for use in life sustaining or life saving applications unless otherwise expressly indicated.

SD Series

450W Discrete Unidirectional TVS Diode

Absolute Maximum Ratings

Symbol	Parameter	Value	Units
P_{pk}	Peak Pulse Power ($t_p=8/20\mu s$)	450	W
T_{OP}	Operating Temperature	-40 to 125	°C
T_{STOR}	Storage Temperature	-55 to 150	°C

Caution: Stresses above those listed in "Absolute Maximum Ratings" may cause permanent damage to the device. This is a stress only rating and operation of the device at these or any other conditions above those indicated in the operational sections of this specification is not implied.

SD05 Electrical Characteristics ($T_{OP}=25^\circ C$)

Parameter	Symbol	Test Conditions	Min	Typ	Max	Units
Reverse Standoff Voltage	V_{BR}	$I_R=1\mu A$	-	-	5.0	V
Breakdown Voltage	V_{BR}	$I_R=1mA$	6.0	-	-	V
Reverse Leakage Current	I_{LEAK}	$V_R=5V$	-	-	1.0	μA
Clamp Voltage ¹	V_C	$I_{PP}=1A, t_p=8/20\mu s, Fwd$	-	-	9.8	V
		$I_{PP}=10A, t_p=8/20\mu s, Fwd$	-	-	13.0	V
Dynamic Resistance ²	R_{DYN}	TLP, $t_p=100ns$, I/O to Ground	-	0.22	-	Ω
Peak Pulse Current	I_{PP}	$t_p=8/20\mu s$	-	-	30.0	A
ESD Withstand Voltage ¹	V_{ESD}	IEC 61000-4-2 (Contact Discharge)	± 30	-	-	kV
		IEC 61000-4-2 (Air Discharge)	± 30	-	-	kV
Diode Capacitance ¹	$C_{I/O-GND}$	Reverse Bias=0V, $f=1MHz$	-	-	350	pF

SD12 Electrical Characteristics ($T_{OP}=25^\circ C$)

Parameter	Symbol	Test Conditions	Min	Typ	Max	Units
Reverse Standoff Voltage	V_{RWM}	$I_R=1\mu A$	-	-	12.0	V
Breakdown Voltage	V_{BR}	$I_R=1mA$	13.3	-	-	V
Reverse Leakage Current	I_{LEAK}	$V_R=12V$	-	-	1.0	μA
Clamp Voltage ¹	V_C	$I_{PP}=1A, t_p=8/20\mu s, Fwd$	-	-	18.5	V
		$I_{PP}=10A, t_p=8/20\mu s, Fwd$	-	-	22.5	V
Dynamic Resistance ²	R_{DYN}	TLP, $t_p=100ns$, I/O to Ground	-	0.29	-	Ω
Peak Pulse Current	I_{PP}	$t_p=8/20\mu s$	-	-	17.0	A
ESD Withstand Voltage ¹	V_{ESD}	IEC 61000-4-2 (Contact Discharge)	± 30	-	-	kV
		IEC 61000-4-2 (Air Discharge)	± 30	-	-	kV
Diode Capacitance ¹	$C_{I/O-GND}$	Reverse Bias=0V, $f=1MHz$	-	-	150	pF

SD Series

450W Discrete Unidirectional TVS Diode

SD15 Electrical Characteristics (T_{OP}=25°C)

Parameter	Symbol	Test Conditions	Min	Typ	Max	Units
Reverse Standoff Voltage	V _{RWM}	I _R =1μA			15.0	V
Breakdown Voltage	V _{BR}	I _R =1mA	16.7			V
Reverse Leakage Current	I _{LEAK}	V _R =15V			1.0	μA
Clamp Voltage ¹	V _C	I _{PP} =1A, t _p =8/20μs, Fwd			24.0	V
		I _{PP} =10A, t _p =8/20μs, Fwd			30.0	V
Dynamic Resistance ²	R _{DYN}	TLP, t _p =100ns, I/O to Ground		0.34		Ω
Peak Pulse Current	I _{PP}	t _p =8/20μs			12.0	A
ESD Withstand Voltage ¹	V _{ESD}	IEC 61000-4-2 (Contact Discharge)	±30			kV
		IEC 61000-4-2 (Air Discharge)	±30			kV
Diode Capacitance ¹	C _{I/O-GND}	Reverse Bias=0V, f=1MHz			100	pF

SD24 Electrical Characteristics (T_{OP}=25°C)

Parameter	Symbol	Test Conditions	Min	Typ	Max	Units
Reverse Standoff Voltage	V _{RWM}	I _R =1μA			24.0	V
Breakdown Voltage	V _{BR}	I _R =1mA	26.7			V
Reverse Leakage Current	I _{LEAK}	V _R =24V			1.0	μA
Clamp Voltage ¹	V _C	I _{PP} =1A, t _p =8/20μs, Fwd			36.0	V
		I _{PP} =5A, t _p =8/20μs, Fwd			42.0	V
Dynamic Resistance ²	R _{DYN}	TLP, t _p =100ns, I/O to Ground		0.49		Ω
Peak Pulse Current	I _{PP}	t _p =8/20μs			7.0	A
ESD Withstand Voltage ¹	V _{ESD}	IEC 61000-4-2 (Contact Discharge)	±30			kV
		IEC 61000-4-2 (Air Discharge)	±30			kV
Diode Capacitance ¹	C _{I/O-GND}	Reverse Bias=0V, f=1MHz			65	pF

SD36 Electrical Characteristics (T_{OP}=25°C)

Parameter	Symbol	Test Conditions	Min	Typ	Max	Units
Reverse Standoff Voltage	V _{RWM}	I _R =1μA			36.0	V
Breakdown Voltage	V _{BR}	I _R =1mA	40.0			V
Reverse Leakage Current	I _{LEAK}	V _R =36V			1.0	μA
Clamp Voltage ¹	V _C	I _{PP} =1A, t _p =8/20μs, Fwd			52.0	V
		I _{PP} =4A, t _p =8/20μs, Fwd			62.0	V
Dynamic Resistance ²	R _{DYN}	TLP, t _p =100ns, I/O to Ground		0.61		Ω
Peak Pulse Current	I _{PP}	t _p =8/20μs			5.0	A
ESD Withstand Voltage ¹	V _{ESD}	IEC 61000-4-2 (Contact Discharge)	±30			kV
		IEC 61000-4-2 (Air Discharge)	±30			kV
Diode Capacitance ¹	C _{I/O-GND}	Reverse Bias=0V, f=1MHz			50	pF

Note:

- Parameter is guaranteed by design and/or component characterization.
- Transmission Line Pulse (TLP) with 100ns width and 200ps rise time.

SD Series

450W Discrete Unidirectional TVS Diode

Non-Repetitive Peak Pulse Power vs. Pulse Time

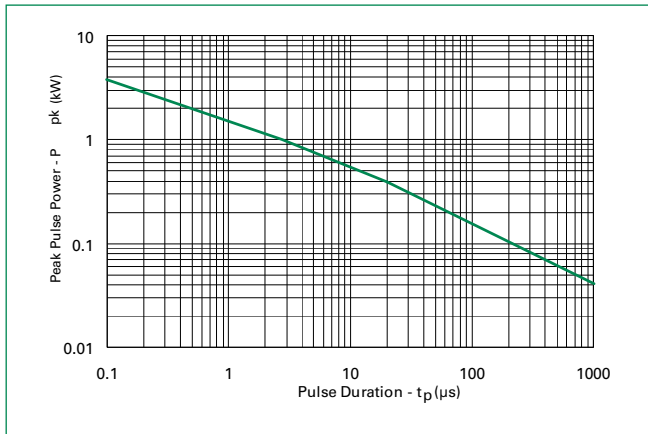

Capacitance vs. Bias

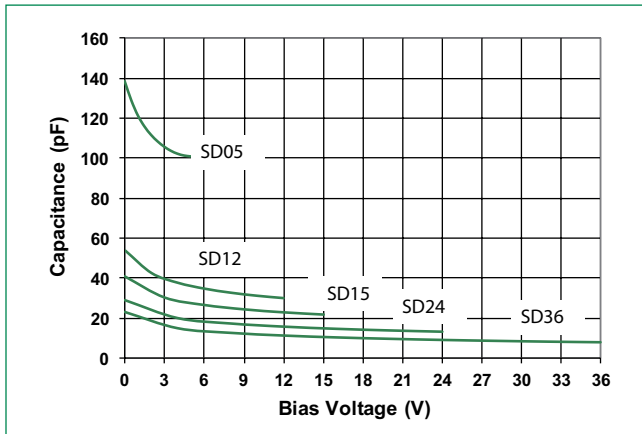

Power Derating Curve

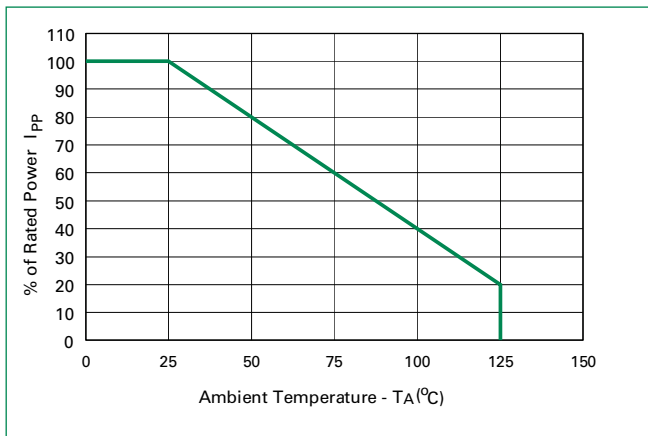

8/20 μs Pulse Waveform

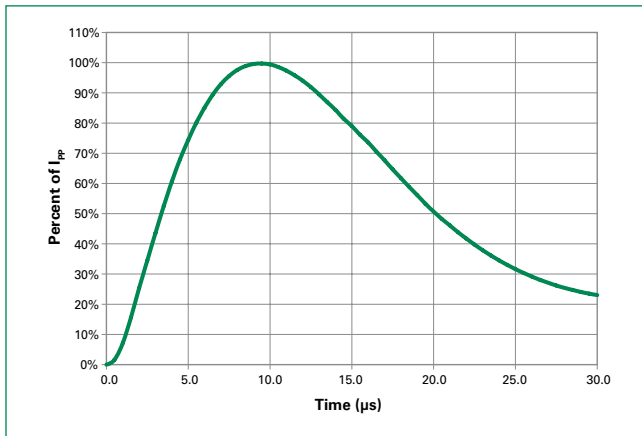

SD05 Transmission Line Pulsing(TLP) Plot

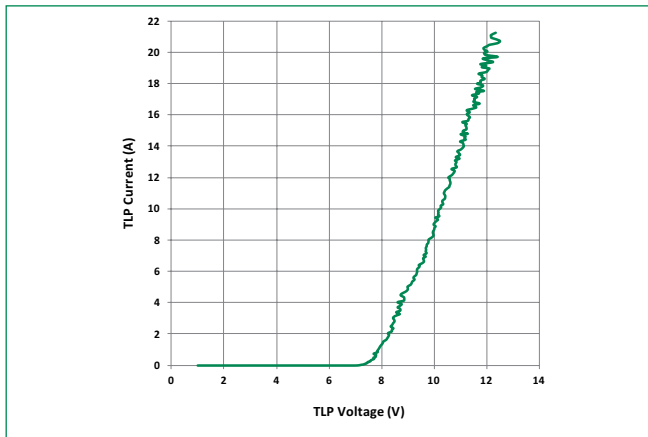

SD12 Transmission Line Pulsing(TLP) Plot

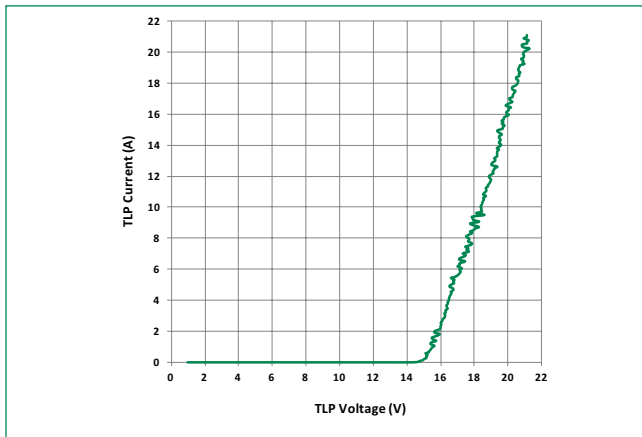

SD Series

450W Discrete Unidirectional TVS Diode

SD15 Transmission Line Pulsing(TLP) Plot

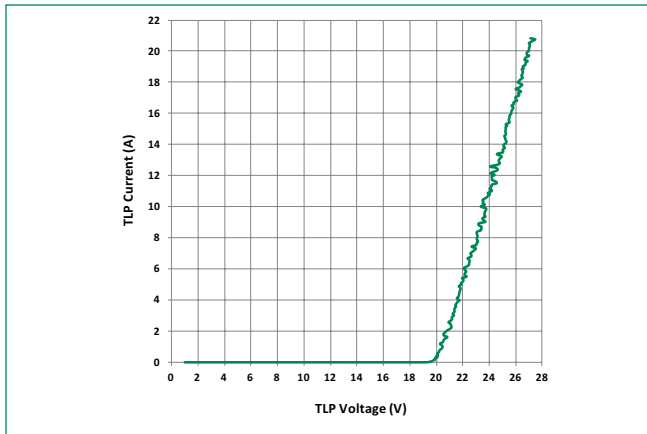

SD24 Transmission Line Pulsing(TLP) Plot

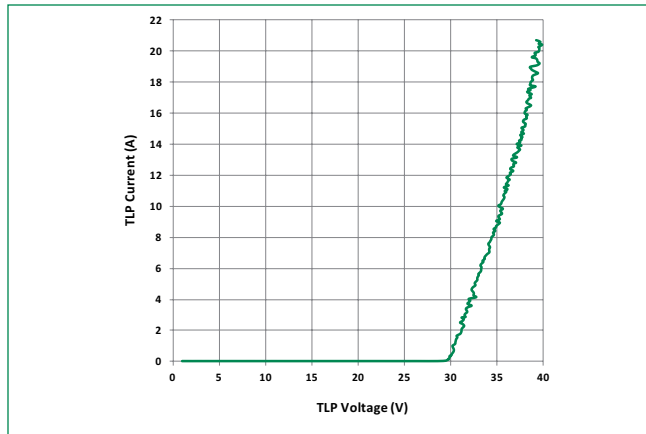

SD36 Transmission Line Pulsing(TLP) Plot

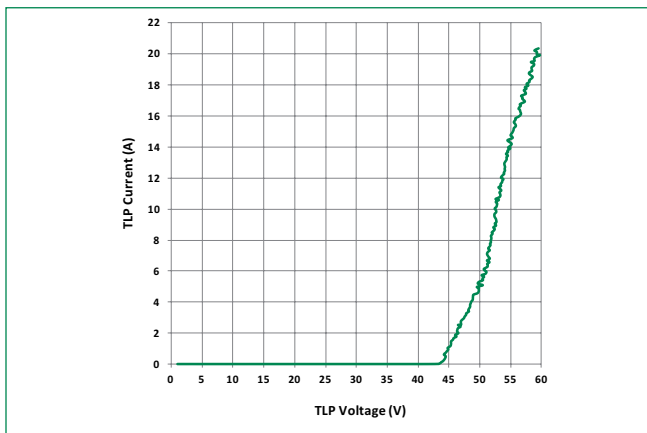

Soldering Parameters

Reflow Condition		Pb – Free assembly
Pre Heat	- Temperature Min ($T_{s(min)}$)	150°C
	- Temperature Max ($T_{s(max)}$)	200°C
	- Time (min to max) (t_s)	60 – 180 secs
Average ramp up rate (Liquidus) Temp (T_L) to peak		3°C/second max
$T_{s(max)}$ to T_L - Ramp-up Rate		3°C/second max
Reflow	- Temperature (T_L) (Liquidus)	217°C
	- Temperature (t_L)	60 – 150 seconds
Peak Temperature (T_p)		260 ^{+0/-5} °C
Time within 5°C of actual peak Temperature (t_p)		20 – 40 seconds
Ramp-down Rate		6°C/second max
Time 25°C to peak Temperature (T_p)		8 minutes Max.
Do not exceed		260°C

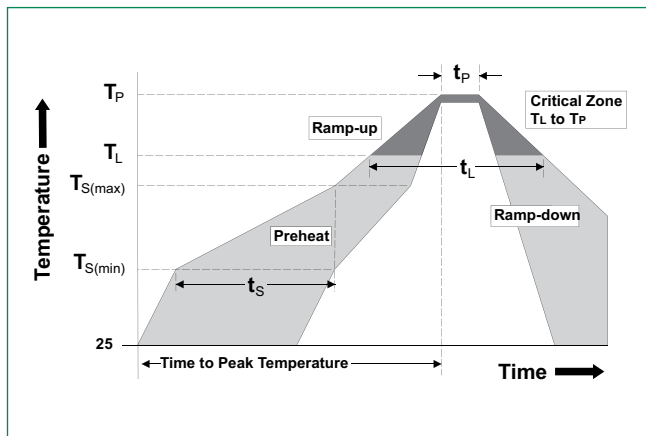

SD Series

450W Discrete Unidirectional TVS Diode

Product Characteristics

Lead Plating	Matte Tin
Lead Material	Copper Alloy
Lead Coplanarity	0.0004 inches (0.102mm)
Substrate material	Silicon
Body Material	Molded Compound
Flammability	UL Recognized compound meeting flammability rating V-0

Ordering Information

Part Number	Package	Min. Order Qty.
SD05-01FTG	SOD323	3000
SD12-01FTG	SOD323	3000
SD15-01FTG	SOD323	3000
SD24-01FTG	SOD323	3000
SD36-01FTG	SOD323	3000

Part Marking System

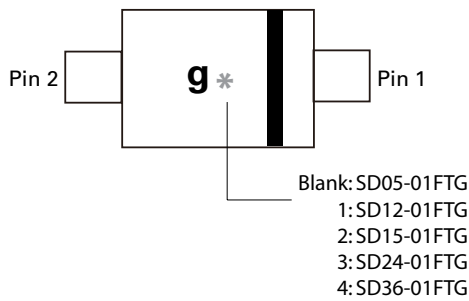

Part Numbering System

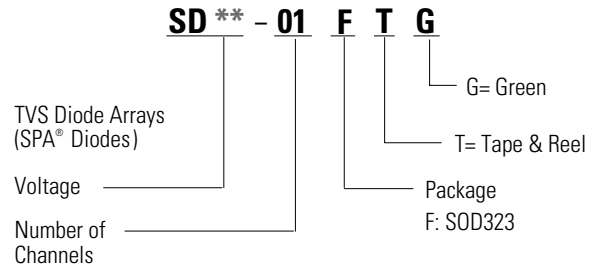

Package Dimensions -SOD323

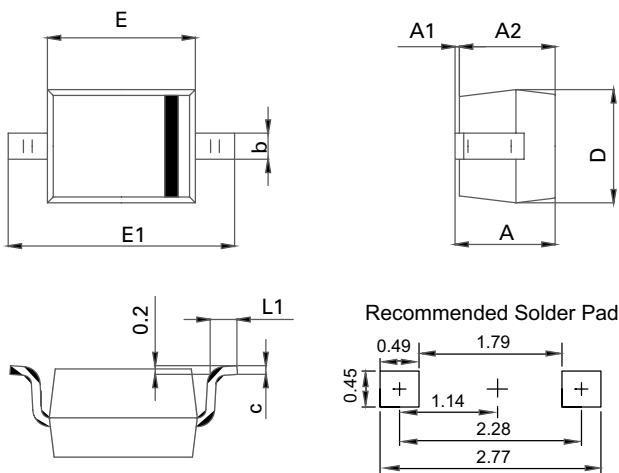

Unit: mm

Symbol	SOD323			
	Millimeters		Inches	
	Min	Max	Min	Max
A	0.8	1.14	0.031	0.045
A1	0.00	0.10	0.000	0.004
A2	0.80	1.04	0.031	0.014
b	0.25	0.35	0.010	0.014
c	0.08	0.15	0.003	0.006
D	1.15	1.45	0.045	0.057
E	1.60	1.90	0.063	0.075
E1	2.44	2.70	0.096	0.106
L1	0.25	0.45	0.010	0.018

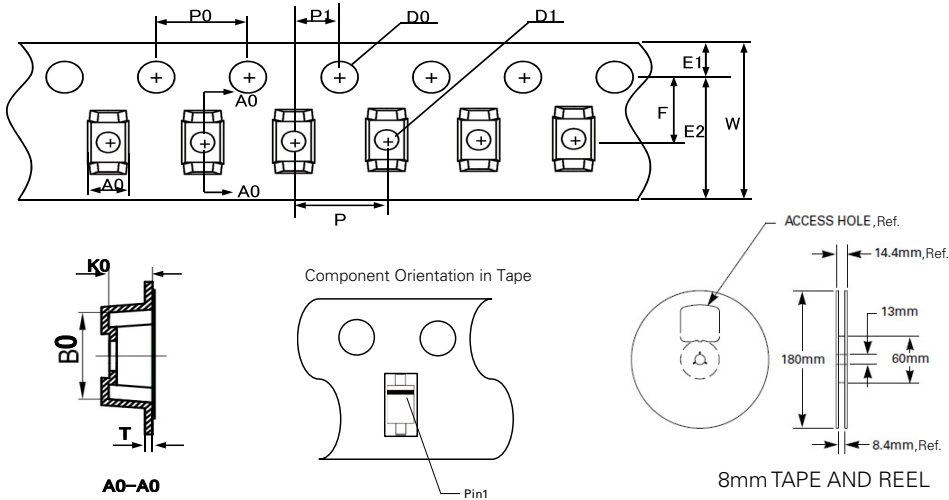
SD Series**450W Discrete Unidirectional TVS Diode****Embossed Carrier Tape & Reel Specification — SOD323**

Symbol	Millimeters
A0	1.46+/-0.10
B0	2.90+/-0.10
W	8.0+0.3/-0.10
D0	1.50+0.10
D1	0.45min/1.15max
E1	1.75+/-0.10
E2	-
F	3.50+/-0.10
P0	4.00+/-0.10
P	4.00+/-0.10
P1	2.00+/-0.05
K0	1.25+/-0.10
T	0.254+/-0.02

Disclaimer Notice - Information furnished is believed to be accurate and reliable. However, users should independently evaluate the suitability of and test each product selected for their own applications. Littelfuse products are not designed for, and may not be used in, all applications. Read complete Disclaimer Notice at www.littelfuse.com/disclaimer-electronics.