

## SP1305 30pF, 30kV TVS Diode Array



### Description

The SP1305 TVS Diode Array is designed to protect sensitive equipment from damage due to electrostatic discharge (ESD), electrical fast transients (EFT), and lightning induced surges.

The SP1305 can absorb repetitive ESD strikes above the maximum level specified in the IEC 61000-4-2 international standard without performance degradation and safely dissipate up to 5A of 8/20µs induced surge current (IEC 61000-4-5, 2<sup>nd</sup> Edition) with very low clamping voltages.

### Pinout and Functional Block Diagram

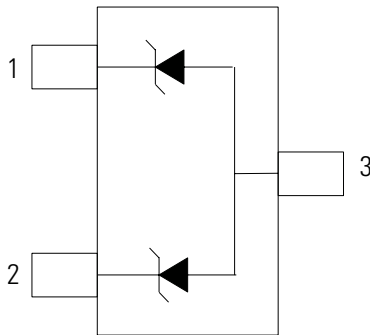

### Features

- ESD, IEC 61000-4-2, ±30kV contact, ±30kV air
- EFT, IEC 61000-4-4, 50A (5/50ns)
- Lightning, IEC 61000-4-5 2nd Edition, 5A (8/20µs)
- Low clamping voltage
- Low leakage current
- Moisture Sensitivity Level (MSL-1)
- Halogen-Free, Lead-Free and RoHS-Compliant

### Applications

- Industrial equipment
- Test and medical equipment
- Point-of-Sale terminals
- Motor controls
- Legacy ports (RS-232, RS-485)
- Security and alarm system

Life Support Note:

**Not Intended for Use in Life Support or Life Saving Applications**

The products shown herein are not designed for use in life sustaining or life saving applications unless otherwise expressly indicated.

### Absolute Maximum Ratings

Symbol	Parameter	Value	Units
$I_{PP}$	Peak Pulse Current ( $t_p=8/20\mu s$ )	5.0	A
$T_{OP}$	Operating Temperature	-40 to 125	°C
$T_{STOR}$	Storage Temperature	-55 to 150	°C

**CAUTION:** Stresses above those listed in "Absolute Maximum Ratings" may cause permanent damage to the component. This is a stress only rating and operation of the component at these or any other conditions above those indicated in the operational sections of this specification is not implied.

### Electrical Characteristics ( $T_{OP}=25^\circ C$ )

Parameter	Symbol	Test Conditions	Min	Typ	Max	Units
Reverse Standoff Voltage	$V_{RWM}$	$I_R=1\mu A$ , Pin1 or Pin2 to Pin3			5	V
Breakdown Voltage	$V_{BR}$	$I_R=1mA$ , Pin1 or Pin2 to Pin3	6	7		V
Reverse Leakage Current	$I_{LEAK}$	$V_R=5V$		0.1	0.5	$\mu A$
Clamp Voltage <sup>1</sup>	$V_C$	$I_{PP}=1A$ , $t_p=8/20\mu s$ , Pin1 or Pin2 to Pin3		8.6	10	V
		$I_{PP}=5A$ , $t_p=8/20\mu s$ , Pin1 or Pin2 to Pin3		11	13.5	V
Dynamic Resistance <sup>2</sup>	$R_{DYN}$	TLP, $t_p=100ns$ , Pin1 or Pin2 to Pin3		0.24		$\Omega$
ESD Withstand Voltage <sup>1</sup>	$V_{ESD}$	IEC 61000-4-2 (Contact Discharge) Pin1 or Pin2 to Pin3	$\pm 30$			kV
		IEC 61000-4-2 (Air Discharge) Pin1 or Pin2 to Pin3	$\pm 30$			kV
Diode Capacitance <sup>1</sup>	$C_{I/O-GND}$	Reverse Bias=0V, $f=1MHz$ ; Pin1 or Pin2 to Pin3		30	40	pF

**Note:**

<sup>1</sup> Parameter is guaranteed by design and/or component characterization.

<sup>2</sup> Transmission Line Pulse (TLP) with 100ns width, 2ns rise time, and average window  $t_1=70ns$  to  $t_2=90ns$

### Capacitance vs. Reverse Bias (Pin1 or Pin2 to Pin3)

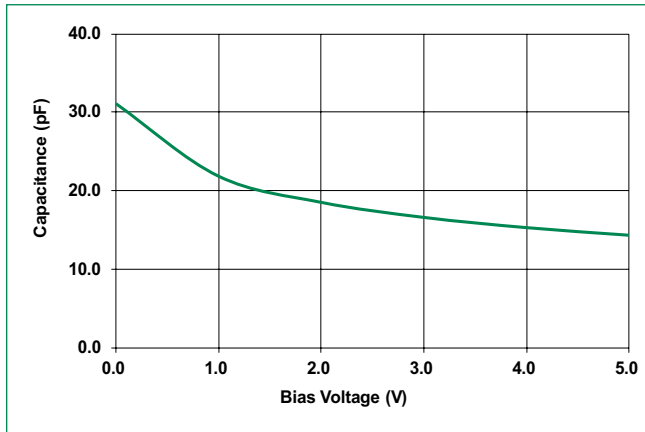

### Clamping Voltage vs. Peak Pulse Current

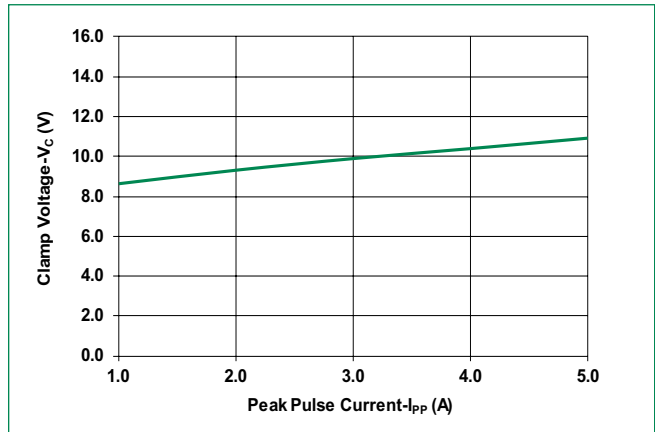

**Positive Transmission Line Pulsing (TLP) Plot**

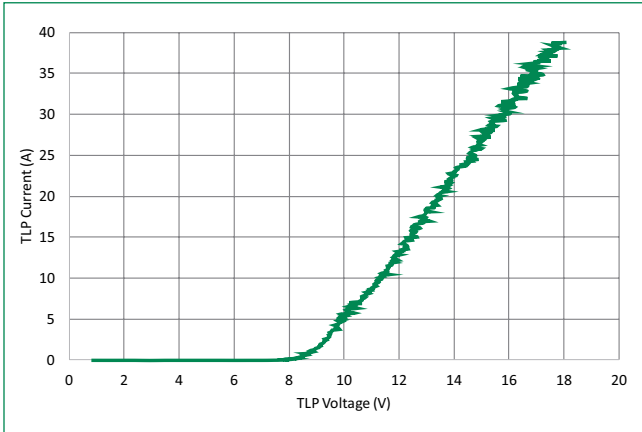

**Negative Transmission Line Pulsing (TLP) Plot**

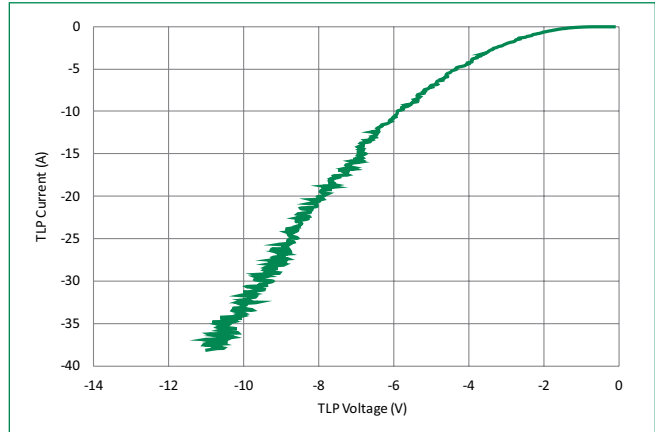

**8/20µs Pulse Waveform**

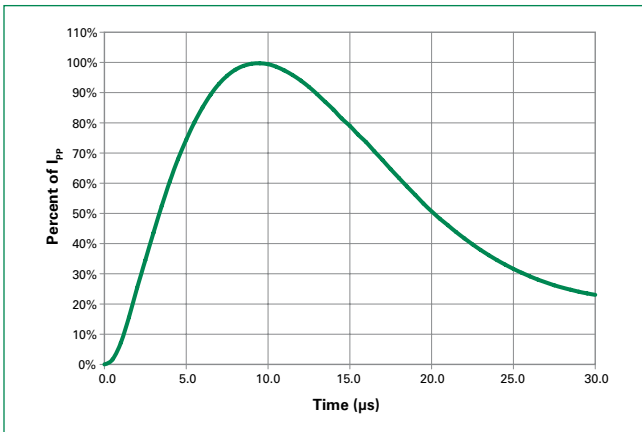

**Power Derating Curve**

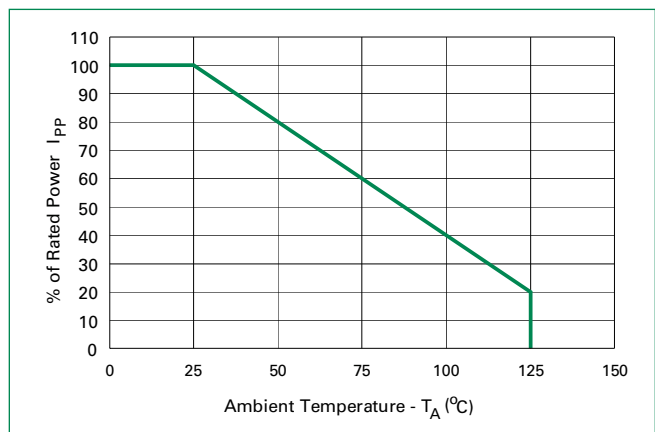

**IEC 61000-4-2 +8kV Contact ESD Clamping Voltage**

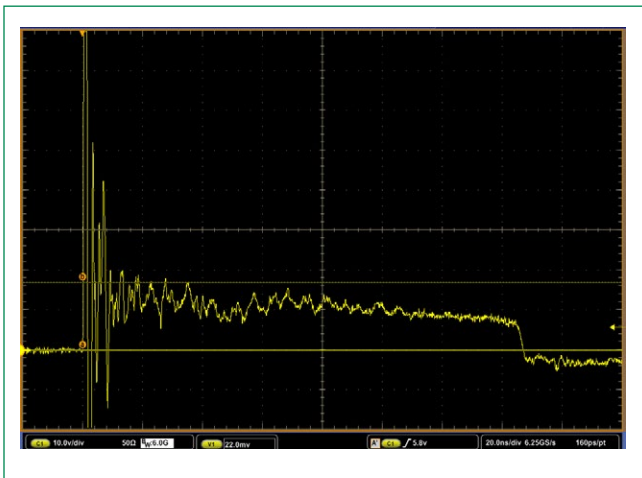

**IEC 61000-4-2 -8kV Contact ESD Clamping Voltage**

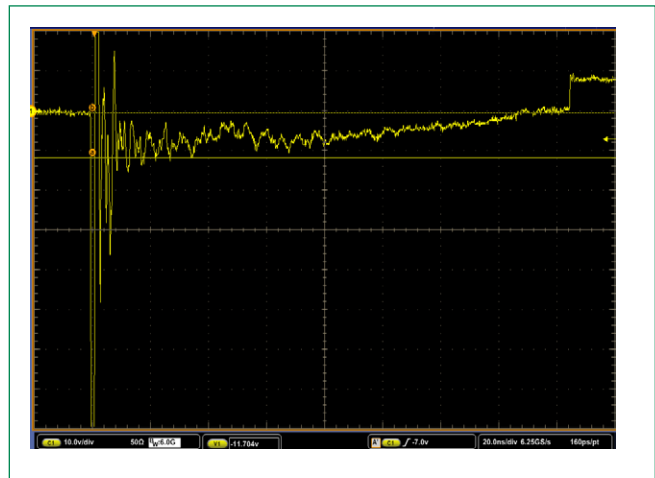

### Soldering Parameters

<b>Reflow Condition</b>		Pb – Free assembly
<b>Pre Heat</b>	- Temperature Min ( $T_{s(min)}$ )	150°C
	- Temperature Max ( $T_{s(max)}$ )	200°C
	- Time (min to max) ( $t_s$ )	60 – 180 secs
<b>Average ramp up rate (Liquidus) Temp (<math>T_L</math>) to peak</b>		3°C/second max
<b><math>T_{s(max)}</math> to <math>T_L</math> - Ramp-up Rate</b>		3°C/second max
<b>Reflow</b>	- Temperature ( $T_L$ ) (Liquidus)	217°C
	- Temperature ( $t_L$ )	60 – 150 seconds
<b>Peak Temperature (<math>T_p</math>)</b>		260 <sup>+0/-5</sup> °C
<b>Time within 5°C of actual peak Temperature (<math>t_p</math>)</b>		20 – 40 seconds
<b>Ramp-down Rate</b>		6°C/second max
<b>Time 25°C to peak Temperature (<math>T_p</math>)</b>		8 minutes Max.
<b>Do not exceed</b>		260°C

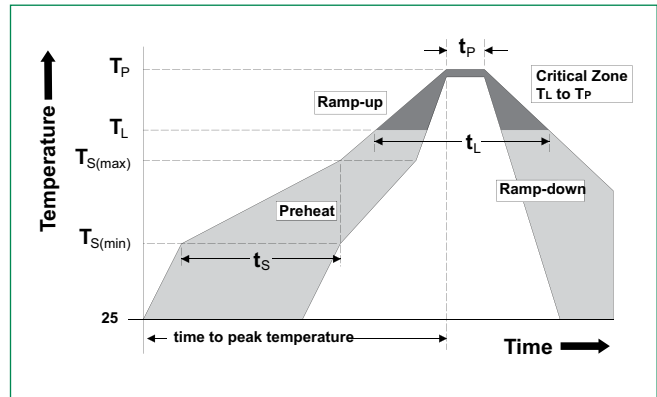

### Product Characteristics

<b>Lead Plating</b>	Matte Tin
<b>Lead Material</b>	Copper Alloy
<b>Lead Coplanarity</b>	0.004 inches(0.102mm)
<b>Substrate Material</b>	Silicon
<b>Body Material</b>	Molded Compound
<b>Flammability</b>	UL Recognized compound meeting flammability rating V-0

### Part Marking System

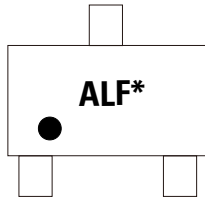

AL = Part code = SP1305-02HTG  
F = Assembly site  
\* = Date code

### Ordering Information

Part Number	Package	Min. Order Qty.
SP1305-02HTG	SOT23-3	3000

### Part Numbering System

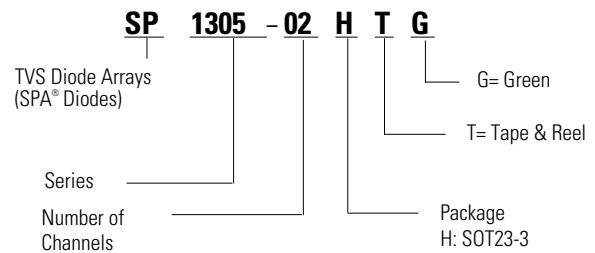

**Package Dimensions — SOT23-3**

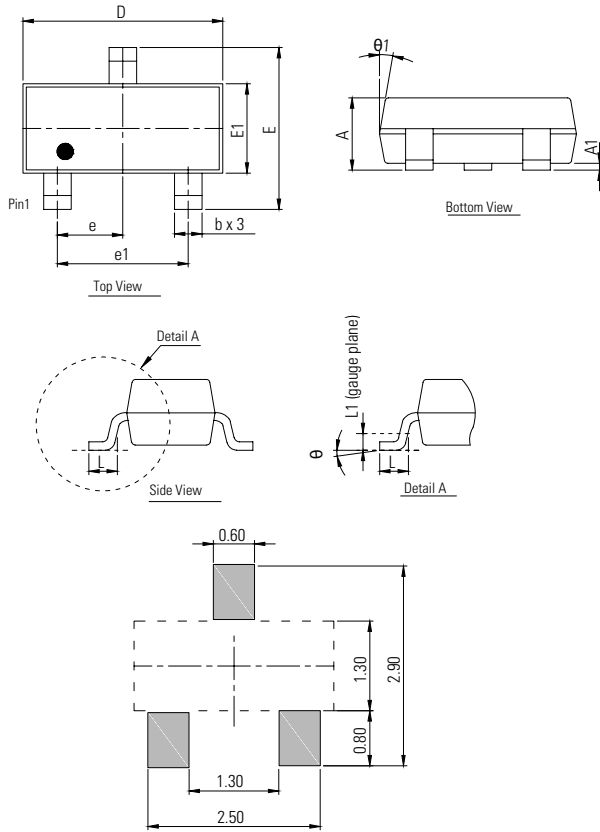

Recommended soldering pad layout (unit :mm)  
Drawing# : H01-B

Package	SOT23-3					
Pins	3					
JEDEC	TO-236					
Symbol	Millimeters			Inches		
	Min	Nom	Max	Min	Nom	Max
A	0.90	1.00	1.10	0.035	0.039	0.043
A1	0.03	-	0.09	0.001	-	0.004
b	0.37	0.44	0.51	0.015	0.017	0.020
D	2.80	2.95	3.04	0.110	0.116	0.120
E	2.10	2.40	2.64	0.083	0.094	0.104
E1	1.20	1.30	1.40	0.047	0.051	0.055
e	0.95 BSC			0.037 BSC		
e1	1.90 BSC			0.075 BSC		
L	0.30	0.45	0.55	0.012	0.018	0.022
L1	0.25 BSC			0.010 BSC		
Θ	0°	-	8°	0°	-	8°
Θ1	7°TYP			7°TYP		

**Embossed Carrier Tape & Reel Specification — SOT23-3**

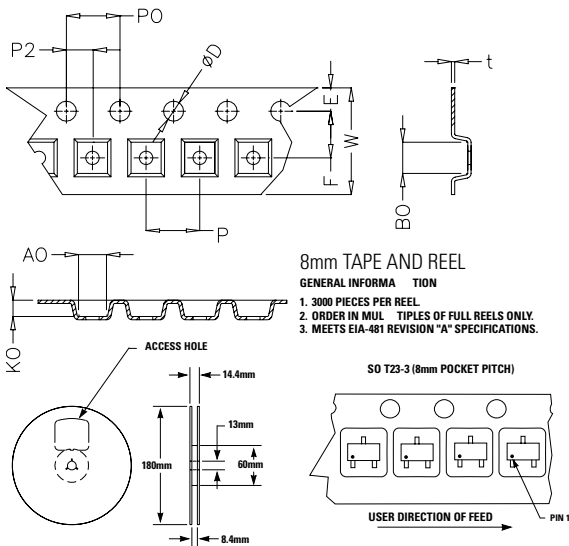

Symbol	Millimeters		Inches	
	Min	Max	Min	Max
E	1.65	1.85	0.065	0.073
F	3.40	3.60	0.134	0.142
P2	1.90	2.10	0.075	0.083
D	1.40	1.60	0.055	0.063
P0	3.90	4.10	0.154	0.161
W	7.70	8.30	0.303	0.327
P	3.90	4.10	0.154	0.161
A0	3.05	3.25	0.120	0.128
B0	2.67	2.87	0.105	0.113
K0	1.12	1.32	0.044	0.052
t	0.22	0.24	0.009	0.009