

# TSD6 SERIES

## Interval Timer

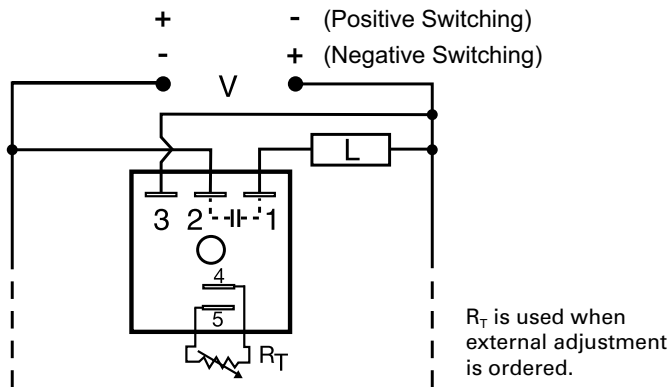

### Wiring Diagram



### Description

The TSD6 Series offers total solid-state, interval timing for 12 or 24VDC applications. This series provides either negative or positive switching. The TSD6 Series is designed for more demanding commercial and industrial applications where small size and accurate performance is required. The factory calibration for fixed time delays is within 1% of the target time delay. The repeat accuracy, under stable conditions, is 0.1% of the time delay. The TSD6 Series is rated to operate over an extended temperature range. Time delays of 0.1 seconds to 100 hours are available. The output is rated 1A steady and 10A inrush. The modules are totally solid state and encapsulated to protect the electronic circuitry.

#### Operation (Interval)





Upon application of input voltage, the time delay begins. The output energizes during the time delay. At the end of the time delay, the output de-energizes and remains de-energized until input voltage is removed.

**Reset:** Removing input voltage resets the time delay and the output.

### Features & Benefits

FEATURES	BENEFITS
<b>Microcontroller based</b>	Repeat Accuracy +/- 0.1%, +/- 1% time delay accuracy
<b>Extended temperature range</b>	Rated to 75°C operating temperature to withstand high heat applications.
<b>Compact, low cost design</b>	Allows flexibility for OEM applications
<b>1A Steady solid-state output, 10A inrush</b>	Provides 100 million operations in typical conditions.
<b>Totally solid state and encapsulated</b>	No moving parts to arc and wear out over time and encapsulated to protect against shock, vibration, and humidity

### Accessories

- 
**P1004-95, P1004-95-X Versa-Pot**  
 Panel mountable, industrial potentiometer recommended for remote time delay adjustment.
- 
**P1023-6 Mounting bracket**  
 The 90° orientation of mounting slots makes installation/removal of modules quick and easy.
- 
**P0700-7 Versa-Knob**  
 Designed for 0.25 in. (6.35 mm) shaft of Versa-Pot. Semi-gloss industrial black finish.
- 
**P1015-64 (AWG 14/16) Female Quick Connect**  
 These 0.25 in. (6.35 mm) female terminals are constructed with an insulator barrel to provide strain relief.

### Ordering Information

MODEL	INPUT VOLTAGE	ADJUSTMENT	TIME DELAY	SWITCHING MODE
TSD6113SP	12VDC	Fixed	3s	Positive
TSD61115SP	12VDC	Fixed	15s	Positive
TSD6113SN	12VDC	Fixed	3s	Negative
TSD6310.8SN	24VDC	Fixed	0.8s	Negative
TSD631380SP	24VDC	Fixed	380s	Positive
TSD6320P	24VDC	External	0.1 - 10s	Positive

If you don't find the part you need, call us for a custom product 800-843-8848

## TSD6 SERIES

### Accessories



**P1015-18 Quick Connect to Screw Adapter**  
Screw adapter terminal designed for use with all modules with 0.25 in. (6.35 mm) male quick connect terminals.



**C103PM (AL) DIN Rail**  
35 mm aluminum DIN rail available in a 36 in. (91.4 cm) length.



**P1023-20 DIN Rail Adapter**  
Allows module to be mounted on a 35 mm DIN type rail with two #10 screws.

### External Resistance vs. Time Delay

In Secs., Mins., or Hours

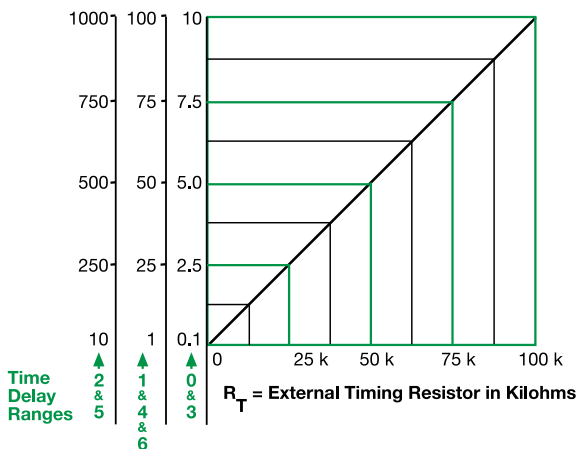

This chart applies to externally adjustable part numbers.

The time delay is adjustable over the time delay range selected by varying the resistance across the  $R_T$  terminals; as the resistance increases the time delay increases.

When selecting an external  $R_T$ , add the tolerances of the timer and the  $R_T$  for the full time range adjustment.

**Examples:** 1 to 50 S adjustable time delay, select time delay range 1 and a 50 K ohm  $R_T$ . For 1 to 100 S use a 100 K ohm  $R_T$ .

### Function Diagram

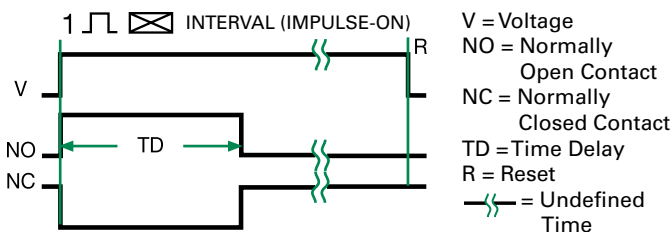

### Specifications

<b>Time Delay Range</b>	0.1s - 100h in 7 adjustable ranges or fixed
<b>Repeat Accuracy</b>	±0.1% or 20ms, whichever is greater
<b>Tolerance (Factory Calibration)</b>	≤ ±1%
<b>Reset Time</b>	≤ 150ms
<b>Time Delay vs. Temperature &amp; Voltage</b>	≤ ±1%
<b>Input Voltage</b>	12 or 24VDC
<b>Tolerance</b>	±15%
<b>DC Ripple</b>	±10%
<b>Power Consumption</b>	≤ 1W
<b>Output Type</b>	Solid state, positive or negative switching
<b>Form</b>	NO, closed during timing
<b>Maximum Load Current</b>	1A steady state, 10A inrush at 60°C
<b>Off State Leakage Current</b>	≅ 1mA
<b>Voltage Drop</b>	≅ 1.0V @ 1A
<b>Protection</b>	
<b>Circuitry</b>	Encapsulated
<b>Dielectric Breakdown</b>	≥ 2000V RMS terminals to mounting surface
<b>Insulation Resistance</b>	≥ 100 MΩ
<b>Polarity</b>	Units are reverse polarity protected
<b>Mechanical Mounting</b>	Surface mount with one #10 (M5 x 0.8) screw
<b>Dimensions</b>	<b>H</b> 50.8 mm (2"); <b>W</b> 50.8 mm (2"); <b>D</b> 30.7 mm (1.21")
<b>Termination</b>	0.25 in. (6.35 mm) male quick connect terminals
<b>Environmental</b>	
<b>Operating/Storage Temperature</b>	-40° to 75°C / -40° to 85°C
<b>Humidity</b>	95% relative, non-condensing
<b>Weight</b>	≅ 2.4 oz (68 g)