

## Isolated **miniature power BLOCK** (miniBLOC™) solution for Plasma Power Supplies

Littelfuse's isolated miniBLOC™ (SOT-227B) is a discrete miniature power BLOCK, conveniently bridging the power gap between inexpensive discrete packages and full-sized power modules. Littelfuse offers a wide range of Si and SiC miniBLOC™ MOSFET solutions catering to the design demands of plasma power supplies.

The miniBLOC™ solution offering fully isolated base plate, higher power densities, faster switching speeds, wide device choice, ease of application, and long-term reliability will serve as a key enabler, providing the right solution to development needs at different power levels.

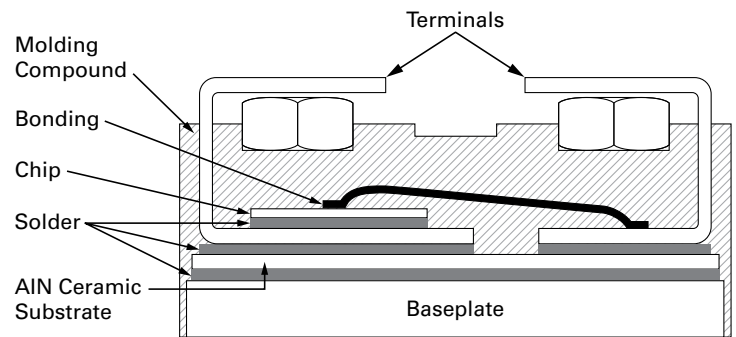

Cross-section of SOT-227B (miniBLOC)

### The **miniature power BLOCK** Advantage

#### Features

- Aluminum Nitride ceramic-based compact discrete package with electrically isolated baseplate
- Reduced overall junction-sink thermal impedance in comparison to non-isolated discretes
- Isolation up to 2.5 kV  $V_{RMS}/60$  s or 3 kV  $V_{RMS}/1$  s
- Extended creepage and clearance distances:
  - Terminal-terminal: clearance of up to 7 mm and creepage of up to 10.5 mm
  - Terminal-baseplate: clearance of up to 8.5 mm and creepage of up to 10.5 mm
- Discrete power block with high current-handling capability
- Low internal lead inductance < 5 nH
- Option for Kelvin-Source terminal
- Screw-mounted discrete package with four screwed terminal leads

#### Advantages

- Aluminum Nitride internal isolation increases power density, simplifies thermal design, improves reliability, and enables superior power cycling capability with cooler chip temperatures compared to non-isolated and conventionally isolated discretes
- Optimal for high-voltage design given the inherent isolation and extended creepage and clearance
- Reduced paralleling effort and decreased part count resulting in PCB space savings
- Higher safety overvoltage margin with reduced overvoltage stress at chip level due to lower package stray inductance
- Kelvin-Source terminal improves controllability, enabling faster switching speeds
- Rugged and stable mounting, ease of manufacturing and handling in assembly



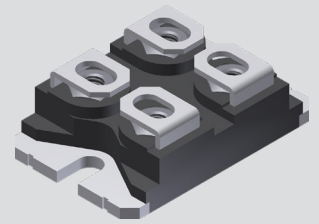
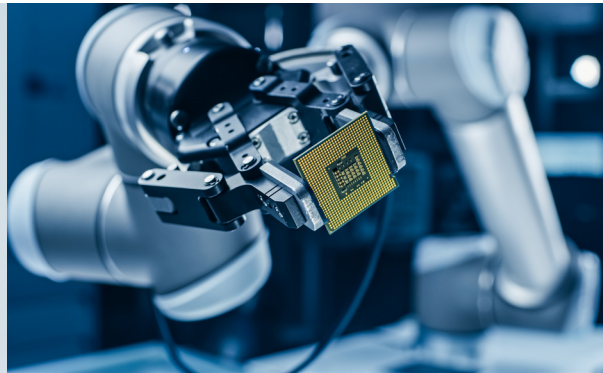
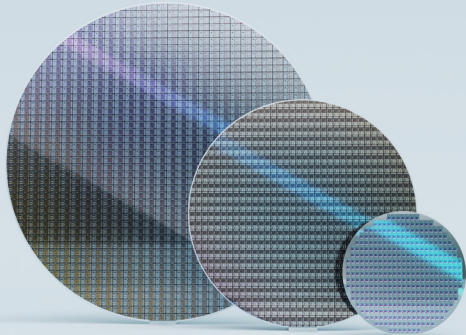

## High Current (> 50 A), 650 V Ultra Junction X2-Class MOSFETs in miniBLOC™

$R_{DS(on),max}$ [mΩ]	$I_{D25}$ [A]	miniBLOC™ 
13	170	IXFN170N65X2 ●
17	145	IXFN150N65X2 ●
24	108	IXFN120N65X2 ●
30	78	IXFN100N65X2 ●
30	76	IXTN102N65X2 ●

- HiPerFET™ (fast-body diode)
- Standard body diode

The 650 V X2-Class Ultra Junction MOSFETs in miniBLOC™ package from Littelfuse exhibit some of the highest current ratings, lowest on-state resistances  $R_{DS(on)}$ , low gate charge  $Q_g$ , and superior  $dv/dt$  performance. Their superior avalanche capability further enhances device ruggedness in critical applications. Additionally, the HiPerFET™ devices with fast soft-recovery body diode have reduced switching losses and a better electromagnetic interference (EMI) behavior.

These benefits of the 650 V Ultra Junction X2-Class MOSFETs in combination with the advantages offered by the miniBLOC™ package make them a preferred choice for plasma power supplies.

AC Input: 3-Ph, 170 - 480 V, 50/60 Hz; DC Output: 600 - 800 V

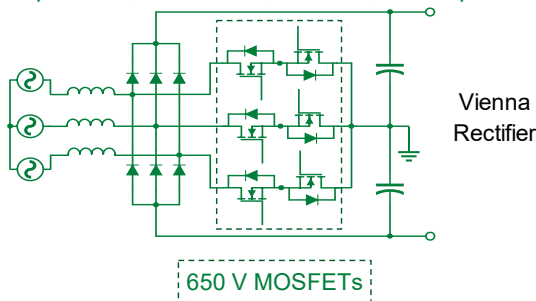

AC Input: 1-Ph, 85 - 265 V, 50/60 Hz; DC Output: < 400 V

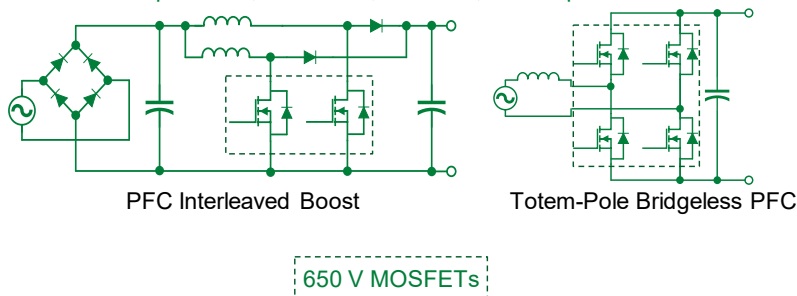

Scan this QR code to access the Littelfuse webpage on Ultra Junction X2-Class MOSFETs



# Littelfuse®

Expertise Applied | Answers Delivered

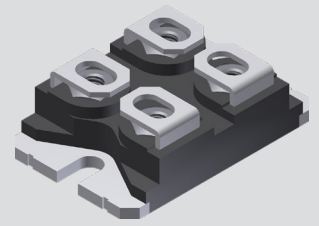
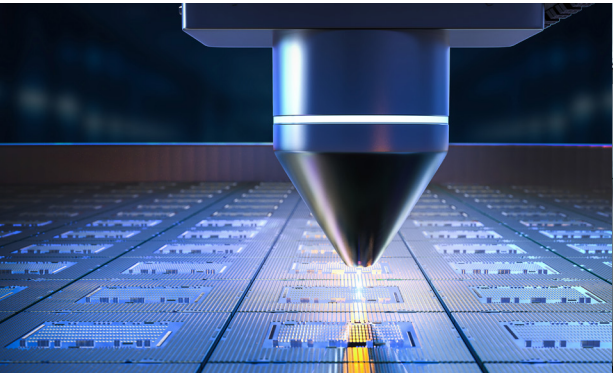

## 900–1200 V Polar™ HiPerFET™ in miniBLOC™

$R_{DS(on),max}$ [Ω]	$I_{D25}$ [A]	$V_{DSS}$ [V]	miniBLOC™ 
0.145	56	900	IXFN56N90P
0.160	43	900	IXFN52N90P
0.230	33	900	IXFN40N90P
0.21	38	1000	IXFN38N100P
0.22	37	1000	IXFN44N100P
0.32	27	1000	IXFN32N100P
0.39	23	1000	IXFN26N100P
0.26	34	1100	IXFN40N110P
0.31	32	1200	IXFN32N120P
0.35	30	1200	IXFN30N120P
0.46	23	1200	IXFN26N120P
0.57	20	1200	IXFN20N120P

Littelfuse 900–1200 V Polar™ HiPerFET™ devices are tailored to provide designers with a rugged device solution that offers the best advantage in performance and cost in high frequency applications.

These devices incorporate the Polar technology platform to achieve low on-state resistances  $R_{DS(on)}$  which improves conduction behavior. The low gate charge  $Q_g$  and fast body diode results in more efficient switching at all frequencies. The dv/dt and avalanche capabilities of these devices provide additional safeguards against overvoltage transients.

The benefits of the Polar™ HiPerFET™ devices, in addition to the advantages offered by the miniBLOC™ package, make them the best solution for plasma power supplies.

### DC/DC LLC Converter

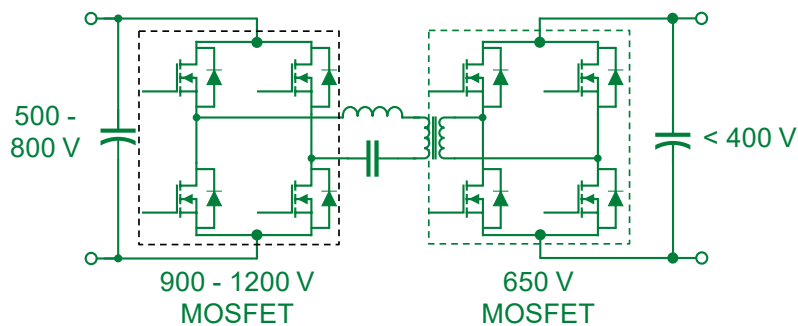

Scan this QR code to access the Littelfuse webpage on Polar HiPerFET™ devices



# Littelfuse®

Expertise Applied | Answers Delivered





**Littelfuse**<sup>®</sup>

Expertise Applied | Answers Delivered

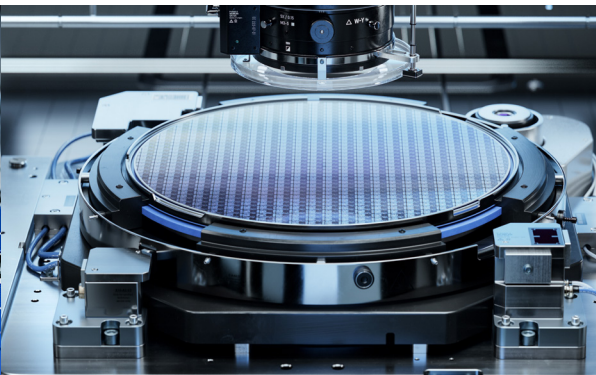

## 1200 V SiC MOSFETs in miniBLOC™ with Kelvin-Source

$R_{DS(on),max}$ [mΩ]	$I_{D25}$ [A]	$V_{DSS}$ [V]	miniBLOC™ w/ Kelvin-Source 
10	130	900	IXFN130N90SK
21	75	1200	IXFN75N120SK
32	55	1200	IXFN55N120SK
75	30	1200	IXFN30N120SK

Note: Preliminary datasheet and engineering samples available for the SiC MOSFETs in the table above

Littelfuse 1200 V SiC MOSFETs featuring low  $R_{DS(on)}$  and low device capacitances, offer the highest efficiency for reduced cooling effort. The excellent conduction and switching behavior combined with higher frequency operation improves power density in the application.

The SiC MOSFETs in miniBLOC™ featuring a Kelvin-Source connection offer superior immunity to parasitic turn-on/turn-off events, thereby maximizing the high-speed switching performance of the MOSFET.

These advantages of SiC MOSFETs combined with the benefits offered by the miniBLOC™ package make them a preferred choice in Plasma Power Supplies.

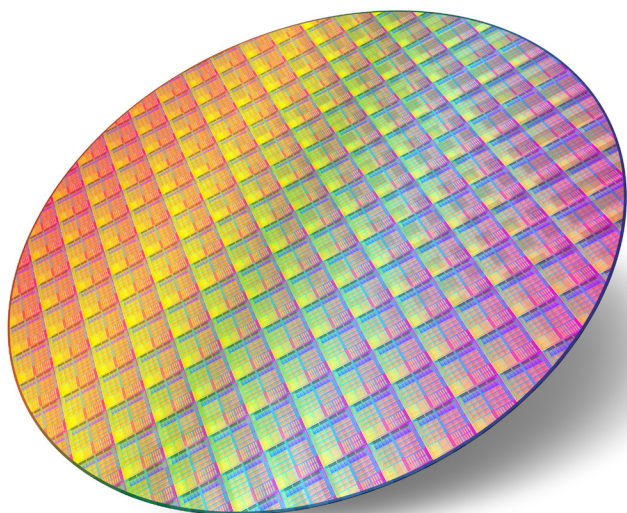

Scan this QR code to access the Littelfuse webpage on SiC MOSFETs



**Littelfuse**<sup>®</sup>

Expertise Applied | Answers Delivered