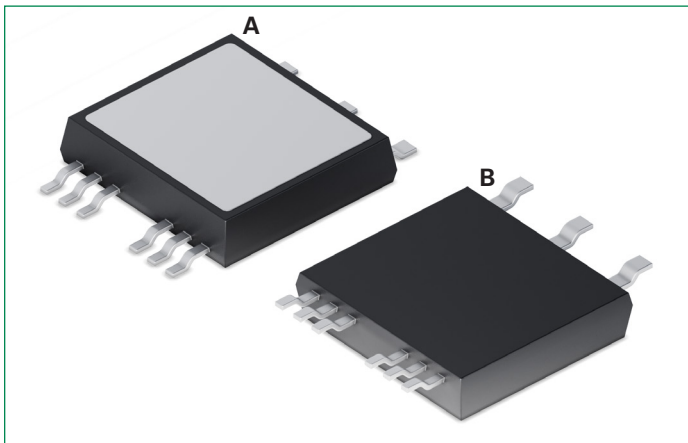

MCL10P1200LB

1200 V, 160 mΩ, 19.5 A SiC Power MOSFET in Phase-Leg Configuration

E72873 Pending

**A:** Top, **B:** Bottom

Pinout Diagram (SMPD-B)

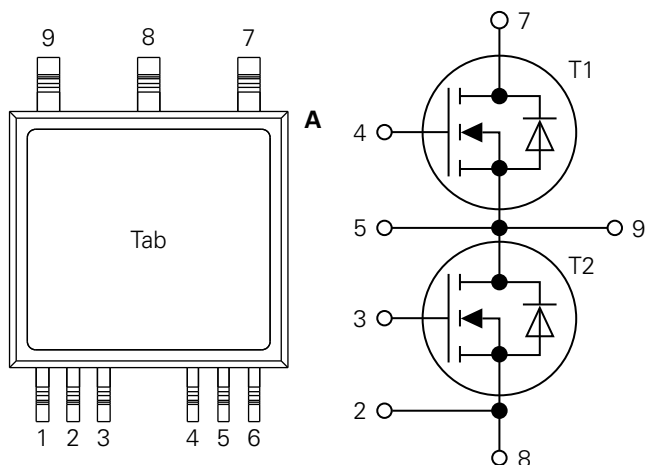

1: Not Connected; **2:** Kelvin Source T2; **3:** Gate T2; **4:** Gate T1;
5: Kelvin Source T1; **6:** Not Connected; **7:** DC+; **8:** DC-; **9:** Output;

Tab: Electrically Isolated

Features & Benefits:

- High speed switching with low capacitances
- High blocking voltage with low $R_{DS(on)}$
- Easy to parallel and simple to drive
- Resistant to latch-up

SMPD Package:

- DCB based isolated package improves thermal resistance and power handling capability
- Isolation voltage 2500V AC (RMS), 1 minute
- Low drain-to-tab stray capacitance
- Optimized package with separate driver source pin
- Advanced topside cooled packaging simplifies thermal management
- RoHS compliant
- Epoxy meets UL 94V-0

Applications:

- Solar Inverters
- High Voltage DC/DC converters
- Motor Drives
- Switch Mode Power Supplies
- UPS
- Battery Chargers
- Induction Heating

Product Summary

Characteristic	Value	Unit
I_{D25}	19.5	A
V_{DSS}	1200	V
$R_{DS(on)typ}$	160	mΩ

MOSFET Characteristics

Symbol	Characteristics	Conditions	Ratings			Unit		
			Min.	Typ.	Max.			
BV_{DSS}	Drain-Source Breakdown Voltage	$I_D = 100 \mu A$	1200	-	-	V		
I_{D25}	Drain Current	$V_{GS} = 20 V$	$T_C = 25^\circ C$	-	-	19.5	A	
I_{D80}			$T_C = 80^\circ C$	-	-	15		
I_{D100}			$T_C = 100^\circ C$	-	-	13.5		
V_{GS}	Gate-Source Voltage	Continuous	$T_{VJ} = 25^\circ C$	-30	-	30	V	
		Transient		-5	-	+20		
$V_{GS(th)}$	Gate Threshold Voltage	$I_D = 5 mA, V_{GS} = V_{DS}$	$T_{VJ} = 25^\circ C$	1.8	2.8	4.0	V	
			$T_{VJ} = 175^\circ C$	-	1.8	-		
$T_{VJ,op}$	Virtual Junction Temperature	-	-55	-	150	$^\circ C$		
I_{DSS}	Drain-Source Leakage Current	$V_{DS} = 1200 V, V_{GS} = 0 V$	$T_{VJ} = 25^\circ C$	-	1	100	μA	
			$T_{VJ} = 175^\circ C$	-	1	-		
I_{GSS}	Gate-Source Leakage Current	$V_{DS} = 0 V, V_{GS} = 22 V$	$T_{VJ} = 25^\circ C$	-	-	100	nA	
		$V_{GS} = -6 V$	$T_{VJ} = 25^\circ C$	-	-	100		
$R_{DS(on)}$	Drain-Source On-State Resistance	$I_D = 10 A, V_{GS} = 20 V$	$T_{VJ} = 25^\circ C$	-	160	200	m Ω	
			$T_{VJ} = 175^\circ C$	-	230	-		
$R_{G(int)}$	Internal Gate Resistance	$f = 1 MHz, V_{AC} = 25 mV, ESR \text{ of } C_{iss}$			-	0.85	-	Ω
C_{iss}	Input Capacitance	$V_{DS} = 800 V, V_{GS} = 0 V,$ $f = 1 MHz$	$T_{VJ} = 25^\circ C$	-	890	-	pF	
C_{oss}	Output Capacitance			-	45	-		
C_{rss}	Reverse Transfer (Miller) Capacitance			-	5	-		
E_{oss}	C_{OSS} stored energy			-	14	-		μJ
Q_g	Total Gate Charge	$V_{DS} = 800 V, I_D = 10 A,$ $V_{GS} = -5/20 V$	$T_{VJ} = 25^\circ C$	-	50	-	nC	
Q_{gs}	Gate Source Charge			-	15	-		
Q_{gd}	Gate Drain (Miller) Charge			-	17	-		
$t_{d(on)}$	Turn-on Delay Time	Inductive Switching Free Wheeling Diode: Body Diode $V_{GS} = -5 V,$ $V_{DS} = 800 V, I_D = 10 A$ $V_{GS} = -5/20 V, R_{G(ext)} = 18 \Omega$	$T_{VJ} = 25^\circ C$	-	9.4	-	ns	
			$T_{VJ} = 150^\circ C$	-	8.7	-		
t_r	Current Rise Time		$T_{VJ} = 25^\circ C$	-	4	-	ns	
			$T_{VJ} = 150^\circ C$	-	3.1	-		
$t_{d(off)}$	Turn-off Delay Time		$T_{VJ} = 25^\circ C$	-	24.5	-	ns	
			$T_{VJ} = 150^\circ C$	-	30.2	-		
t_f	Current Fall Time		$T_{VJ} = 25^\circ C$	-	31	-	ns	
			$T_{VJ} = 150^\circ C$	-	31.8	-		
E_{on}	Turn-on Energy per Pulse		$T_{VJ} = 25^\circ C$	-	310	-	μJ	
			$T_{VJ} = 150^\circ C$	-	405	-		
E_{off}	Turn-off Energy per Pulse	$T_{VJ} = 25^\circ C$	-	19.7	-	μJ		
		$T_{VJ} = 150^\circ C$	-	22.7	-			
$R_{th,JC}$	Thermal Resistance, junction-to-case	-	-	-	1.4	K/W		
$R_{th,JS}$	Thermal Resistance, junction-to-sink	per MOSFET with heatsink compound $\lambda = 0.67 W/mK$			-	2.2	-	K/W

Source-Drain Diode of MOSFET Characteristics

Symbol	Characteristics	Conditions	Ratings			Unit	
			Min.	Typ.	Max.		
V_{SD}	Forward Voltage Drop	$I_F = 5 \text{ A}$, $V_{GS} = -5 \text{ V}$	$T_{VJ} = 25^\circ\text{C}$	-	4.2	-	V
			$T_{VJ} = 175^\circ\text{C}$	-	3.7	-	
t_{rr}	Reverse Recovery Time	$V_{GS} = -5 \text{ V}$, $I_F = 10 \text{ A}$, $V_R = 800 \text{ V}$, MOSFET gate drive: $V_{GS} = -5/20 \text{ V}$, $R_G = 18 \Omega$ (external)	$T_{VJ} = 25^\circ\text{C}$	-	11.9	-	ns
			$T_{VJ} = 150^\circ\text{C}$	-	18.2	-	
Q_{rr}	Reverse Recovery Charge		$T_{VJ} = 25^\circ\text{C}$	-	182	-	nC
			$T_{VJ} = 150^\circ\text{C}$	-	334	-	
I_{rr}	Max. Reverse Recovery Current		$T_{VJ} = 25^\circ\text{C}$	-	14.7	-	A
			$T_{VJ} = 150^\circ\text{C}$	-	20.5	-	
dl_F/dt	Current Slew Rate		$T_{VJ} = 25^\circ\text{C}$	-	2320	-	A/ μs
			$T_{VJ} = 150^\circ\text{C}$	-	2840	-	
$E_{rec(off)}$	Turn-off Energy of Intrinsic Diode per Pulse		$T_{VJ} = 25^\circ\text{C}$	-	50.6	-	μJ
			$T_{VJ} = 150^\circ\text{C}$	-	69.0	-	

SMPD Package

Symbol	Characteristics	Conditions	Value			Unit	
			Min.	Typ.	Max.		
I_{RMS}	RMS Current	Wide Terminal	-	-	100	A	
		Standard Terminal	-	-	60		
T_{stg}	Storage Temperature	-	-55	-	150	$^\circ\text{C}$	
T_{op}	Operation Temperature	-	-55	-	150		
F_C	Mounting Force with Clip	-	40	-	130	N	
$d_{Spp/App}$ $d_{Spb/Apb}$	Creepage Distance on Surface / Clearance Distance Through Air	Terminal to Terminal	Between Pin 1 to 3	1.6	-	-	mm
			Between Pin 4 to 6				
		Terminal to Backside Plane	Between Pin 3 to 4	6.8	-	-	mm
			Between Pin 7 to 9				
	Clearance Distance Through Air	Terminal to Backside Plane	For All Terminals	4	-	-	mm
	Creepage Distance on Surface	Terminal to Backside Tab		5.17	-	-	mm
V_{ISOL}	Isolation Voltage	50/60 Hz; RMS; $I_{ISOL} < 1 \text{ mA}$, $t = 1 \text{ second}$		-	3000	-	V
		50/60 Hz; RMS; $I_{ISOL} < 1 \text{ mA}$, $t = 1 \text{ minute}$		-	2500	-	
W	Weight	-	-	8	-	g	

Characteristic Curves

Fig.1. Maximum Power Dissipation ($T_{VJ} = 175\text{ }^{\circ}\text{C}$)

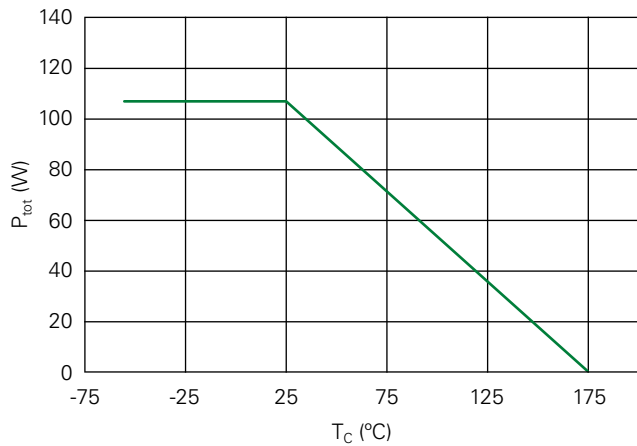

Fig. 2. Typical Transfer Characteristics

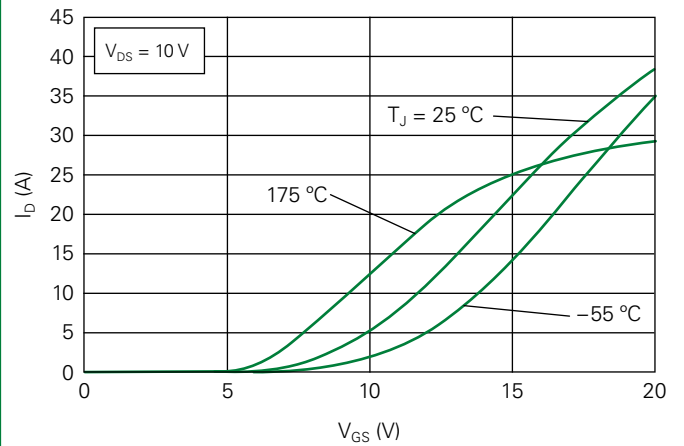

Fig. 3. Typical Output Characteristics ($T_{VJ} = 25\text{ }^{\circ}\text{C}$)

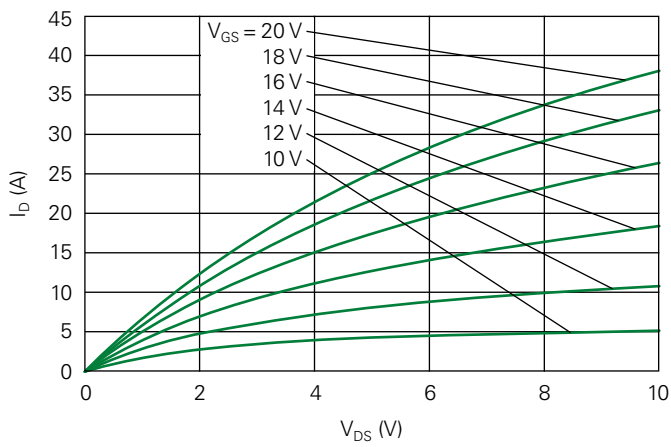

Fig. 4. Typical Output Characteristics ($T_{VJ} = 175\text{ }^{\circ}\text{C}$)

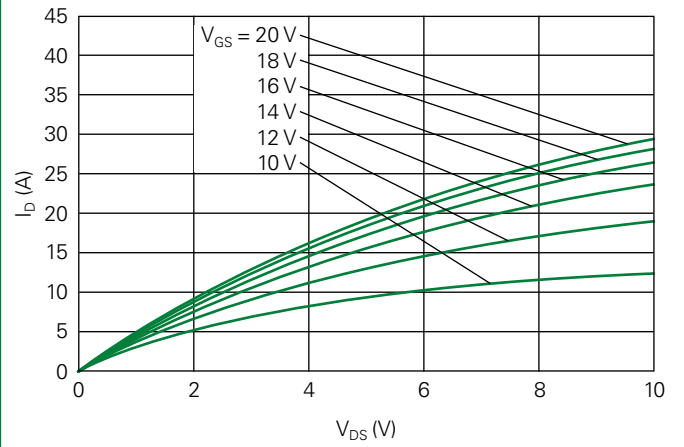

Fig. 5. Typical Output Characteristics ($T_{VJ} = -55\text{ }^{\circ}\text{C}$)

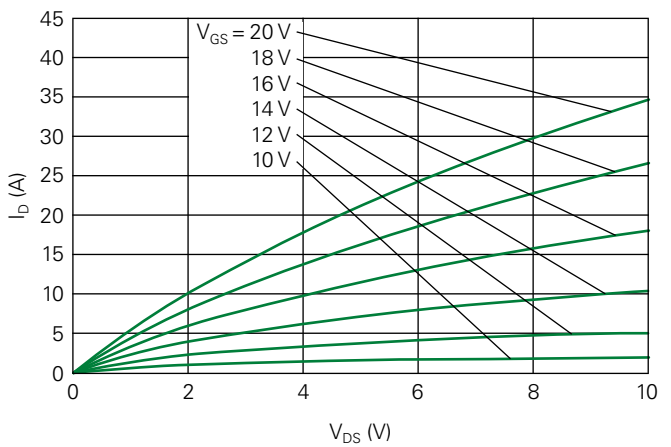
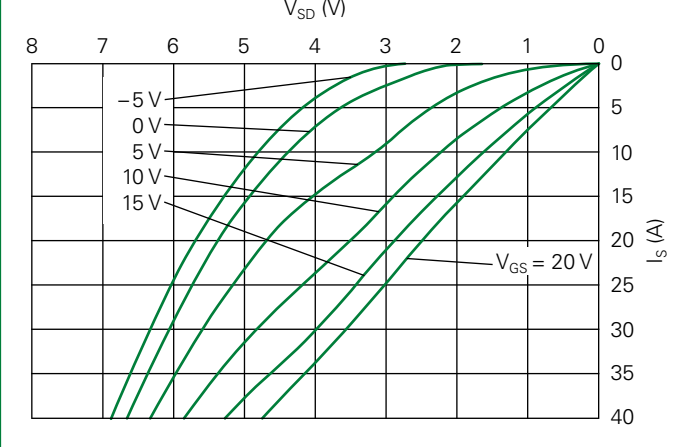

Fig. 6. Typical Reverse Conduction Characteristics ($T_{VJ} = 25\text{ }^{\circ}\text{C}$)



Characteristic Curves

Fig. 7. Typical Reverse Conduction Characteristics ($T_{vj} = 175\text{ }^\circ\text{C}$)

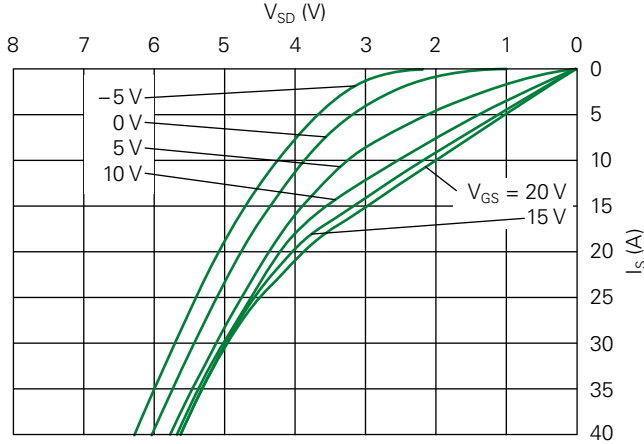

Fig. 8. Typical Reverse Conduction Characteristics ($T_{vj} = -55\text{ }^\circ\text{C}$)

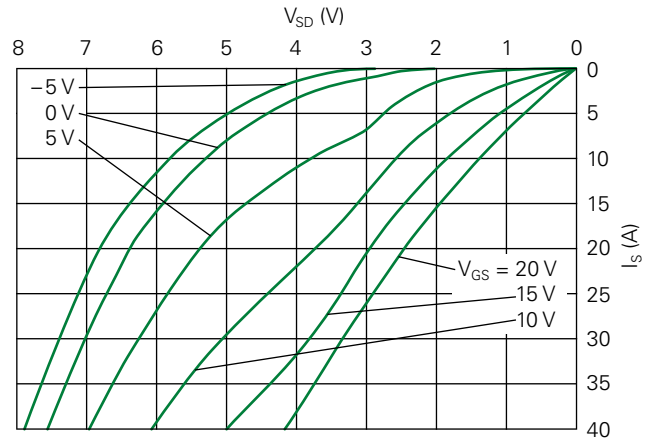

Fig. 9. Typical Transient Thermal Response Junction to Heat Sink

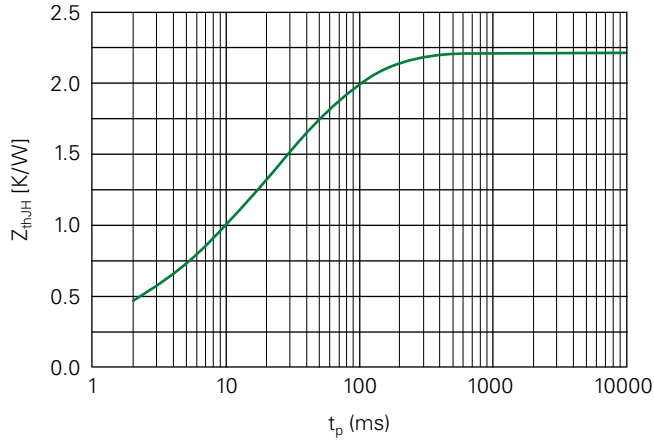

Fig. 10. Drain-Source On-State Resistance vs. Drain Current

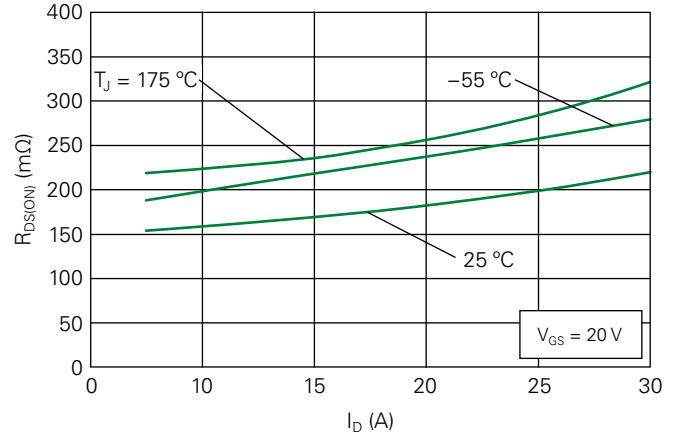

Fig. 11. Normalized On-State Resistance vs. Junction Temperature

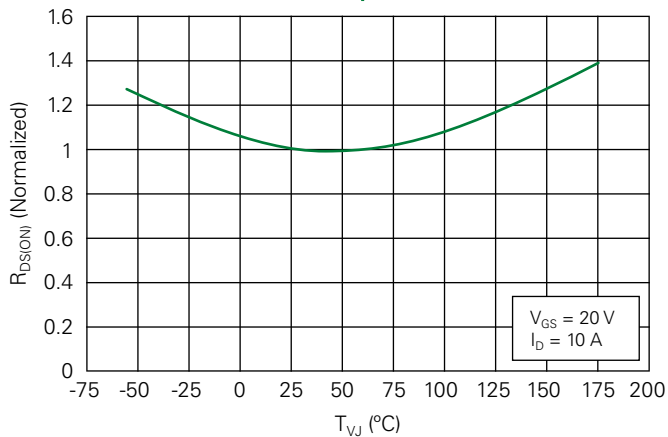

Fig. 12. Typical On-State Resistance vs. Junction Temperature

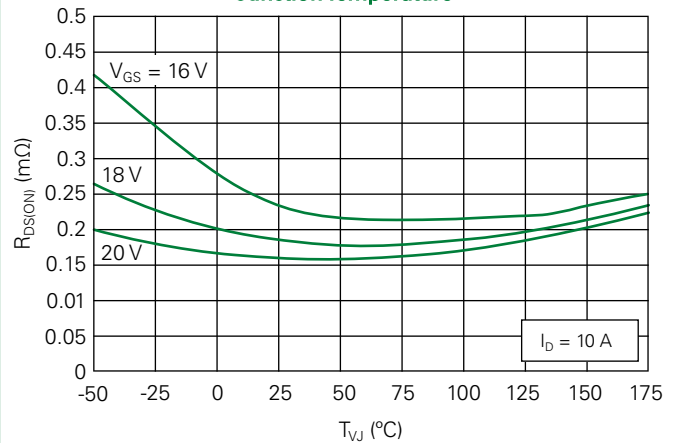

Fig. 13. Typical Threshold Voltage

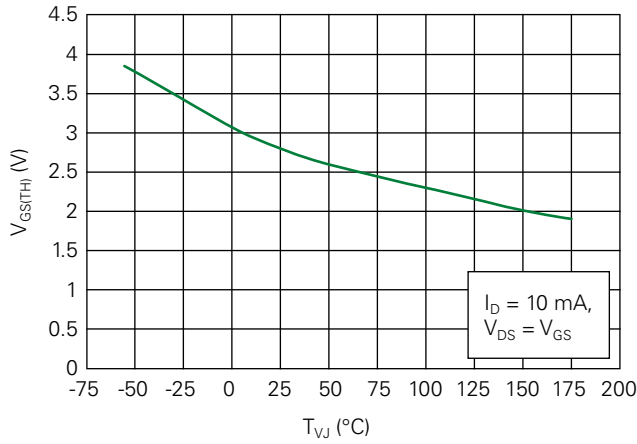

Fig. 14. Typical Junction Capacitance up to 1000V

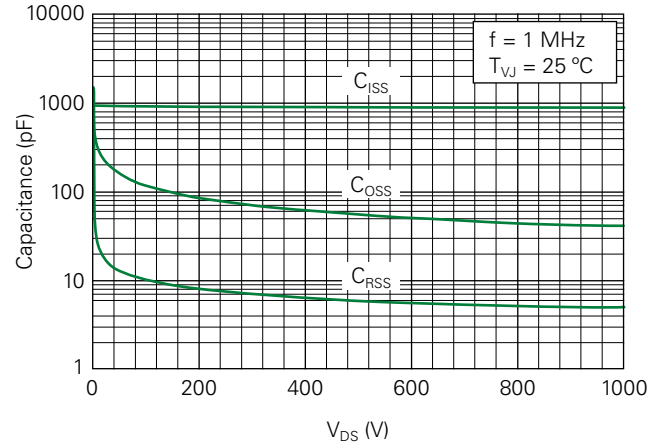

Fig. 15. Typical Junction Capacitance up to 200V

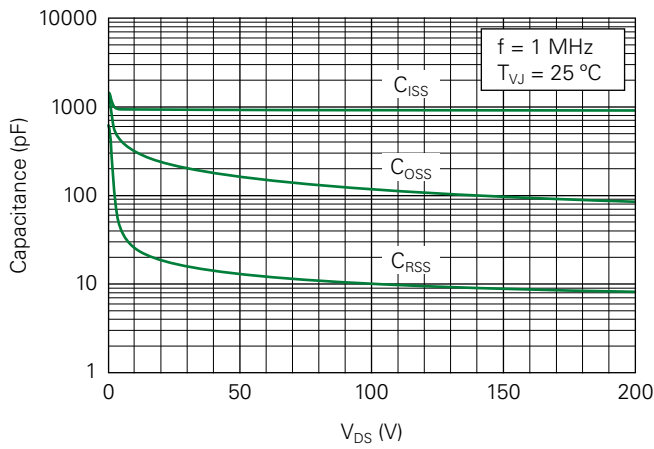

Fig. 16. Typical C_OSS Stored Energy E_OSS

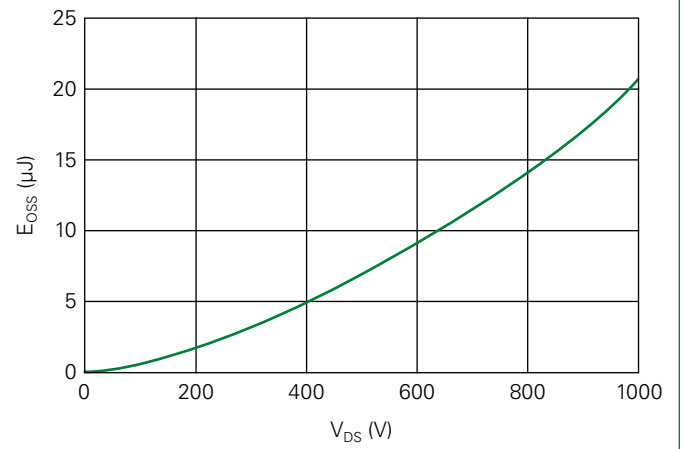

Fig. 17. Typical Switching Energy at 25 °C vs. Drain Current

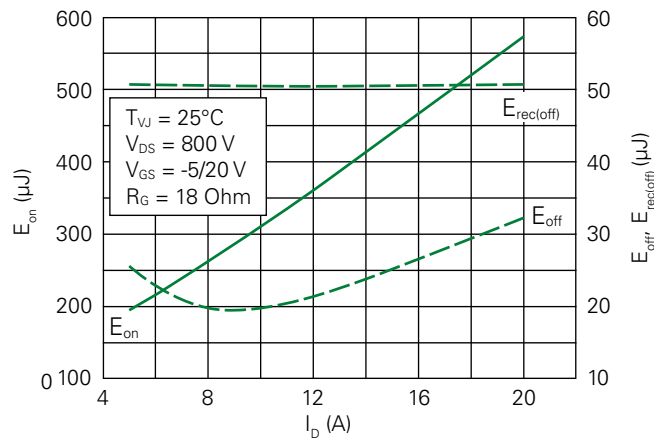

Fig. 18. Typical Switching Energy at 150 °C vs. Drain Current

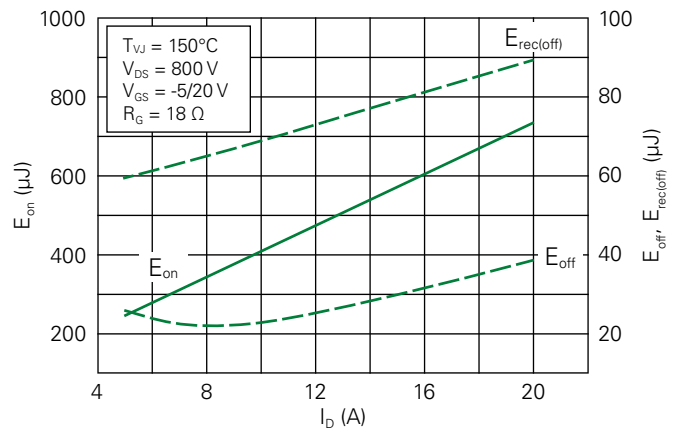

Fig. 19. Typical Switching Energy at 25 °C vs. External Gate Resistor

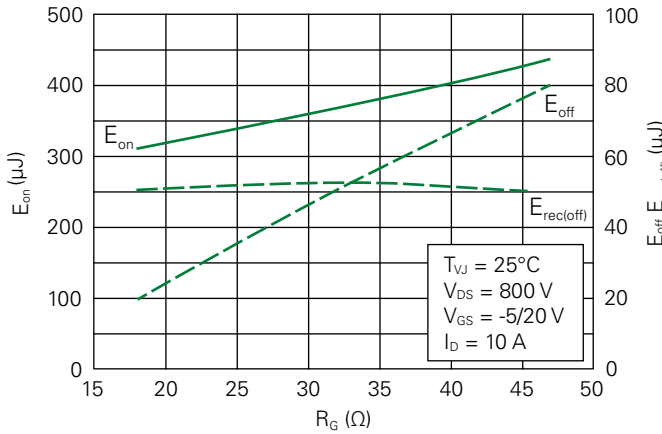

Fig. 20. Typical Switching Energy at 150 °C vs. External Gate Resistor

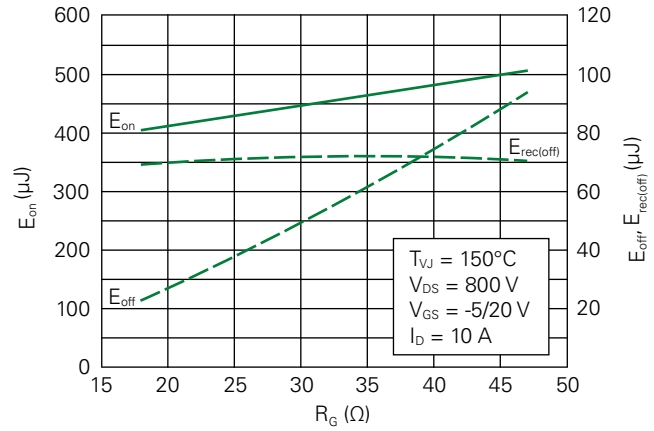

Fig. 21. Typical Switching Energy vs. Temperature

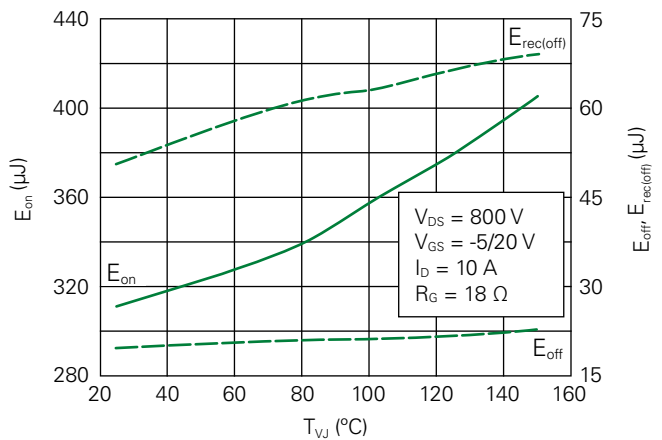

Fig. 22. Typical Switching Times at 25°C vs. Drain Current

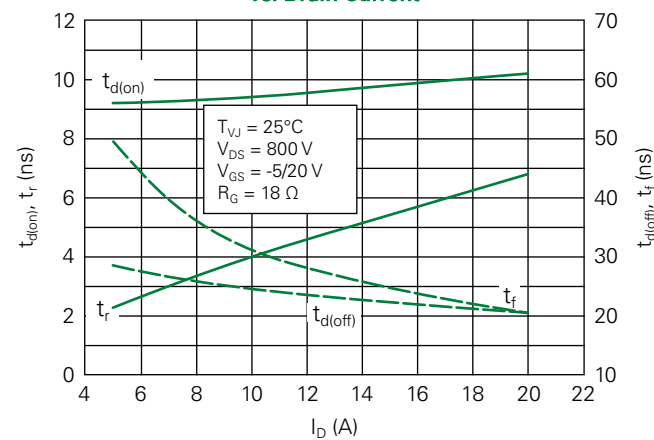

Fig. 23. Typical Switching Times at 150°C vs. Drain Current

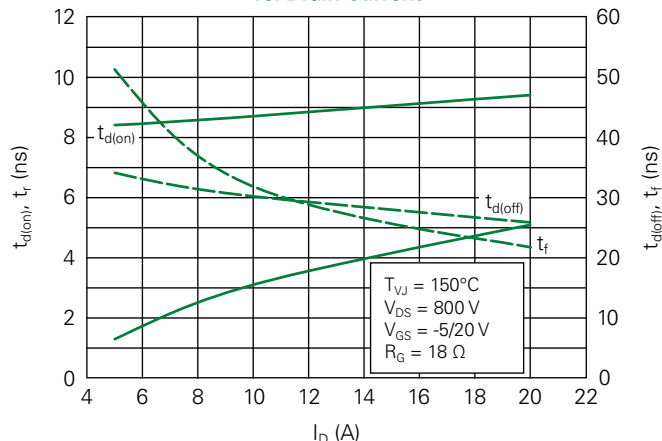

Fig. 24. Typical Switching Times at 25°C vs. External Gate Resistor

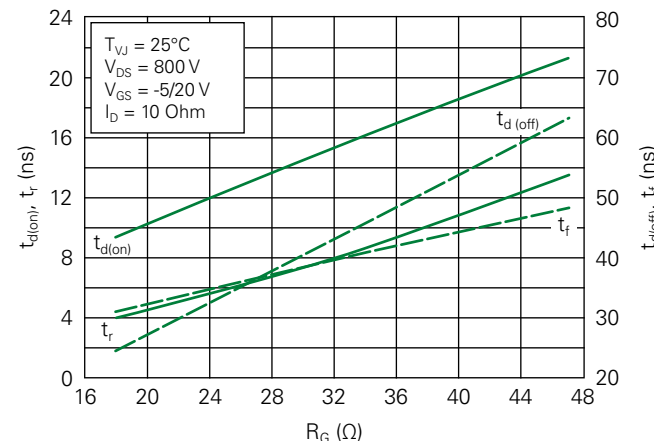

Fig. 25. Typical Switching Times at 150°C vs. External Gate Resistor

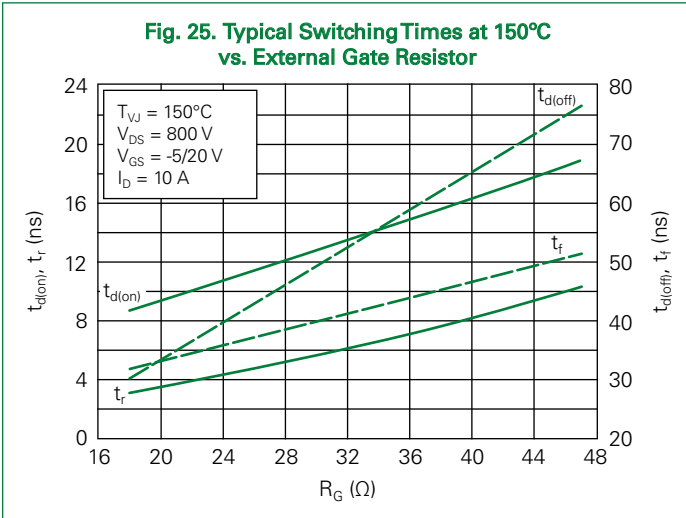

Fig. 26. Typical Switching Times vs. Temperature

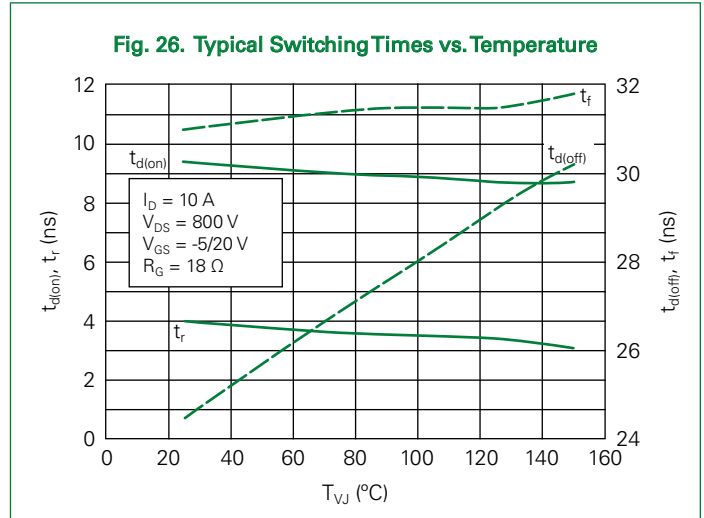

Fig. 27. Typical Reverse Recovery Characteristic of Intrinsic Diode at 25°C vs. Drain Current

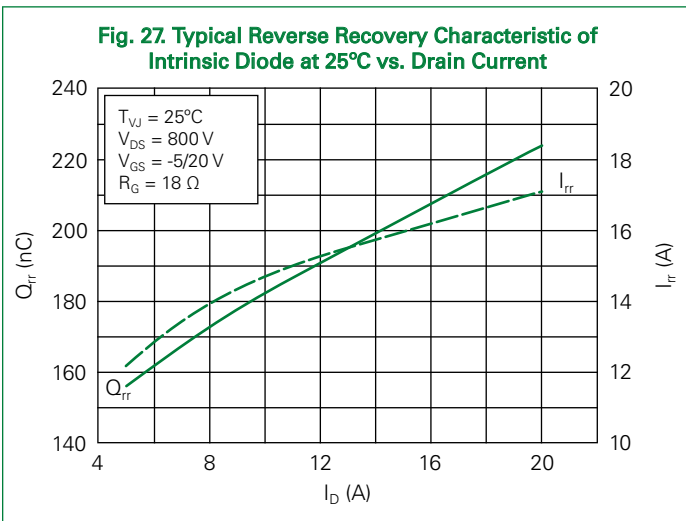

Fig. 28. Typical Reverse Recovery Characteristic of Intrinsic Diode at 150°C vs. Drain Current

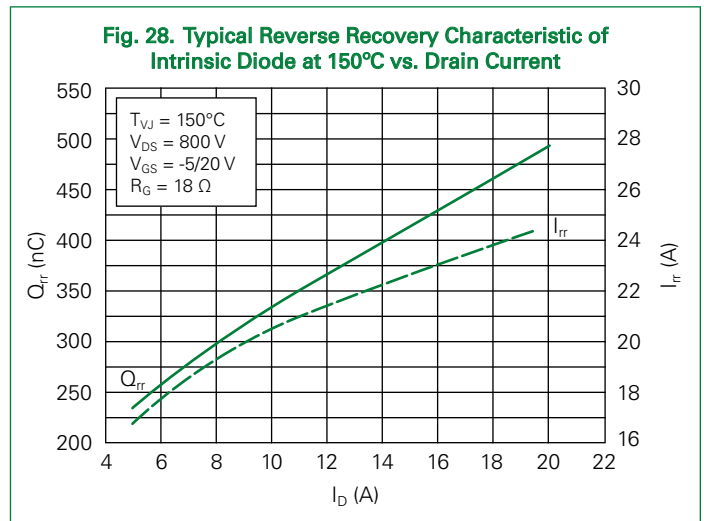

Fig. 29. Typical Reverse Recovery Characteristic of Intrinsic Diode at 25°C vs. External Gate Resistor

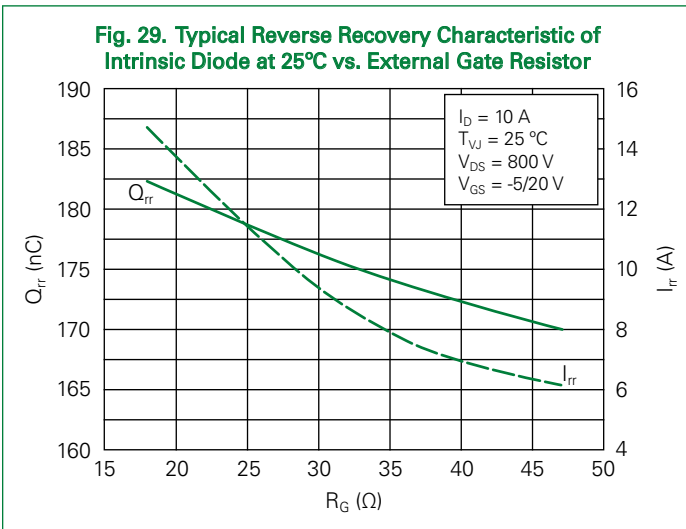

Fig. 30. Typical Reverse Recovery Characteristic of Intrinsic Diode at 150°C vs. External Gate Resistor

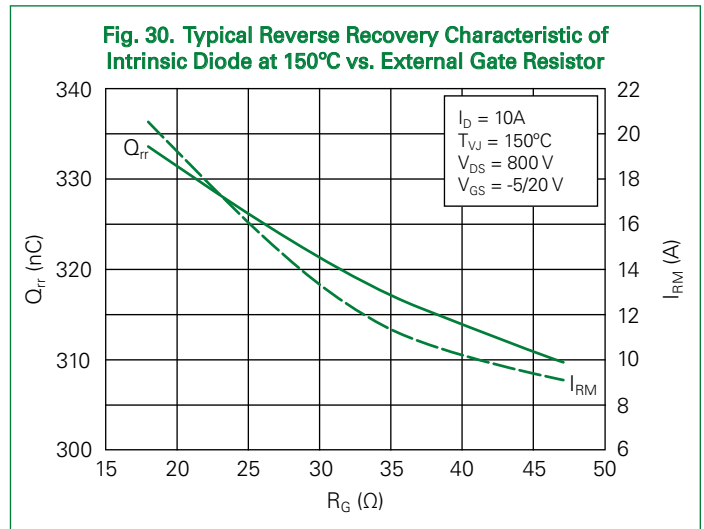

Fig. 31. Typical Reverse Recovery Characteristic of Intrinsic Diode vs. Temperature

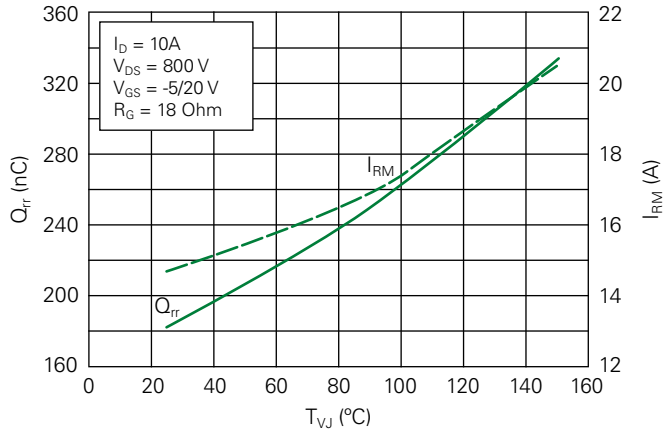

Fig. 32. Typical Reverse Recovery Characteristic of Intrinsic Diode at 25°C vs. Drain Current

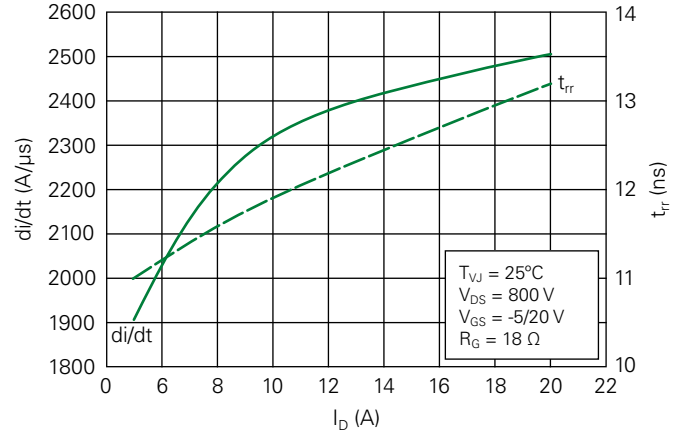

Fig. 33. Typical Reverse Recovery Characteristic of Intrinsic Diode at 150°C vs. Drain Current

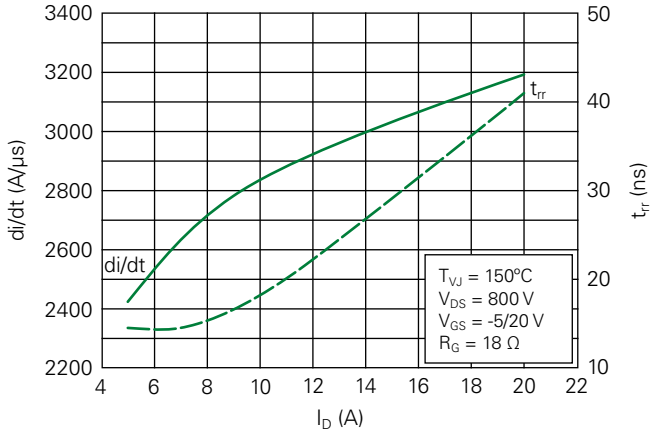

Fig. 34. Typical Reverse Recovery Characteristic of Intrinsic Diode at 25°C vs. External Gate Resistor

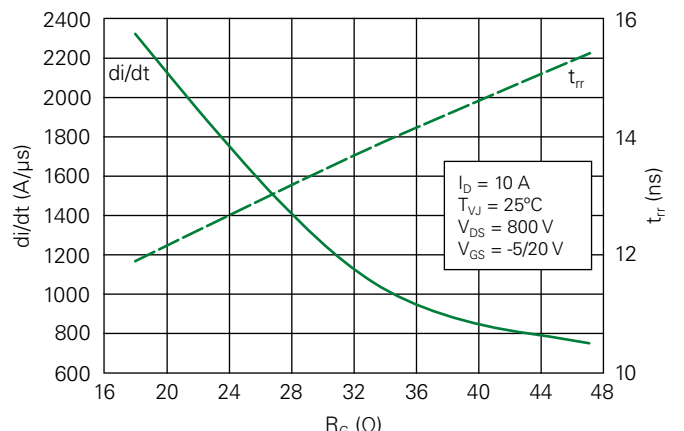

Fig. 35. Typical Reverse Recovery Characteristic of Intrinsic Diode at 150°C vs. External Gate Resistor

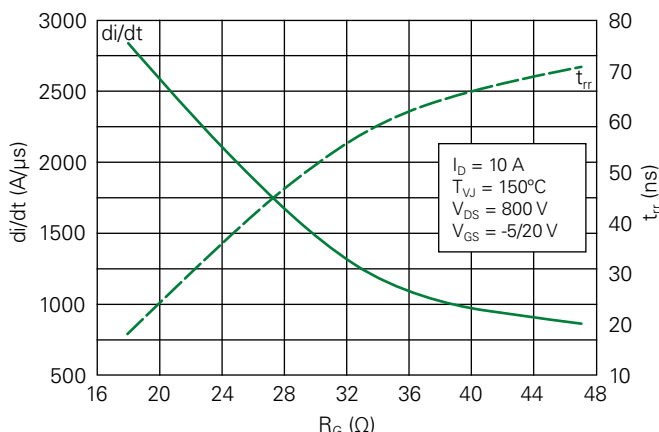
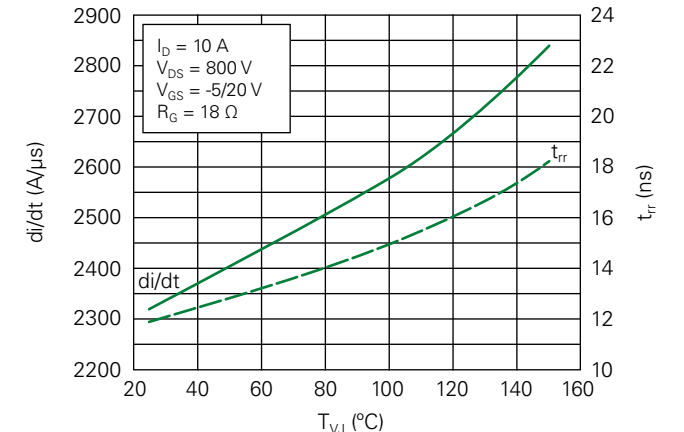
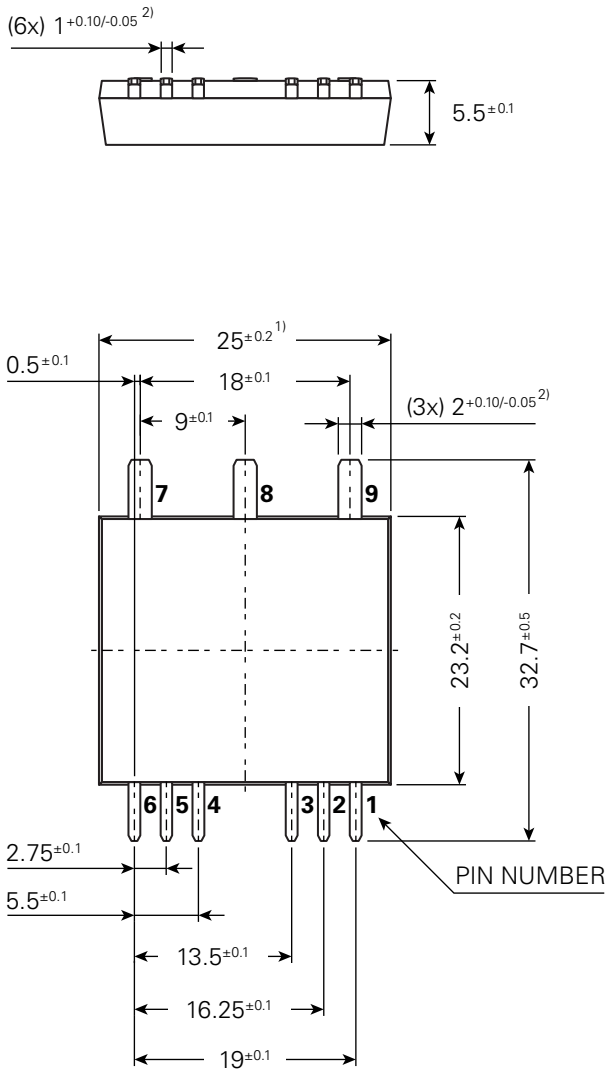

Fig. 36. Typical Reverse Recovery Characteristic of Intrinsic Diode vs. Temperature



Part Outline Drawing



Dimensions in mm (1 mm = 0.0394")

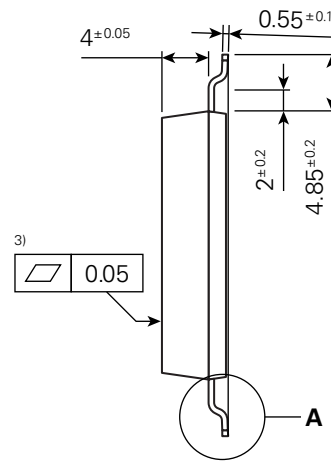
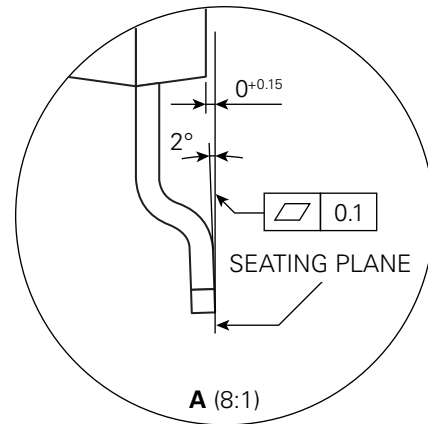

NOTES:

1. Protrusion may add 0.2 mm max. on each side
2. Additional max. 0.05 mm per side by punching misalignment or overlap of dam bar or bending compression
3. DCB AREA 10 to 50 μm convex; position of DCB area in relation to plastic rim: $\pm 25 \mu\text{m}$ (measured 2 mm from Cu rim)
4. Terminal plating: 2 - 6 μm Ni + 10 - 25 μm Sn (galv.) cutting edges may be partially free of plating

Part Number and Marking

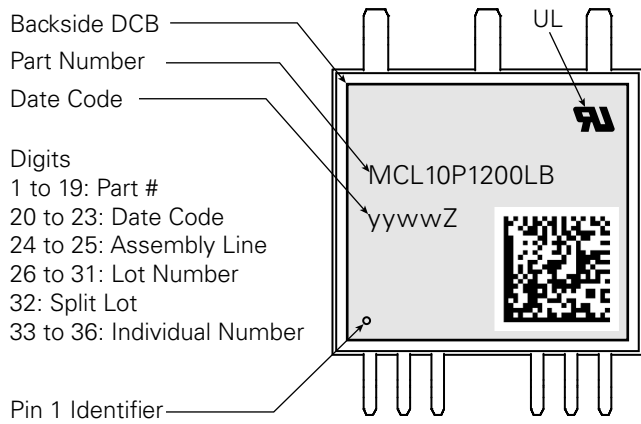

- M = MOSFET
- C = SiC MOSFET
- L = Monolith Gen 1
- 10 = Current Rating [A]
- P = Phase Leg
- 1200 = Reverse Voltage [V]
- LB = SMPD-B
- yy = Year
- ww = Work Week
- Z = Location

Ordering Information

Ordering	Part Number	Marking on Product	Delivering Mode	Base Quantity	Ordering Code
Standard	MCL10P1200LB-TUB	MCL10P1200LB	Tube	20	MCL10P1200LB-TUB
Alternative	MCL10P1200LB-TRR	MCL10P1200LB	Tape & Reel	200	MCL10P1200LB-TRR

Disclaimer Notice

Information furnished is believed to be accurate and reliable. However, users should independently evaluate the suitability of and test each product selected for their own applications. Littelfuse products are not designed for, and may not be used in, all applications. Read complete Disclaimer Notice at <http://www.littelfuse.com/disclaimer-electronics>.



Part of:



