

EN550022 (35.0 x 7.5mm)
DIN RAIL SHOWN

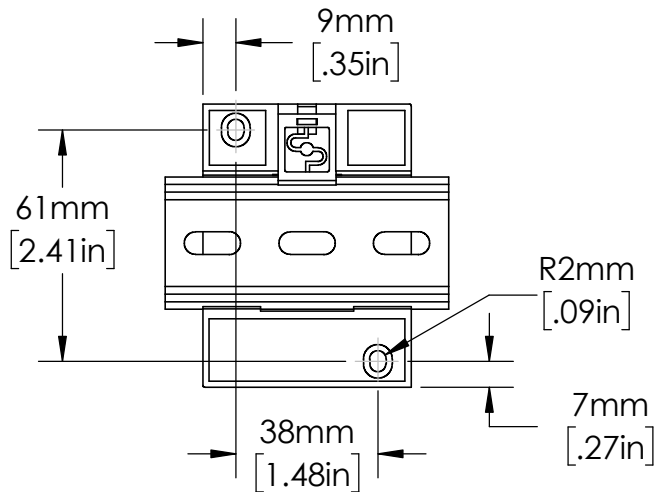

UNLESS NOTED OTHERWISE
DIMENSIONS ARE IN INCHES
TOLERANCES:
TWO PLACE DECIMAL ±0.05
NOT DRAWN TO SCALE

MATERIAL	
NAME	DATE
DRAWN BY J.MOLER	11/29/22

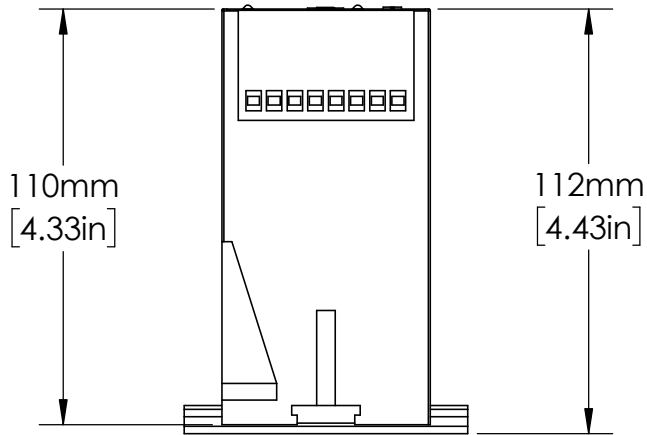
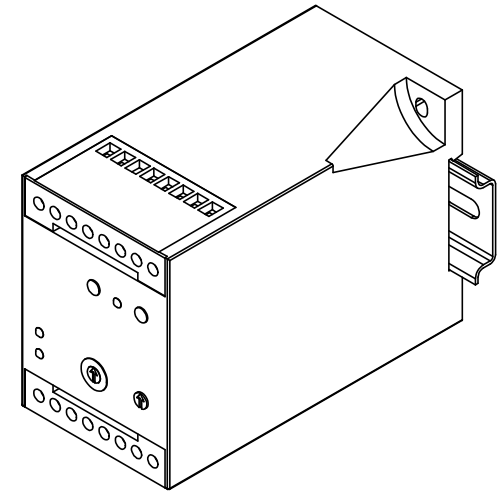

DESCRIPTION:
GROUND FAULT PROTECTION

PART NUMBER:
PGR-4700 SERIES

REV
A

WEIGHT:

SHEET 1 OF 1