



| Parameter           | Rating | Units                |
|---------------------|--------|----------------------|
| Blocking Voltage    | 250    | $V_P$                |
| Load Current        | 50     | $mA_{rms} / mA_{DC}$ |
| On-Resistance (max) | 100    | $\Omega$             |

### Features

- Fast Switching Times: 0.125ms
- Low Off-State Leakage Current: 25nA
- 3750V<sub>rms</sub> Input/Output Isolation
- 100% Solid State
- Low Drive Power Requirements
- FCC Compatible
- VDE Compatible
- No EMI/RFI Generation
- Small 6-Pin Package
- Flammability Rating UL 94 V-0
- Tape & Reel Version Available

### Applications

- Telecommunications
  - Telecom Switching
  - Tip/Ring Circuits
  - Modem Switching (Laptop, Notebook, Pocket Size)
  - Hook Switch
  - Dial Pulsing
  - Ground Start
  - Ringing Injection
- Instrumentation
- Multiplexers
- Data Acquisition
- Electronic Switching
- I/O Subsystems
- Meters (Watt-Hour, Water, Gas)
- Medical Equipment - Patient/Equipment Isolation
- Security
- Industrial Controls

### Description

OMA160 is a 250V, 50mA, 100 $\Omega$ , normally open (1-Form-A) relay. This high performance, optically isolated Solid State Relay provides one of the fastest (125 $\mu$ s) switching times available along with a very low off-state leakage current of 25nA.

### Approvals

- UL Recognized Component: File E76270
- CSA Certified Component: Certificate 1175739
- TUV EN 62368-1: Certificate # B 082667 0008

### Ordering Information

| Part Number | Description                     |
|-------------|---------------------------------|
| OMA160      | 6-Pin DIP (50/Tube)             |
| OMA160S     | 6-Pin Surface Mount (50/Tube)   |
| OMA160STR   | 6-Pin Surface Mount (1000/Reel) |

### Pin Configuration

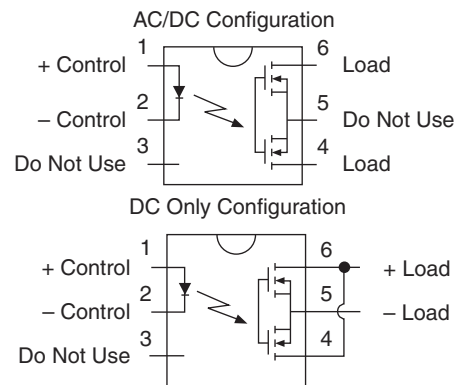

### Switching Characteristics of Normally Open Devices

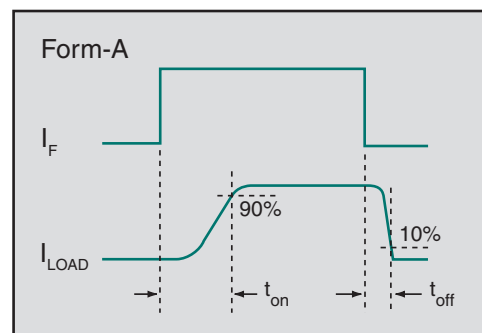

### Absolute Maximum Ratings @ 25°C

| Parameter                            | Ratings     | Units            |
|--------------------------------------|-------------|------------------|
| Blocking Voltage                     | 250         | V <sub>P</sub>   |
| Reverse Input Voltage                | 5           | V                |
| Input Control Current Peak (10ms)    | 50          | mA               |
|                                      | 1           | A                |
| Input Power Dissipation <sup>1</sup> | 150         | mW               |
| Total Power Dissipation <sup>2</sup> | 800         | mW               |
| Isolation Voltage, Input to Output   | 3750        | V <sub>rms</sub> |
| Operational Temperature, Ambient     | -40 to +85  | °C               |
| Storage Temperature                  | -40 to +125 | °C               |

<sup>1</sup> Derate linearly 1.33 mW / °C

<sup>2</sup> Derate output power linearly 6.67 mW / °C

Absolute Maximum Ratings are stress ratings. Stresses in excess of these ratings can cause permanent damage to the device. Functional operation of the device at conditions beyond those indicated in the operational sections of this data sheet is not implied.

Typical values are characteristic of the device at +25°C, and are the result of engineering evaluations. They are provided for information purposes only, and are not part of the manufacturing testing requirements.

### Electrical Characteristics @ 25°C

| Parameter                           | Conditions                                       | Symbol            | Min              | Typ                  | Max  | Units                                |
|-------------------------------------|--|-------------------|------------------|----------------------|------|--------------------------------------|
| <b>Output Characteristics</b>       |  |                   |                  |                      |      |                                      |
| Blocking Voltage                    | I <sub>L</sub> =1μA                              | V <sub>DRM</sub>  | 250              | -                    | -    | V <sub>P</sub>                       |
| Load Current                        | Continuous, AC/DC Configuration                  | I <sub>L</sub>    | -                | -                    | 50   | mA <sub>rms</sub> / mA <sub>DC</sub> |
|                                     |  |                   |                  |                      | 80   |                                      |
|                                     | Continuous, DC Configuration Peak                | t=10ms            | I <sub>LPK</sub> | -                    | -    | ±100                                 |
| On-Resistance <sup>1</sup>          | AC/DC Configuration                              | R <sub>ON</sub>   | -                | 50                   | 100  | Ω                                    |
|                                     | DC Configuration                                 |                   |                  | I <sub>L</sub> =80mA | 15   |                                      |
| Off-State Leakage Current           | V <sub>L</sub> =250V <sub>P</sub>                | I <sub>LEAK</sub> | -                | -                    | 25   | nA                                   |
| Switching Speeds                    | I <sub>F</sub> =10mA, V <sub>L</sub> =10V        | t <sub>on</sub>   | -                | -                    | 125  | μs                                   |
|                                     |  | t <sub>off</sub>  |                  |                      |      |                                      |
| Output Capacitance                  | I <sub>F</sub> =0mA, V <sub>L</sub> =50V, f=1MHz | C <sub>OUT</sub>  | -                | 5                    | -    | pF                                   |
| <b>Input Characteristics</b>        |  |                   |                  |                      |      |                                      |
| Input Control Current to Activate   | I <sub>L</sub> =50mA                             | I <sub>F</sub>    | -                | -                    | 10   | mA                                   |
| Input Control Current to Deactivate | -  | I <sub>F</sub>    | 0.4              | -                    | -    | mA                                   |
| Input Voltage Drop                  | I <sub>F</sub> =10mA                             | V <sub>F</sub>    | 0.9              | 1.42                 | 1.56 | V                                    |
| Reverse Input Current               | V <sub>R</sub> =5V                               | I <sub>R</sub>    | -                | -                    | 10   | μA                                   |
| <b>Common Characteristics</b>       |  |                   |                  |                      |      |                                      |
| Input to Output Capacitance         | V <sub>IO</sub> =0V, f=1MHz                      | C <sub>IO</sub>   | -                | 3                    | -    | pF                                   |

<sup>1</sup> Measurement taken within one second of on-time.

**PERFORMANCE DATA\***

**Typical LED Forward Voltage Drop**  
(N=50,  $I_F=10\text{mA}$ )

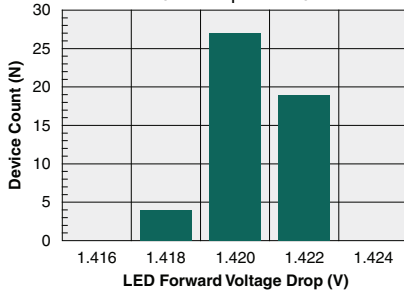

**Typical Turn-On Time**  
(N=50,  $I_F=10\text{mA}$ ,  $I_L=50\text{mA}_{DC}$ )

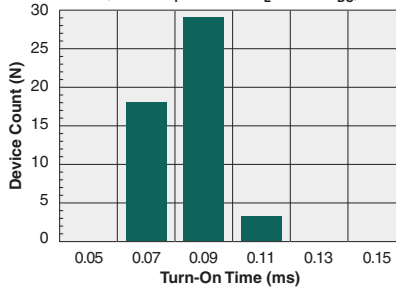

**Typical Turn-Off Time**  
(N=50,  $I_F=10\text{mA}$ ,  $I_L=50\text{mA}_{DC}$ )

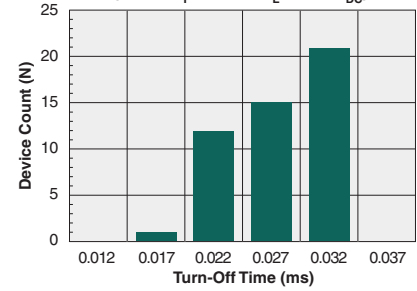

**Typical  $I_F$  for Switch Operation**  
(N=50,  $I_L=50\text{mA}_{DC}$ )

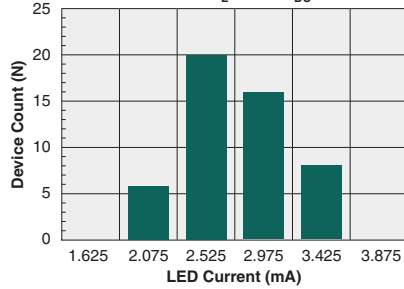

**Typical  $I_F$  for Switch Dropout**  
(N=50,  $I_L=50\text{mA}_{DC}$ )

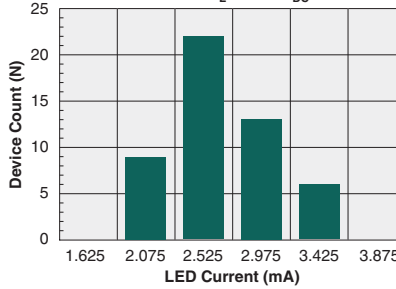

**Typical On-Resistance Distribution**  
(N=50,  $I_F=10\text{mA}$ ,  $I_L=50\text{mA}_{DC}$ )

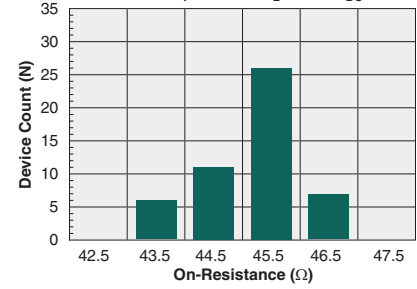

**Typical Blocking Voltage Distribution**  
(N=50)

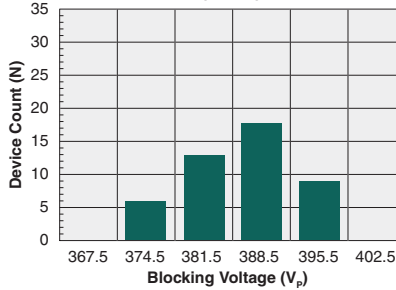

**Typical LED Forward Voltage Drop vs. Temperature**

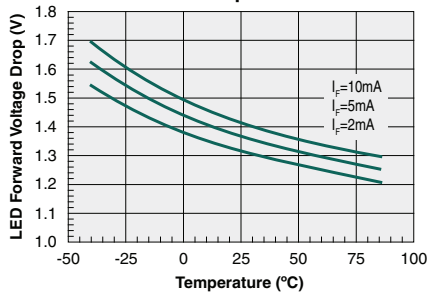

**Typical Turn-On Time vs. LED Forward Current**  
( $I_L=50\text{mA}_{DC}$ )

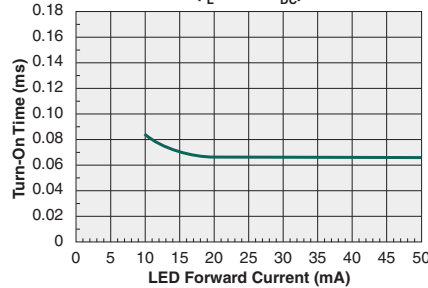

**Typical Turn-Off Time vs. LED Forward Current**  
( $I_L=50\text{mA}_{DC}$ )

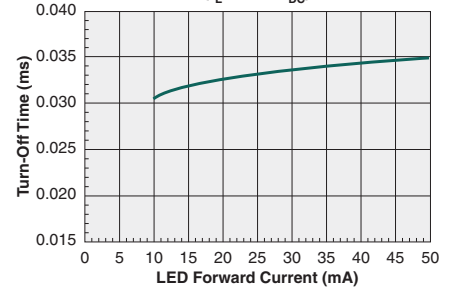

\*Unless otherwise noted, data presented in these graphs is typical of device operation at 25°C.

**PERFORMANCE DATA\***

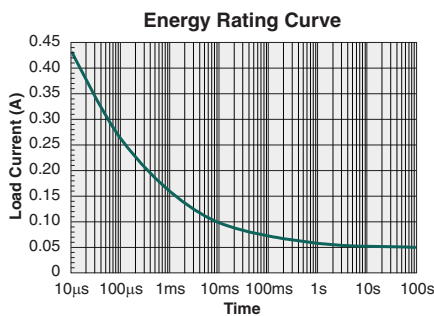
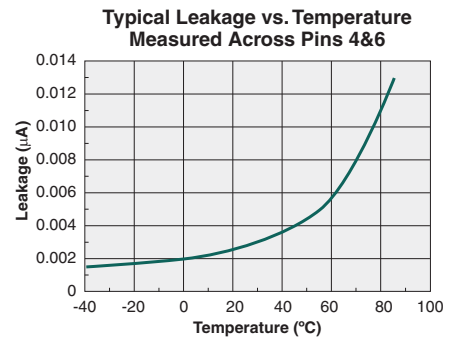
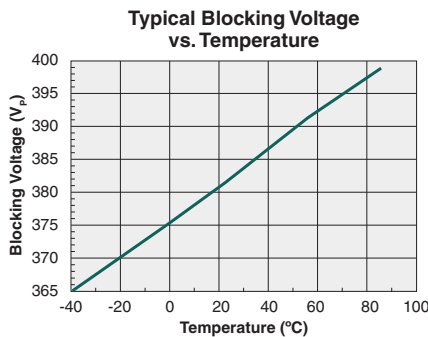
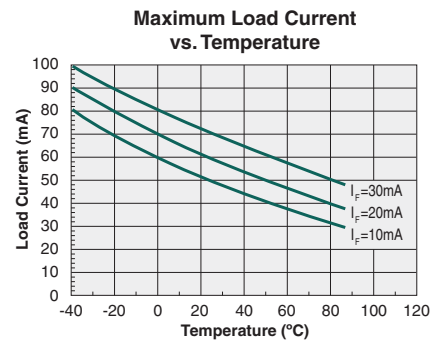
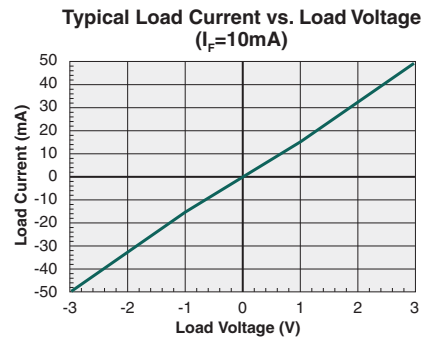
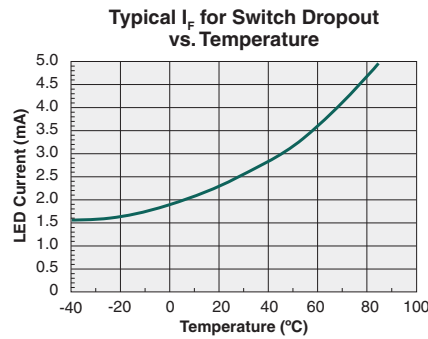
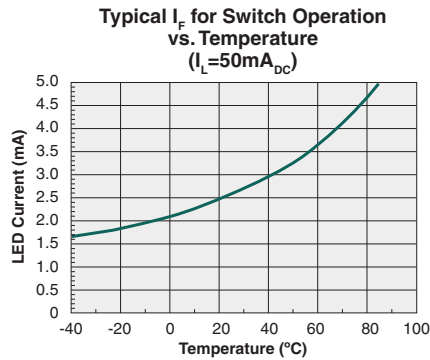
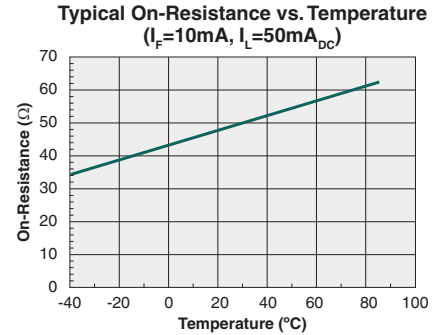
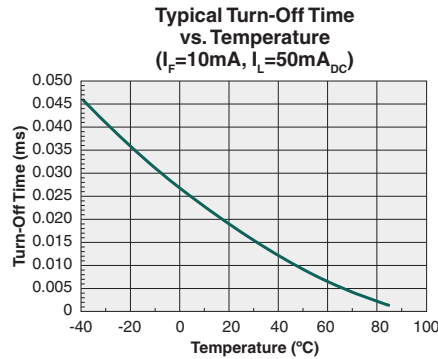
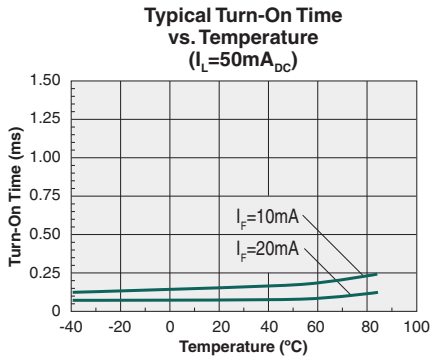

\*Unless otherwise noted, data presented in these graphs is typical of device operation at 25°C.

## Manufacturing Information

### Moisture Sensitivity



All plastic encapsulated semiconductor packages are susceptible to moisture ingress. IXYS Integrated Circuits classifies its plastic encapsulated devices for moisture sensitivity according to the latest version of the joint industry standard, **IPC/JEDEC J-STD-020**, in force at the time of product evaluation. We test all of our products to the maximum conditions set forth in the standard, and guarantee proper operation of our devices when handled according to the limitations and information in that standard as well as to any limitations set forth in the information or standards referenced below.

Failure to adhere to the warnings or limitations as established by the listed specifications could result in reduced product performance, reduction of operable life, and/or reduction of overall reliability.

This product carries a **Moisture Sensitivity Level (MSL)** classification as shown below, and should be handled according to the requirements of the latest version of the joint industry standard **IPC/JEDEC J-STD-033**.

| Device  | Moisture Sensitivity Level (MSL) Classification |
|---------|---|
| OMA160S | MSL 1   |

### ESD Sensitivity



This product is ESD Sensitive, and should be handled according to the industry standard **JESD-625**.

### Soldering Profile

Provided in the table below is the **IPC/JEDEC J-STD-020** Classification Temperature ( $T_C$ ) and the maximum total dwell time ( $t_p$ ) in all reflow processes that the body temperature of these surface mount devices may be ( $T_C - 5$ )°C or greater. The device's body temperature must not exceed the Classification Temperature at any time during reflow soldering processes.

| Device  | Classification Temperature ( $T_C$ ) | Dwell Time ( $t_p$ ) | Max Reflow Cycles |
|---------|--------------------------------------|----------------------|-------------------|
| OMA160S | 250°C                                | 30 seconds           | 3                 |

For through-hole devices, the maximum pin temperature and maximum dwell time through all solder waves is provided in the table below. Dwell time is the interval beginning when the pins are initially immersed into the solder wave until they exit the solder wave. For multiple waves, the dwell time is from entering the first wave until exiting the last wave. During this time, pin temperatures must not exceed the maximum temperature given in the table below. Body temperature of the device must not exceed the limit shown in the table below at any time during the soldering process.

| Device | Maximum Pin Temperature | Maximum Body Temperature | Maximum Dwell Time | Wave Cycles |
|--------|-------------------------|--------------------------|--------------------|-------------|
| OMA160 | 260°C                   | 250°C                    | 10 seconds*        | 1           |

\*Total cumulative duration of all waves.

### Board Wash

IXYS Integrated Circuits recommends the use of no-clean flux formulations. Board washing to reduce or remove flux residue following the solder reflow process is acceptable provided proper precautions are taken to prevent damage to the device. These precautions include but are not limited to: using a low pressure wash and providing a follow up bake cycle sufficient to remove any moisture trapped within the device due to the washing process. Due to the variability of the wash parameters used to clean the board, determination of the bake temperature and duration necessary to remove the moisture trapped within the package is the responsibility of the user (assembler). Cleaning or drying methods that employ ultrasonic energy may damage the device and should not be used. Additionally, the device must not be exposed to halide flux or solvents.



**Mechanical Dimensions**

**OMA160**

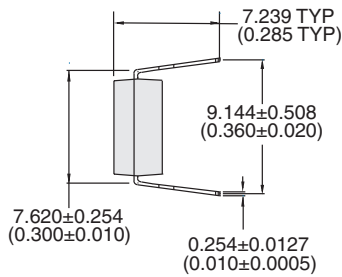
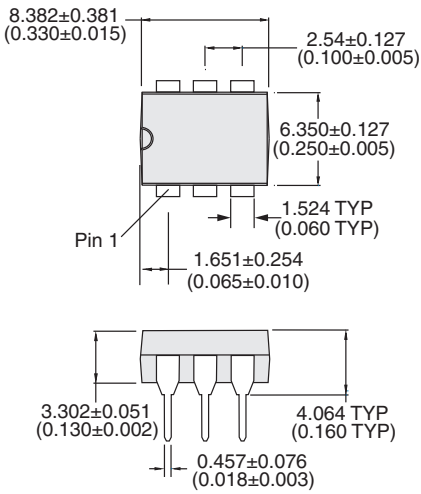

**PCB Hole Pattern**

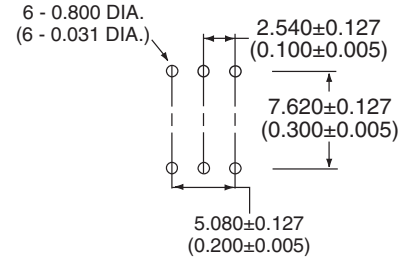

Controlling dimension: inches

Dimensions  
mm  
(inches)

**OMA160S**

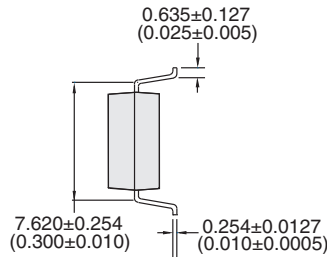
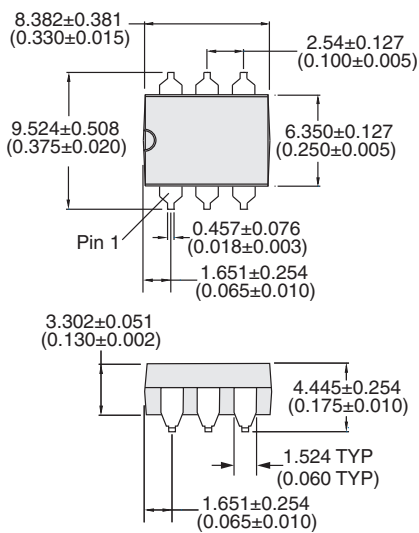

**PCB Land Pattern**

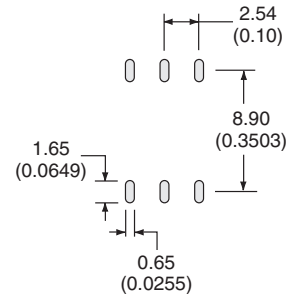

Controlling dimension: inches

Dimensions  
mm  
(inches)

### OMA160STR Tape & Reel

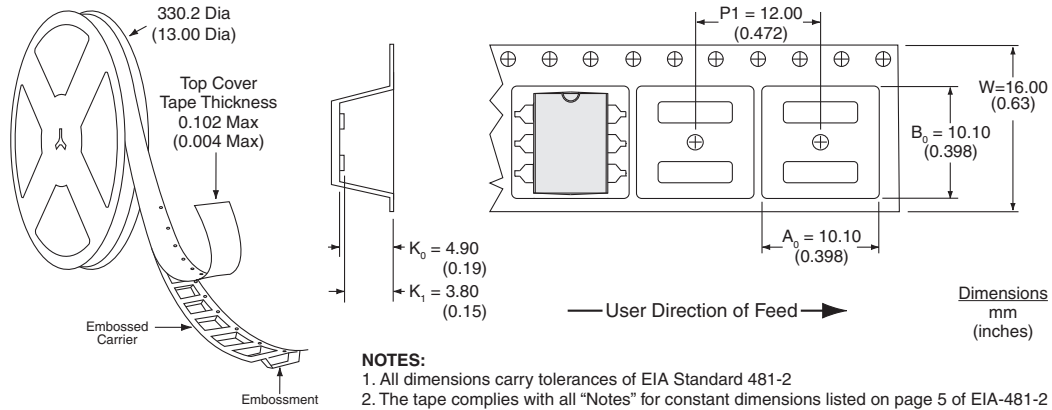

For additional information please visit our website at: <https://www.ixysic.com>



Disclaimer Notice - Information furnished is believed to be accurate and reliable. However, users should independently evaluate the suitability of and test each product selected for their own applications. Littelfuse products are not designed for, and may not be used in, all applications. Read complete Disclaimer Notice at <https://www.littelfuse.com/disclaimer-electronics>.

Specification: DS-OMA160-R13  
©Copyright 2021, Littelfuse, Inc.  
All rights reserved. Printed in USA.  
11/4/2021