

MM
 25
 05
 22
 28
 57
 51
 97

IN
 .010
 .750
 .875
 .900
 1.440
 1.910
 2.440

M-700

APPLICABLE SAE STANDARD
 OR RECOMMENDED PRACTICE
 SAE J259

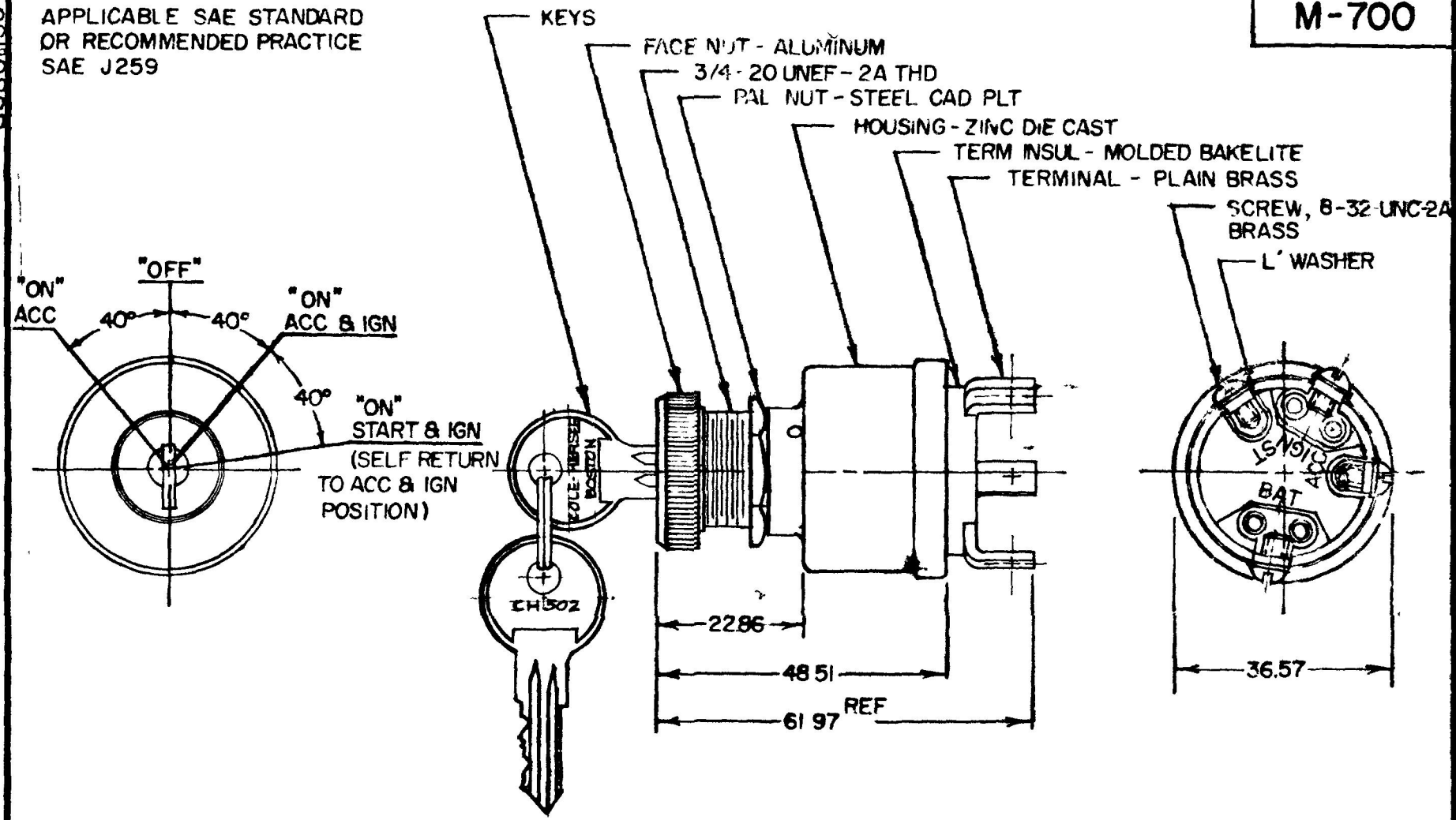

NOTE
 8367 ADAPTER FACE NUT PERMITS ASS'Y OF
 SWITCH TO 19 05 & 22 22 DIA PANEL HOLES

METRIC

DO NOT SCALE

LET	WAS	DATE	BY	LET	WAS	DATE	BY	MATERIAL	DRAWN	CHECKED	APPRV D	SCALE	DATE DRAWN
								— # —	AA	9-24-59		1:1	1-14-59
								FINISH	 Cole Hersee Co. <small>20 OLD COLONY AVENUE SOUTH BOSTON MA U.S.A. 02 27</small>				DATE BLUEPRINT
								— # —					
				H	REV CASE ECN 22209	9-283	P ₃	TOLERANCES	IGN & START SWITCH				M-700
			G	REDRAWN	9-1978	R	FRACTIONAL ± DECIMAL ±.25						

CH-188 (4-78)