

LSIC2SD120D10A 1200 V, 10 A SiC Schottky Barrier Diode

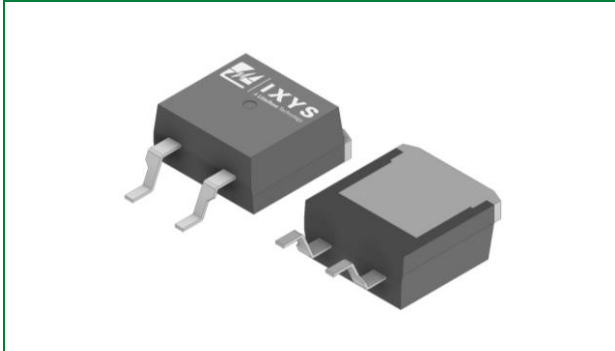

Agency Approvals and Environmental

Environmental Approvals



Pinout Diagram TO-263-2L

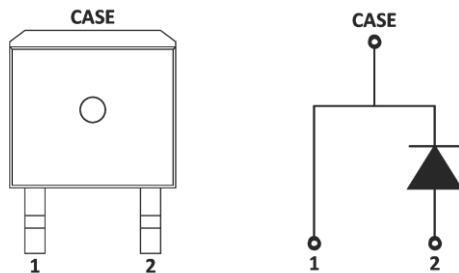

Product Summary

Characteristic	Value	Unit
V_{RRM}	1200	V
$I_F (T_C \leq 135\text{ }^\circ\text{C})$	15	A
$Q_C (V_R: 0-800\text{ V})$	56	nC

Features

- AEC-Q101 Qualified
- MSL 1 Rated
- Positive temperature coefficient for safe operation and ease of paralleling
- 175 °C maximum operating junction temperature
- Excellent surge capability
- Extremely fast, temperature-independent switching behavior
- Dramatically reduced switching losses compared to Si bipolar diodes
- RoHS compliant, lead-free, and halogen-free

Applications

- Boost diodes in PFC or DC/DC stages
- Switch-mode power supplies
- Solar inverters
- Uninterruptable power supplies
- Industrial motor drives
- Battery chargers
- High speed rectifier

1. Maximum Ratings 3

2. Thermal Characteristics 3

3. Electrical Characteristics 3

4. Performance Curves 4

5. Diode V_F Model for Simulation 5

6. Package Dimensions 6

7. Part Numbering and Marking 6

8. Packing Options 6

9. Packing Specifications 7

1. Maximum Ratings

Characteristic	Symbol	Conditions	Value	Unit
Repetitive Peak Reverse Voltage	V_{RRM}	-	1200	V
DC Blocking Voltage	V_R	-	1200	V
Continuous Forward Current	I_F	$T_C = 25\text{ }^\circ\text{C}$	32	A
		$T_C = 135\text{ }^\circ\text{C}$	15	
		$T_C = 154\text{ }^\circ\text{C}$	10	
Non-repetitive Forward Surge Current	I_{FSM}	$T_C = 25\text{ }^\circ\text{C}$, $t_p = 10\text{ ms}$, Half sine pulse	80	A
I^2t	$\int I^2 dt$	$T_C = 25\text{ }^\circ\text{C}$, $t_p = 10\text{ ms}$, Half sine pulse	32	A^2s
Power Dissipation	P_{Tot}	$T_C = 25\text{ }^\circ\text{C}$	150	W
		$T_C = 110\text{ }^\circ\text{C}$	65	
Operating Junction Temperature	T_J	-	-55 to 175	$^\circ\text{C}$
Storage Temperature	T_{STG}	-	-55 to 150	$^\circ\text{C}$
Lead Temperature for Soldering (MSL 1 Rated)	T_{SOLD}	-	260	$^\circ\text{C}$

2. Thermal Characteristics

Characteristic	Symbol	Value	Unit
Maximum Thermal Resistance, junction-to-case	$R_{thJC, max}$	1.0	$^\circ\text{C/W}$

3. Electrical Characteristics

Characteristic	Symbol	Conditions	Value			Unit
			Min	Typ	Max	
Forward Voltage	V_F	$I_F = 10\text{ A}$, $T_J = 25\text{ }^\circ\text{C}$	-	1.5	1.8	V
		$I_F = 10\text{ A}$, $T_J = 175\text{ }^\circ\text{C}$	-	2	-	
Reverse Current	I_R	$V_R = 1200\text{ V}$, $T_J = 25\text{ }^\circ\text{C}$	-	<1	100	μA
		$V_R = 1200\text{ V}$, $T_J = 175\text{ }^\circ\text{C}$	-	4	-	
Total Capacitance	C	$V_R = 1\text{ V}$, $f = 1\text{ MHz}$	-	580	-	pF
		$V_R = 400\text{ V}$, $f = 1\text{ MHz}$	-	53	-	
		$V_R = 800\text{ V}$, $f = 1\text{ MHz}$	-	40	-	
Total Capacitive Charge	Q_C	$V_R = 800\text{ V}$, $Q_C = \int C(V) dV$	-	56	-	nC
Capacitance Stored Energy	E_C	$V_R = 800\text{ V}$	-	12.8	-	μJ

4. Performance Curves

Figure 1. Typical Forward Characteristics

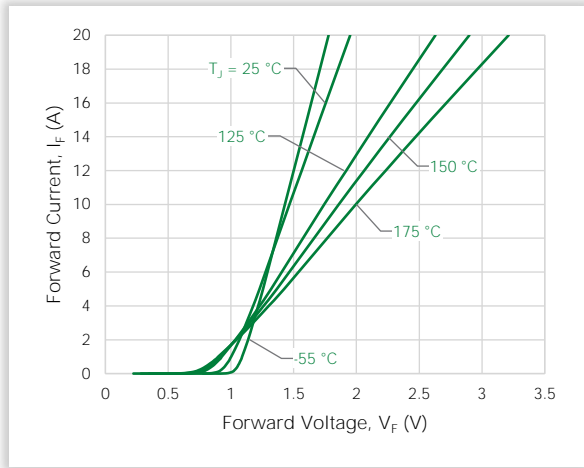

Figure 2. Typical Reverse Characteristics

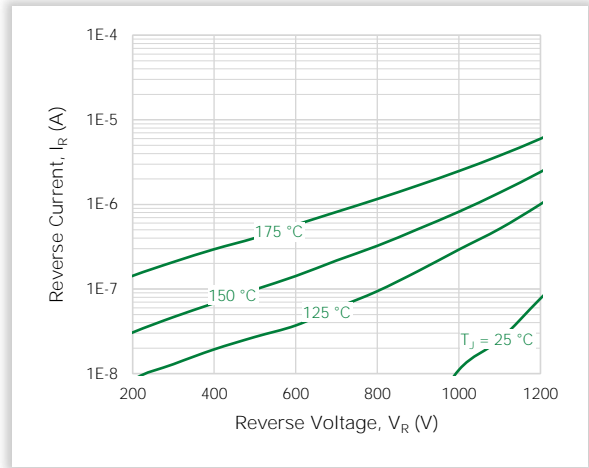

Figure 3. Power Derating

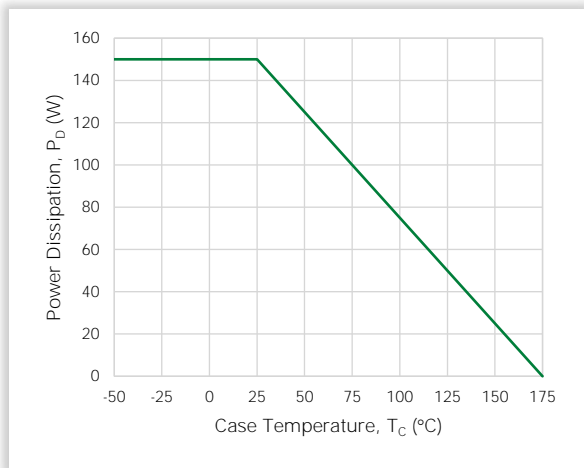

Figure 4. Current Derating

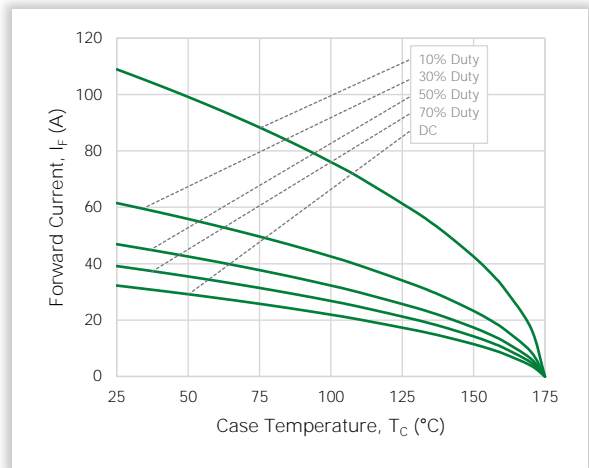

Figure 5. Capacitance vs. Reverse Voltage

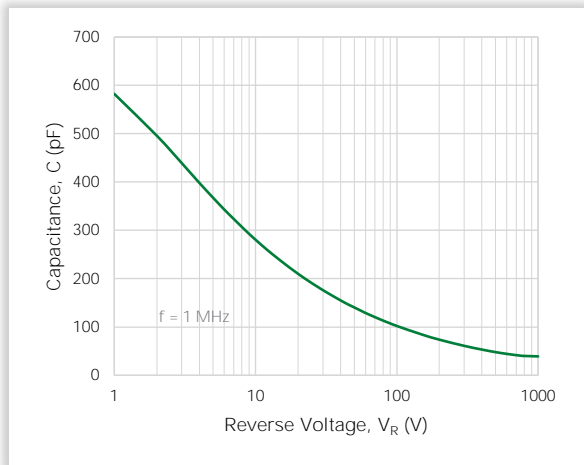

Figure 6. Capacitive Charge vs. Reverse Voltage

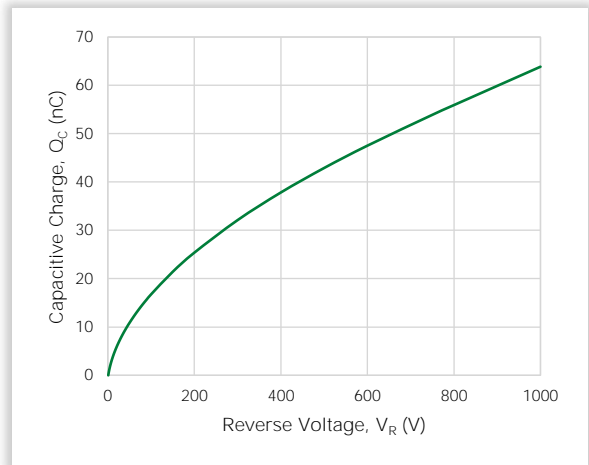

Figure 7. Stored Energy vs. Reverse Voltage

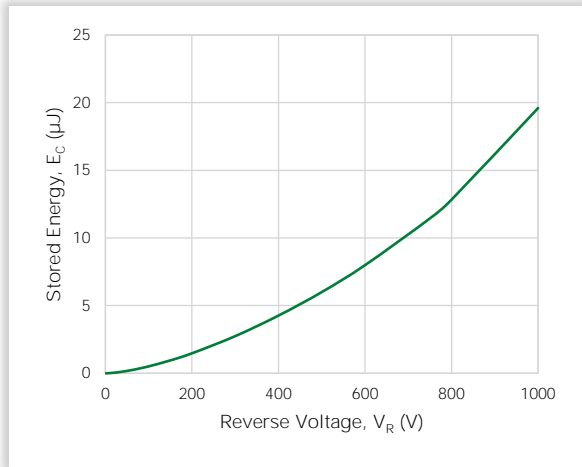
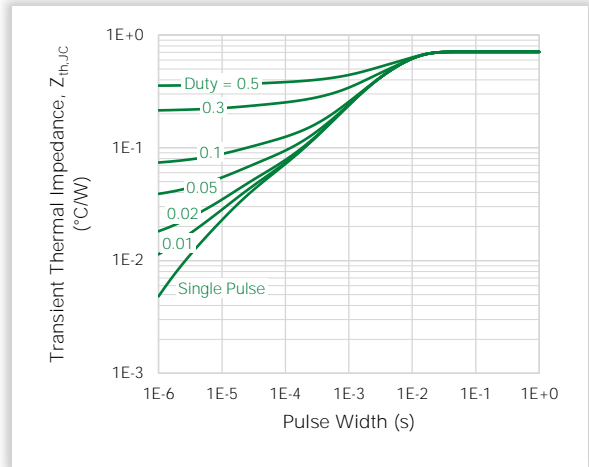
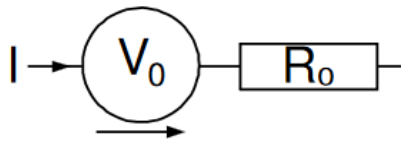

Figure 8. Transient Thermal Impedance



5. Diode V_F Model for Simulation



$$V_F(T_J) = V_0 + IR_0$$

$$V_0 = -1.11 \times 10^{-3} \cdot T_J + 1.01 \times 10^0$$

$$R_0 = 1.61 \times 10^{-6} \cdot T_J^2 + 1.50 \times 10^{-4} \cdot T_J + 4.35 \times 10^{-2}$$

Notes:

- T_J is junction temperature in °C
- Range valid from 25 °C to 175 °C
- Model represents performance of a typical part

6. Package Dimensions

TO-263-2L Package

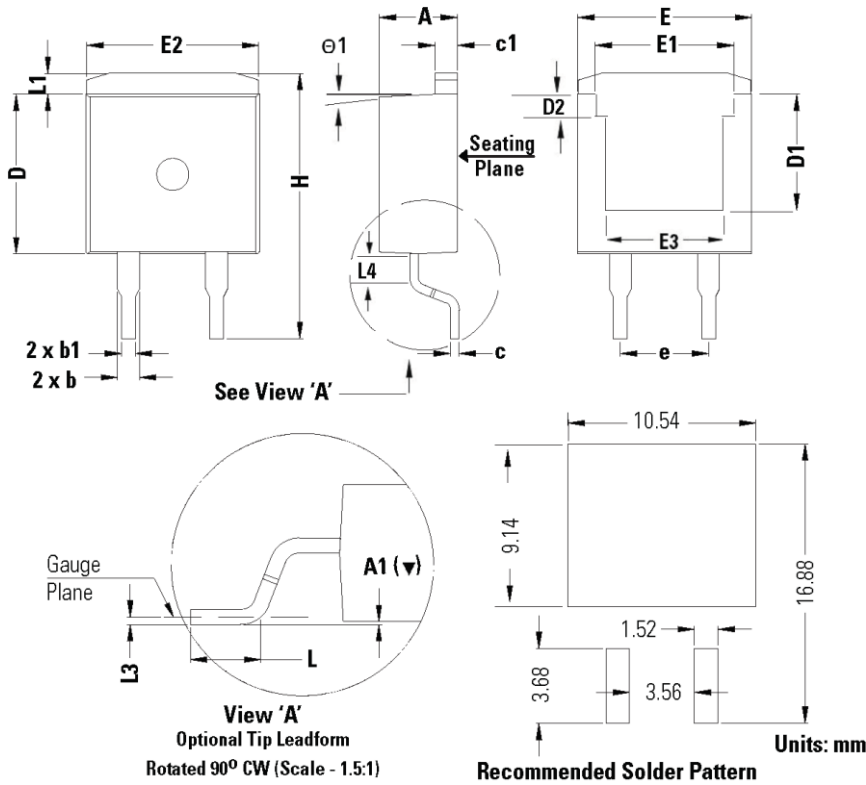

Symbol	Millimeters		
	Min	Nom	Max
A	4.30	4.60	4.70
A1(▼)	0.00	-	0.20
b	0.70	0.80	0.90
b1	1.18	1.28	1.38
c	0.45	0.50	0.60
c1	1.25	1.30	1.40
D	9.00	9.20	9.40
D1	6.70	6.90	7.10
D2	1.10	1.30	1.50
E	9.80	10.00	10.20
E1	8.20	8.40	8.60
E2	9.70	9.90	10.10
E3	7.80	8.00	8.20
e	5.08 BSC		
H	15.00	15.30	15.60
L	2.00	2.30	2.60
L1	1.00	1.20	1.40
L3	0.254 BSC		
L4	(2.00)		
Ø1	(3°)		

Notes:

1. These dimensions do not include protrusions of the mold.
2. The "()" mark is the reference.
3. Coplanarity : Max 0.10mm
4. Metal finish – matte pure tin plating except trim area.
5. All plastic surfaces are polish finish.
6. Nominal 0.25 radius on all body edges and corners.

7. Part Numbering and Marking

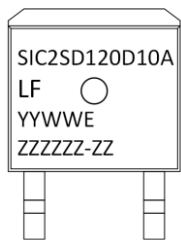

- SIC = SiC Diode
- 2 = Gen2
- SD = Schottky Diode
- 120 = Voltage Rating (1200 V)
- D = TO-263-2L
- 10 = Current Rating (10 A)
- A = AEC-Q101 Qualified
- YY = Year
- WW = Week
- E = Special Code
- ZZZZZZ-ZZ = Lot Number

8. Packing Options

Part Number	Marking	Packing Mode	M.O.Q.
LSIC2SD120D10A	SIC2SD120D10A	Tape & Reel	800

9. Packing Specifications

TO-263 Carrier Tape and Reel Specifications

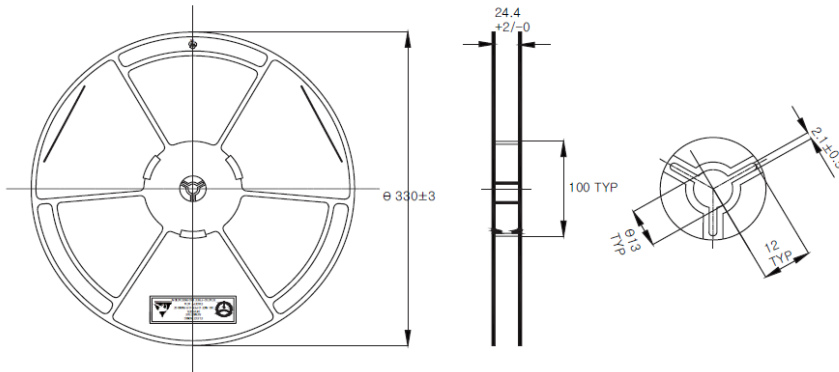
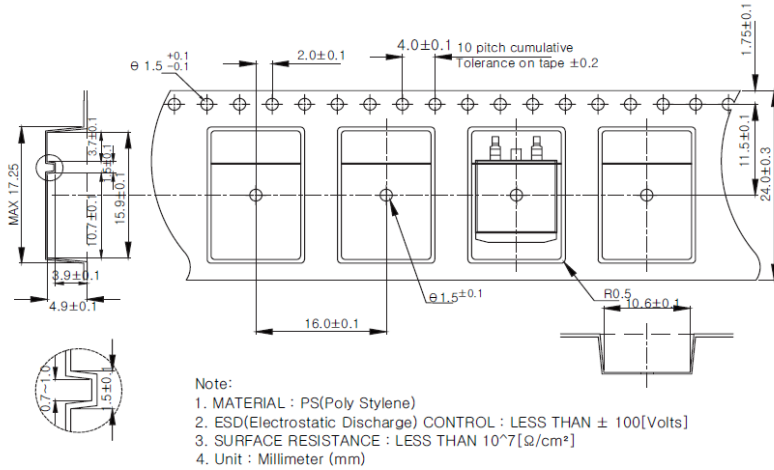

For additional information please visit www.Littelfuse.com/powersemi

Disclaimer Notice - Littelfuse products are not designed for, and shall not be used for, any purpose (including, without limitation, automotive, military, aerospace, medical, life-saving, life-sustaining or nuclear facility applications, devices intended for surgical implant into the body, or any other application in which the failure or lack of desired operation of the product may result in personal injury, death, or property damage) other than those expressly forth in applicable Littelfuse product documentation. Littelfuse shall not be liable for any claims or damages arising out of products used in applications not expressly intended by Littelfuse as set forth in applicable Littelfuse documentation.

Read complete Disclaimer Notice at www.littelfuse.com/disclaimer-electronics