

OT08PC
RELAY SOCKET

EN550022 (35.0 x 7.5)
DIN RAIL SHOWN

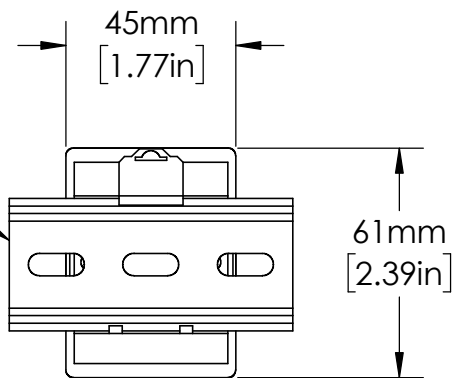

UNLESS NOTED OTHERWISE
DIMENSIONS ARE IN INCHES
TOLERANCES:
TWO PLACE DECIMAL ±0.05
NOT DRAWN TO SCALE

MATERIAL	
NAME	DATE
DRAWN BY J.MOLER	12/20/22



DESCRIPTION: PUMP AND LIQUID
LEVEL CONTROL

PART NUMBER: LLC4 SERIES

REV
A

WEIGHT: SHEET 1 OF 1