




### TMOV®34S Varistor Series



#### Description

The Littelfuse TMOV®34S thermally protected varistor series consists of a 34mm square format varistor element (MOV) with an integral thermally activated element. This element is designed to open in the event of overheating due to abnormal overvoltage, limited current conditions. Certain TMOV®34S varistor are offered with a "monitor" lead which may be connected to signalling circuitry to indicate if the MOV has been disconnected from the circuit. TMOV®34S varistor series offer quick thermal response due to the close proximity of the integrated thermal element to the MOV body. The integrated configuration also offers lower inductance than most discrete solutions resulting in improved clamping performance to fast over voltage transients.

#### Agency Approvals

Agency	Standard	Agency File Number
	UL1449	E320116
	QC42201-C001, QC42201-A001, IEC 60950-1 (Annex Q)	IECQ-C BSI 15.0009
	IEC 61051-1, IEC 61051-2, IEC 60950-1 (Annex Q)	40021525

#### Absolute Maximum Ratings

\* For ratings of individual members of a series, see Device Ratings and Specifications chart

Continuous	TMOV34S Varistor Series	Units
<b>Steady State Applied Voltage:</b>		
AC Voltage Range ( $V_{MACIRMS}$ )	115 to 750	V
<b>Transients:</b>		
Peak Pulse Current ( $I_{TM}$ )		
For 8/20 $\mu$ s Current Wave, single pulse	up to 40,000	A
Single Pulse Energy Range		
For 2ms Current Wave	280 to 1200	J
Operating Ambient Temperature Range ( $T_A$ )	-55 to + 85	°C
Storage Temperature Range ( $T_{STG}$ )	-55 to + 125	°C
Temperature Coefficient ( $\alpha$ ) of Clamping Voltage ( $V_C$ ) at Specified Test Current	<0.01	%/°C
Hi-Pot Encapsulation (Isolation Voltage Capability)	2500	V
COATING Insulation Resistance	1000	M $\Omega$

\* Contact your Littelfuse product representative to discuss alternatives and for additional information.

**CAUTION:** Stresses above those listed in "Absolute Maximum Ratings" may cause permanent damage to the device. This is a stress only rating and operation of the device at these or any other conditions above those indicated in the operational sections of this specification is not implied.

#### Features

- High peak current rating to 40 kA
- 55°C to +85°C operating temp
- RoHS Compliant and Lead-free Available
- Alternative design available with narrow 3mm wide monitor (right) lead
- Alternative design available with 2 leads only (no monitor lead)

#### Applications

- SPD Products
- AC Panel Protection Modules
- UPS (Uninterruptable Power Supply)
- Inverters
- AC/DC Power Supplies

#### Additional Information



Datasheet



Resources



Samples

### TMOV® 34S Series Ratings & Specifications - Standard 3 Lead Design

Lead-free and RoHS Compliant Models	Branding	Maximum Rating (85°C)				Specifications (25°C)			
		Continuous		Energy 2ms	Peak Current 8 x 20µs	Varistor Voltage at 1mA Test Current		Maximum Clamping Volt V <sub>c</sub> at 200A Current (8/20µs)	Typical Capacitance f = 1MHz
		AC Volts	DC Volts			V <sub>N(DC)</sub> Min	V <sub>N(DC)</sub> Max		
		V <sub>M(AC)RMS</sub> (V)	V <sub>M(DC)</sub> (V)	W <sub>TM</sub> 1 x Pulse (J)	I <sub>TM</sub> 1 x Pulse (A)			V <sub>c</sub> (V)	C (pF)
TMOV34S111MP	TMOV34S111MP	115	150	280	40000	162	198	305	11500
TMOV34S131MP	TMOV34S131MP	130	175	310	40000	184.5	225.5	345	10000
TMOV34S141MP	TMOV34S141MP	140	188	340	40000	198	242	375	9000
TMOV34S151MP	TMOV34S151MP	150	200	360	40000	216	264	405	8000
TMOV34S181MP	TMOV34S181MP	180	240	400	40000	256	312	488	6800
TMOV34S201MP	TMOV34S201MP	200	265	430	40000	288	352	540	6500
TMOV34S251MP	TMOV34S251MP	250	330	490	40000	351	429	650	5000
TMOV34S271MP	TMOV34S271MP	275	369	550	40000	387	473	730	4500
TMOV34S301MP	TMOV34S301MP	300	400	590	40000	423	517	780	4050
TMOV34S321MP	TMOV34S321MP	320	420	640	40000	459	561	830	3800
TMOV34S331MP	TMOV34S331MP	330	435	650	40000	476	581	855	3700
TMOV34S351MP	TMOV34S351MP	350	460	700	40000	504	616	910	3500
TMOV34S391MP	TMOV34S391MP	385	506	800	40000	558	682	1005	3300
TMOV34S421MP	TMOV34S421MP	420	560	910	40000	612	748	1130	3000
TMOV34S461MP	TMOV34S461MP	460	610	960	40000	643.5	786.5	1188	2800
TMOV34S481MP	TMOV34S481MP	480	640	960	40000	675	825	1240	2700
TMOV34S511MP	TMOV34S511MP	510	675	960	40000	738	902	1350	2500
TMOV34S551MP	TMOV34S551MP	550	700	965	40000	770	939	1415	2250
TMOV34S571MP	TMOV34S571MP	575	730	990	40000	819	1001	1480	2200
TMOV34S621MP	TMOV34S621MP	620	800	1010	40000	900	1100	1589	2100
TMOV34S661MP	TMOV34S661MP	660	850	1030	40000	945	1155	1720	2000
TMOV34S681MP	TMOV34S681MP	680	890	1100	40000	980	1195	1772	1970
TMOV34S751MP	TMOV34S751MP	750	970	1200	40000	1080	1320	2000	1800

**Notes :**

Same ratings and specifications apply to 2 leaded alternative design. Replace 'M' with 'E' in part number. Refer to Part Numbering System at the end of this document.

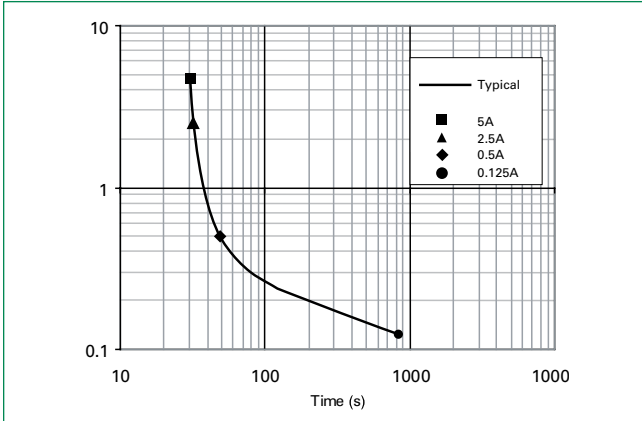
### Ratings & Specifications - Alternative 2 Lead Design

Lead-free and RoHS Compliant Models	Branding	Maximum Rating (85°C)				Specifications (25°C)			
		Continuous		Energy 2ms $W_{TM}$ 1 x Pulse	Peak Current $I_{TM}$ 1 x Pulse	Varistor Voltage at 1mA Test Current		Maximum Clamping Volt $V_c$ at 200A Current (8/20µs)	Typical Capacitance $f = 1MHz$  C
		AC Volts	DC Volts			$V_{N(DC)}$ Min	$V_{N(DC)}$ Max		
Part Number		$V_{M(AC)RMS}$ (V)	$V_{M(AC)}$	(J)	(A)	(V)	(V)	$V_c$ (V)	C (pF)
TMOV34S111EP	TMOV34S111EP	115	150	280	40000	162	198	305	11500
TMOV34S131EP	TMOV34S131EP	130	175	310	40000	184.5	225.5	345	10000
TMOV34S141EP	TMOV34S141EP	140	188	340	40000	198	242	375	9000
TMOV34S151EP	TMOV34S151EP	150	200	360	40000	216	264	405	8000
TMOV34S181EP	TMOV34S181EP	180	240	400	40000	256	312	488	6800
TMOV34S201EP	TMOV34S201EP	200	265	430	40000	288	352	540	6500
TMOV34S251EP	TMOV34S251EP	250	330	490	40000	351	429	650	5000
TMOV34S271EP	TMOV34S271EP	275	369	550	40000	387	473	730	4500
TMOV34S301EP	TMOV34S301EP	300	400	590	40000	423	517	780	4050
TMOV34S321EP	TMOV34S321EP	320	420	640	40000	459	561	830	3800
TMOV34S331EP	TMOV34S331EP	330	435	650	40000	476	581	855	3700
TMOV34S351EP	TMOV34S351EP	350	460	700	40000	504	616	910	3500
TMOV34S391EP	TMOV34S391EP	385	506	800	40000	558	682	1005	3300
TMOV34S421EP	TMOV34S421EP	420	560	910	40000	612	748	1130	3000
TMOV34S461EP	TMOV34S461EP	460	610	960	40000	643.5	786.5	1188	2800
TMOV34S481EP	TMOV34S481EP	480	640	960	40000	675	825	1240	2700
TMOV34S511EP	TMOV34S511EP	510	675	960	40000	738	902	1350	2500
TMOV34S551EP	TMOV34S551EP	550	700	965	40000	770	939	1415	2250
TMOV34S571EP	TMOV34S571EP	575	730	990	40000	819	1001	1480	2200
TMOV34S621EP	TMOV34S621EP	620	800	1010	40000	900	1100	1589	2100
TMOV34S661EP	TMOV34S661EP	660	850	1030	40000	945	1155	1720	2000
TMOV34S681EP	TMOV34S681EP	680	890	1100	40000	980	1195	1772	1970
TMOV34S751EP	TMOV34S751EP	750	970	1200	40000	1080	1320	2000	1800

**Notes :**

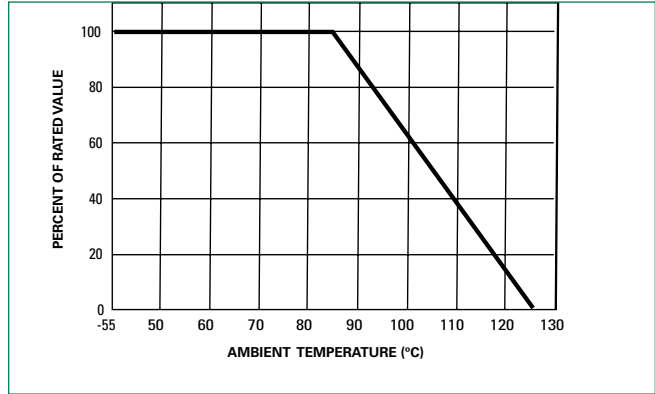
Same ratings and specifications apply to 3 leaded design. Replace 'E' with 'M' in part number. Refer to Part Numbering System at the end of this document.

**Fig. 1 Typical time to open circuit under UL1449 Abnormal Overvoltage Limited Current Test**



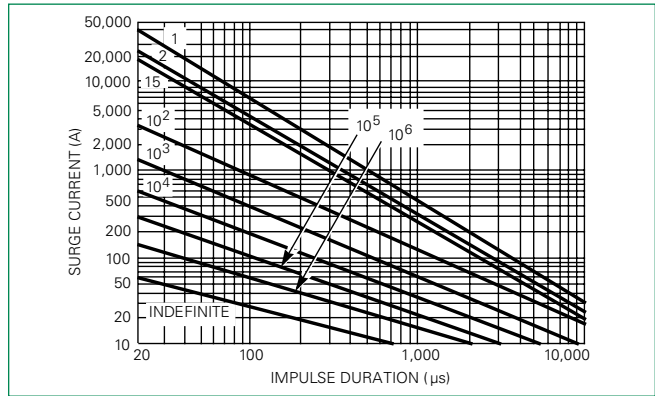
**Note:** The Industrial TMOV<sup>®</sup>34S varistor are intended, in conjunction with appropriate enclosure design, to help facilitate SPD module compliance to UL 1449 (Abnormal Overvoltage Limited Current Requirements). Under these extreme abnormal overvoltage conditions, the units will exhibit substantial heating and potential venting prior to opening. Modules should be designed to contain this possibility. Application testing is strongly recommended.

**Fig. 2. Peak Current & Energy Derating Curve**

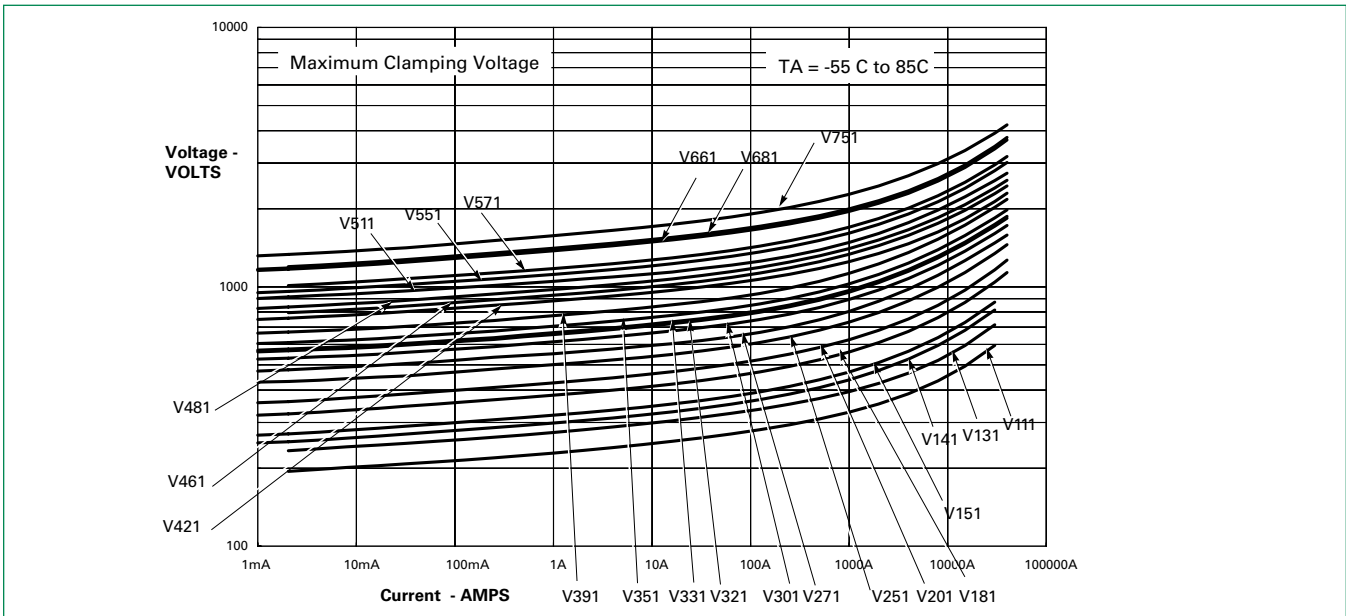


For applications exceeding 85°C ambient temperature, the peak surge current and energy ratings must be reduced as shown.

**Fig. 3 Pulse Rating Curve**

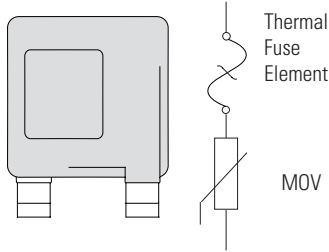


**Fig. 4 V-I Characteristic Curves**



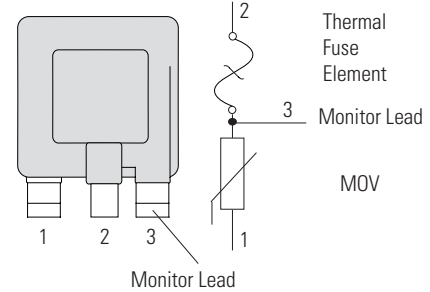
**Lead Configurations**

TMOV<sup>®</sup>34S Varistor "E" 2-Lead Varistor



Note: MOVs are non-polarized passive elements

TMOV<sup>®</sup>34S Varistor "M" 3-Lead Varistor

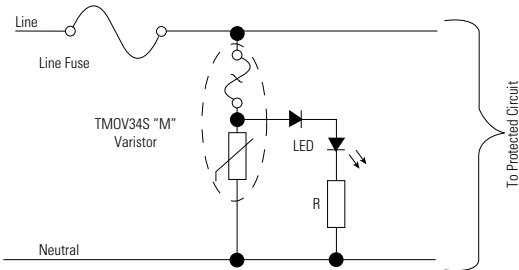


**TMOV<sup>®</sup>34S Varistor Application Examples**

The application examples below show how the monitor lead on the TMOV<sup>®</sup>34S varistor can be used to indicate that the thermal element has been opened. This signifies that the circuit is no longer protected from transients by the MOV.

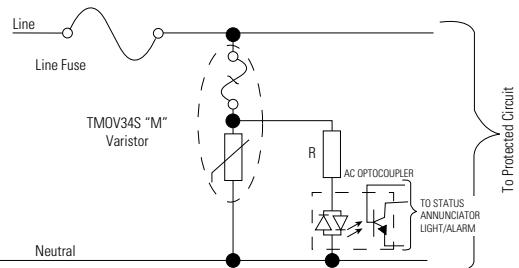
**Application Example 1**

In this case, the LED is normally on, and is off when the thermal element opens.



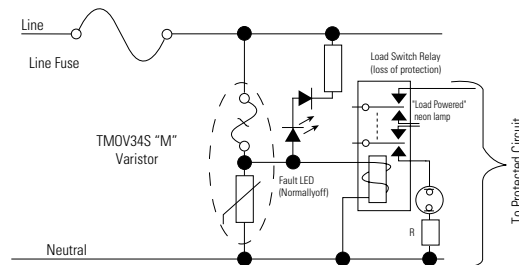
**Application Example 2**

This circuit utilizes an optocoupler to provide galvanic isolations between the TMOV<sup>®</sup>34S varistor and the indicating or alarm circuitry.



**Application Example 3**

This circuit illustrates the use of the monitoring lead of the TMOV<sup>®</sup>34S varistor to ensure that equipment is only operated when overvoltage protection present. In normal operation the load switch relay solenoid is powered via the monitor lead of the TMOV<sup>®</sup>34S varistor. In the event of the thermal element being activated, the relay will de-activate, cutting power to the protected circuit and the fault LED will illuminate.



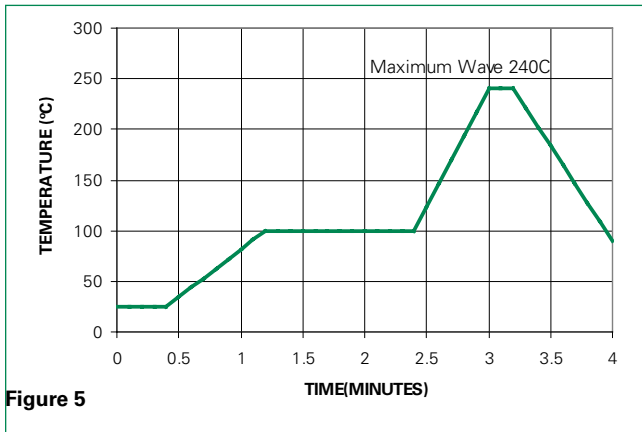
Please note: Indicator circuits are provided as a guideline only. Verification of actual indicator circuitry is the responsibility of the end user. Component values selected must be appropriate for the specific AC line voltage service and application.

### Wave Solder Profile

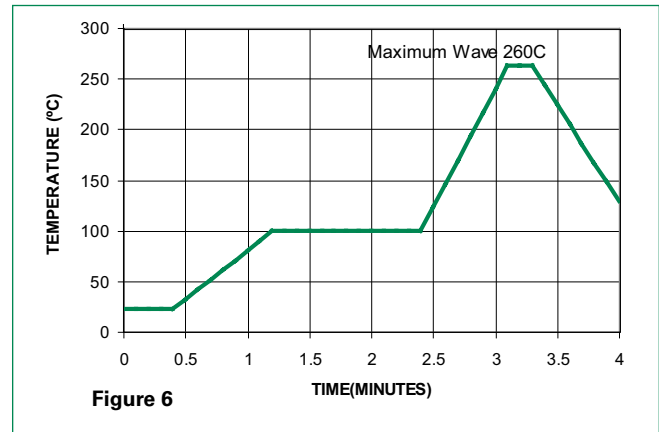
Because the TMOV<sup>®</sup>34S Series varistors contain a thermal protection device, care must be taken when soldering the devices into place. Two soldering methods are possible. Firstly, hand soldering:

It is recommended to heat-sink the leads of the device. Secondly, wave-soldering: It is critically important that all preheat stage and the solder bath temperatures are rigidly controlled.

### Non Lead-free Profile



### Lead-free Profile



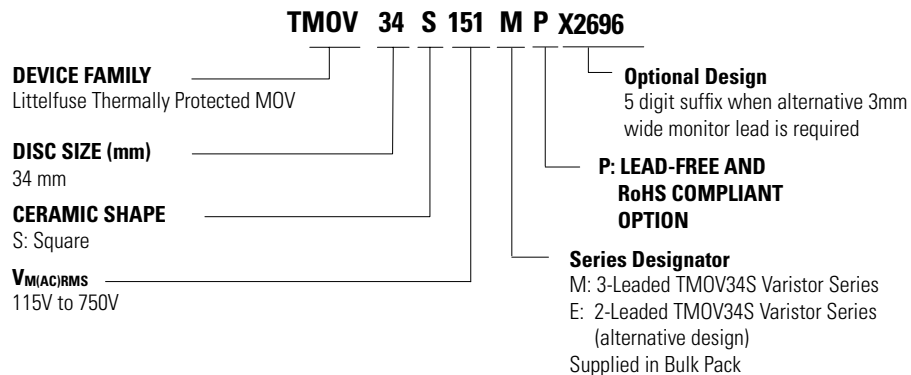
### Physical Specifications

<b>Lead Material</b>	Tin-plated Copper
<b>Soldering Characteristics</b>	Solderability per MIL-STD-202, Method 208
<b>Insulating Material</b>	Cured, flame retardant epoxy polymer meets UL94V-0 requirements.
<b>Device Labeling</b>	Marked with LF, part identifier, and date code

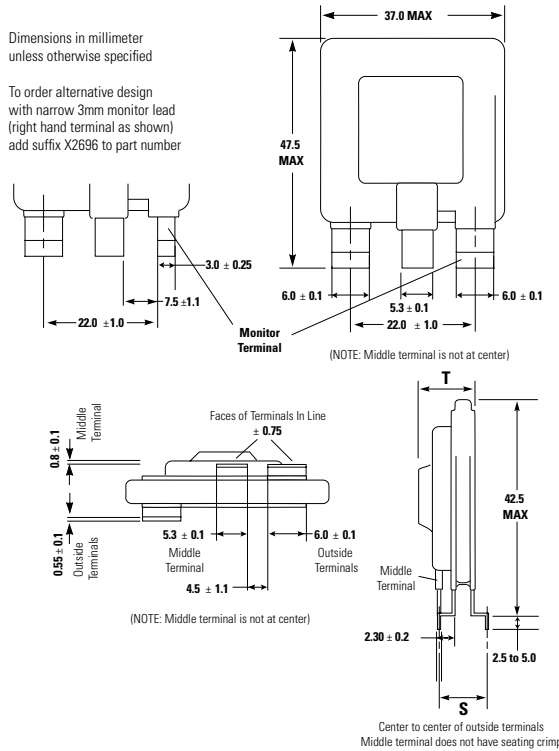
### Environmental Specifications

<b>Operating/Storage Temperature</b>	-55°C to +85°C/ -55°C to +125°C
<b>Humidity Aging</b>	+85°C, 85% RH, 1000 hours +/-10% voltage
<b>Thermal Shock</b>	+85°C to -40°C 5 times +/-10% voltage
<b>Solvent Resistance</b>	MIL-STD-202, Method 215
<b>Moisture Sensitivity</b>	Level 1, J-STD-020

### Part Numbering System

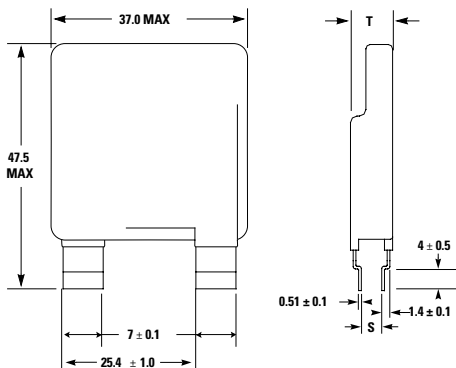


**Dimensions 3 Leaded Series**



Part Number	"T" Max Body Thickness	"S" Mounting Terminal Offset
TMOV34S111M(P)	11.90	5.2 -/+ .65
TMOV34S131M(P)	12.20	5.5 -/+ .65
TMOV34S141M(P)	12.30	5.7 -/+ 0.85
TMOV34S151M(P)	12.40	5.9 -/+ 0.85
TMOV34S181M(P)	12.80	6.3 -/+ 0.85
TMOV34S201M(P)	13.00	6.5 -/+ 0.85
TMOV34S251M(P)	12.75	6.25 -/+ 0.85
TMOV34S271M(P)	12.95	6.5 -/+ 0.85
TMOV34S301M(P)	13.30	6.8 -/+ 1.0
TMOV34S321M(P)	13.50	6.9 -/+ 1.0
TMOV34S331M(P)	13.60	7.2 -/+ 1.0
TMOV34S351M(P)	13.80	7.4 -/+ 1.0
TMOV34S391M(P)	14.20	7.6 -/+ 1.0
TMOV34S421M(P)	14.50	7.85 -/+ 1.0
TMOV34S461M(P)	14.75	8.15 -/+ 1.0
TMOV34S481M(P)	14.95	8.25 -/+ 1.0
TMOV34S511M(P)	15.40	8.6 -/+ 1.0
TMOV34S551M(P)	15.60	8.65 -/+ 1.0
TMOV34S571M(P)	15.90	8.85 -/+ 1.0
TMOV34S621M(P)	16.40	9.25 -/+ 1.0
TMOV34S661M(P)	16.85	9.65 -/+ 1.0
TMOV34S681M(P)	17.20	9.85 -/+ 1.0
TMOV34S751M(P)	17.80	10.65 -/+ 1.0

**Dimensions - Alternative 2 Leaded Series**



Part Number	T Dimension Max Body Thickness	S Dimension -- Mounting Terminal Offset
TMOV34S111EP	11.9	2.8 -/+ .65
TMOV34S131EP	12.2	2.9 -/+ .65
TMOV34S141EP	12.3	3.0 -/+0.85
TMOV34S151EP	12.4	3.1 -/+0.85
TMOV34S181EP	12.8	3.4 -/+0.85
TMOV34S201EP	13.0	3.6 -/+0.85
TMOV34S251EP	12.8	4.0 -/+0.85
TMOV34S271EP	13.0	4.3 -/+0.85
TMOV34S301EP	13.3	4.5 -/+1.0
TMOV34S321EP	13.5	4.7 -/+1.0
TMOV34S331EP	13.6	4.8 -/+1.0
TMOV34S351EP	13.8	5.0 -/+1.0
TMOV34S391EP	14.2	5.4 -/+1.0
TMOV34S421EP	14.5	5.7 -/+1.0
TMOV34S461EP	14.8	5.9 -/+1.0
TMOV34S481EP	15.0	6.1 -/+1.0
TMOV34S511EP	15.4	6.6 -/+1.0
TMOV34S551EP	15.6	6.8 -/+1.0
TMOV34S571EP	15.9	7.1 -/+1.0
TMOV34S621EP	16.4	7.5 -/+1.0
TMOV34S661EP	16.9	7.9 -/+1.0
TMOV34S681EP	17.2	8.2 -/+1.0
TMOV34S751EP	17.8	8.8 -/+1.0

**Disclaimer Notice** - Information furnished is believed to be accurate and reliable. However, users should independently evaluate the suitability of and test each product selected for their own applications. Littelfuse products are not designed for, and may not be used in, all applications. Read complete Disclaimer Notice at [www.littelfuse.com/disclaimer-electronics](http://www.littelfuse.com/disclaimer-electronics).