

TPSMF4L Series

Surface Mount – 400W



Additional Information



Resources



Accessories



Samples

Agency Approvals

Agency	Agency File Number
	E230531

Maximum Ratings and Thermal Characteristics ($T_A=25^\circ\text{C}$ unless otherwise noted)

Parameter	Symbol	Value	Unit
Peak Pulse Power Dissipation at $T_A=25^\circ\text{C}$ (Note 1)	P_{PPM}	2000 400	W W
Power Dissipation On Infinite Heat Sink at $T_L=50^\circ\text{C}$	P_D	1	W
Thermal Resistance Junction to Ambient	$R_{\theta JA}$	220	$^\circ\text{C/W}$
Thermal Resistance Junction to Lead	$R_{\theta JL}$	100	$^\circ\text{C/W}$
Operating and Storage Temperature Range	T_J, T_{STG}	-55 - 150	$^\circ\text{C}$

Notes:

1. Non-repetitive current pulse, per Fig. 4 and derated above T_J (initial) $=25^\circ\text{C}$ per Fig. 3.
2. TPSMF4L5.0A-TPSMF4L8.5A Peak Pulse Power Dissipation is 1850W min, 2000W typical @8/20us
3. TPSMF4L5.0A-TPSMF4L8.5A Peak Pulse Power Dissipation is 370W min, 400W typical @10/1000us

Functional Diagram

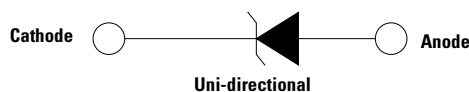

Description

The TPSMF4L series of SOD-123FL small and flat lead low-profile plastic package is designed specifically to protect sensitive electronic equipment from voltage transients induced by lightning and other transient voltage events, and it's especially suitable for high reliability and automotive application.

Features

- High reliability application and automotive grade AEC-Q101 qualified
- 400W peak pulsepower capability at 10/1000 μs waveform, repetition rate (duty cycle): 0.01 %
- Compatible with industrial standard package SOD-123FL
- Low inductance, excellent clamping capability
- For surface mounted applications to optimize board space
- Typical failure mode is short from over-specified voltage or current
- Whisker test is conducted based on JEDEC JESD201A per its table 4a and 4c
- IEC 61000-4-2 ESD 30kV(Air), 30kV (Contact)
- ESD protection of data lines in accordance with IEC 61000-4-2
- EFT protection of data lines in accordance with IEC 61000-4-4
- Fast response time: typically less than 1.0ns from 0 Volts to VBR min
- High temperature soldering: 260 $^\circ\text{C}$ /30 seconds at terminals
- $V_{BR} @ T_J = V_{BR} @ 25^\circ\text{C} \times (1 + \alpha T \times (T_J - 25))$
(αT : Temperature Coefficient, typical value is 0.1 %)
- Glass passivated junction
- Built-in strain relief
- Plastic package is flammability rated V-0 per Underwriters Laboratories
- Meet MSL level1, per J-STD-020, LF maximum peak of 260 $^\circ\text{C}$
- Matte tin lead-free plated
- Halogen-free and RoHS compliant
- Pb-free E3 means 2nd level interconnect is Pb-free and the terminal finish material is tin(Sn) (IPC/JEDEC J-STD-609A.01)
- UL Recognized as an Isolated Loop Circuit Protector per UL 497B

Applications

TPSMF4L devices are ideal for the protection of portable devices/ hard drives, notebooks, VCC busses, POS terminal, SSDs, power supplies, monitors, and vulnerable circuit used in other consumer applications.

TPSMF4L Series

Surface Mount – 400W

Electrical Characteristics ($T_A=25\text{ }^\circ\text{C}$ unless otherwise noted)

Part Number	Marking Code	Breakdown Voltage V_{BR} (Volts) @ I_T		Test Current I_T (mA)	Reverse Stand off Voltage V_R (V)	Maximum Reverse Leakage @ V_R, I_R (μA)	Maximum Peak Pulse Current I_{PP} (A)	Maximum Clamping Voltage @ I_{PP}, V_C (V)	Agency Approval
		Min	Max						
TPSMF4L5.0A	KEA	6.40	7.00	10	5.0	800	40.1	9.2	X
TPSMF4L6.0A	KGA	6.67	7.37	10	6.0	800	35.9	10.3	X
TPSMF4L6.5A	KKA	7.22	7.98	10	6.5	500	33.1	11.2	X
TPSMF4L7.0A	KMA	7.78	8.60	10	7.0	200	30.9	12.0	X
TPSMF4L7.5A	KPA	8.33	9.21	1	7.5	100	28.7	12.9	X
TPSMF4L8.0A	KRA	8.89	9.83	1	8.0	50	27.2	13.6	X
TPSMF4L8.5A	KTA	9.44	10.40	1	8.5	20	25.7	14.4	X
TPSMF4L9.0A	KVA	10.00	11.10	1	9.0	5	26.4	15.4	X
TPSMF4L10A	KXA	11.10	12.30	1	10	5	23.5	17.0	X
TPSMF4L11A	KZA	12.20	13.50	1	11	1	22.0	18.2	X
TPSMF4L12A	LEA	13.30	14.70	1	12	1	20.1	19.9	X
TPSMF4L13A	LGA	14.40	15.90	1	13	1	18.6	21.5	X
TPSMF4L14A	LKA	15.60	17.20	1	14	1	17.2	23.2	X
TPSMF4L15A	LMA	16.70	18.50	1	15	1	16.4	24.4	X
TPSMF4L16A	LPA	17.80	19.70	1	16	1	15.4	26.0	X
TPSMF4L17A	LRA	18.90	20.90	1	17	1	14.5	27.6	X
TPSMF4L18A	LTA	20.00	22.10	1	18	1	13.7	29.2	X
TPSMF4L20A	LVA	22.20	24.50	1	20	1	12.3	32.4	X
TPSMF4L22A	LXA	24.40	26.90	1	22	1	11.3	35.5	X
TPSMF4L24A	LZA	26.70	29.50	1	24	1	10.3	38.9	X
TPSMF4L26A	MEA	28.90	31.90	1	26	1	9.5	42.1	X
TPSMF4L28A	MGA	31.10	34.40	1	28	1	8.8	45.4	X
TPSMF4L30A	MKA	33.30	36.80	1	30	1	8.3	48.4	X
TPSMF4L33A	MMA	36.70	40.60	1	33	1	7.5	53.3	X
TPSMF4L36A	MPA	40.00	44.20	1	36	1	6.9	58.1	X
TPSMF4L40A	MRA	44.40	49.10	1	40	1	6.2	64.5	X
TPSMF4L43A	MTA	47.80	52.80	1	43	1	5.8	69.4	X
TPSMF4L45A	MVA	50.00	55.30	1	45	1	5.5	72.7	X
TPSMF4L48A	MXA	53.30	58.90	1	48	1	5.2	77.4	X
TPSMF4L51A	MZA	56.70	62.70	1	51	1	4.9	82.4	X
TPSMF4L54A	NEA	60.00	66.30	1	54	1	4.6	87.1	X
TPSMF4L58A	NGA	64.40	71.20	1	58	1	4.3	93.6	X
TPSMF4L60A	NKA	66.70	73.70	1	60	1	4.1	96.8	X
TPSMF4L64A	NMA	71.10	78.60	1	64	1	3.9	103.0	X
TPSMF4L70A	NPA	77.80	86.00	1	70	1	3.5	113.0	X
TPSMF4L75A	NRA	83.30	92.10	1	75	1	3.3	121.0	X
TPSMF4L78A	NTA	86.70	95.80	1	78	1	3.2	126.0	X
TPSMF4L85A	NVA	94.40	104.00	1	85	1	2.9	137.0	X

Notes:

- V_{BR} measured after I_T applied for 300 μs . I_T = square wave pulse or equivalent.
- Surge current waveform per 10/1000 μs exponential wave and derated per Fig.3.
- All terms and symbols are consistent with ANSI/IEEE C62.35.

TPSMF4L Series

Surface Mount – 400W

I-V Curve Characteristics

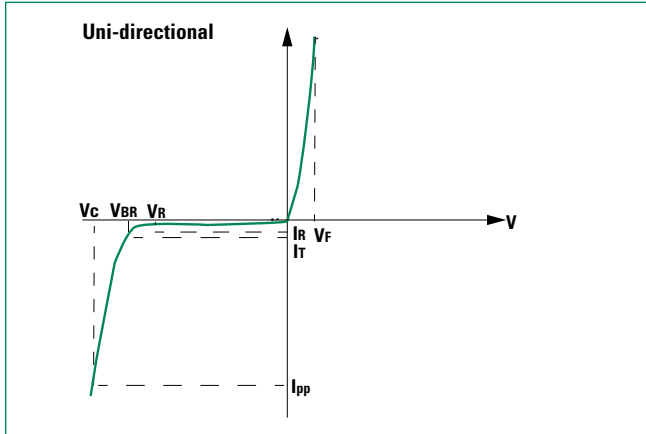

- P_{PPM} **Peak Pulse Power Dissipation** – Max power dissipation
- V_R **Stand-off Voltage** – Maximum voltage that can be applied to the TVS without operation
- V_{BR} **Breakdown Voltage** – Maximum voltage that flows through the TVS at a specified test current (I_r)
- V_C **Clamping Voltage** – Peak voltage measured across the TVS at a specified I_{ppm} (peak impulse current)
- I_r **Reverse Leakage Current** – Current measured at V_R
- V_f **Forward Voltage Drop for Uni-directional**

Ratings and Characteristic Curves ($T_A=25\text{ }^\circ\text{C}$ unless otherwise noted)

Figure 1 -
TVS Transients Clamping Waveform

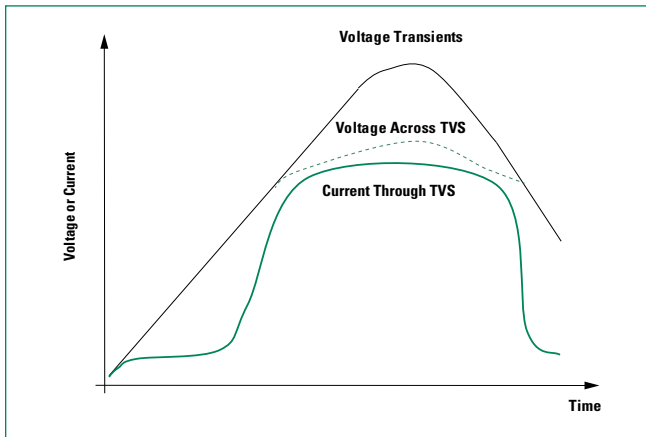
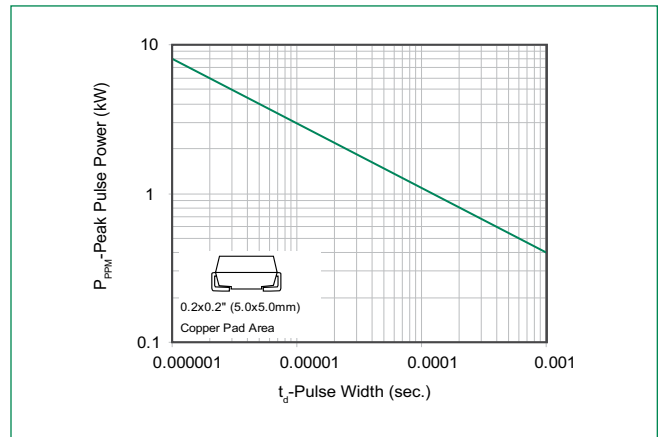

Figure 2 -
Peak Pulse Power Rating Curve



TPSMF4L Series

Surface Mount – 400W

Ratings and Characteristic Curves ($T_A=25^\circ\text{C}$ unless otherwise noted) (Continued)

Figure 3 -
Peak Pulse Power Derating Curve

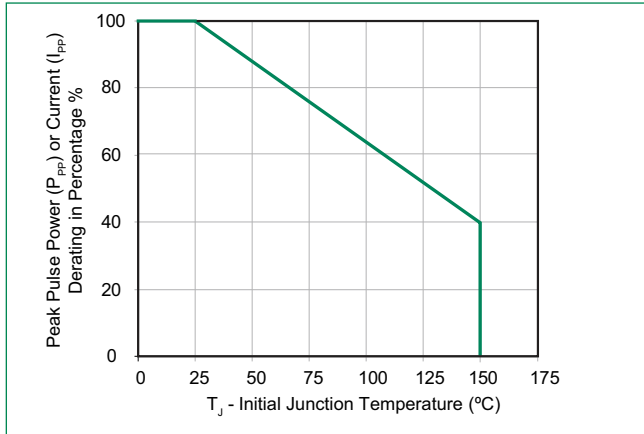

Figure 4 -
Pulse Waveform - 10/1000 μs

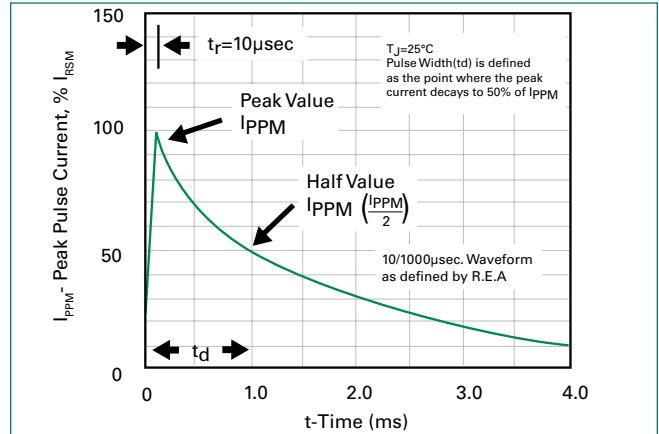

Figure 5 -
Forward Voltage

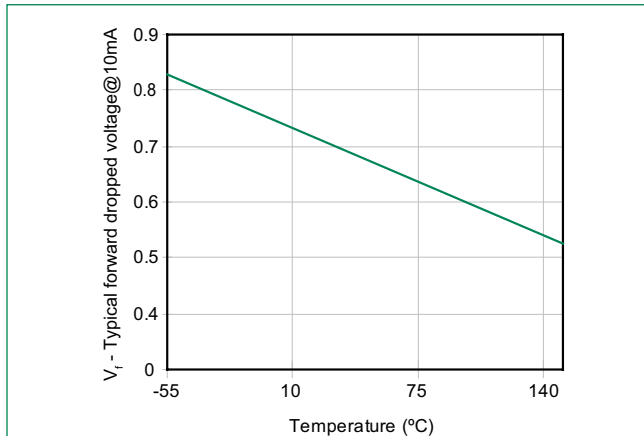

Figure 6 -
Typical Junction Capacitance

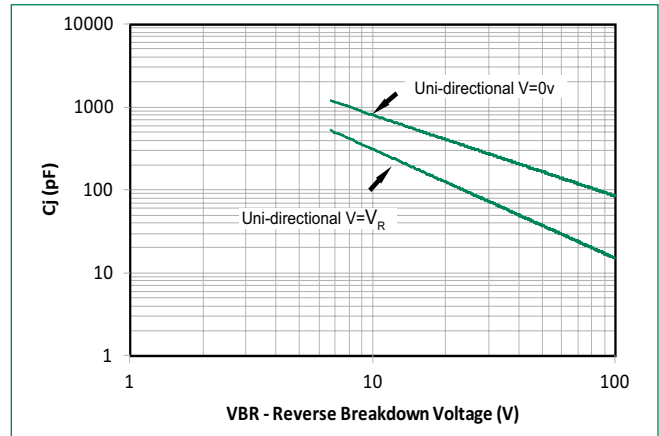

Figure 7 -
Peak Forward Voltage Drop vs. Peak Forward Current

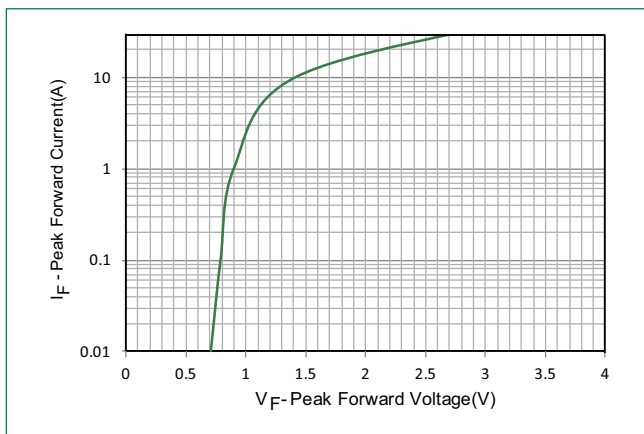
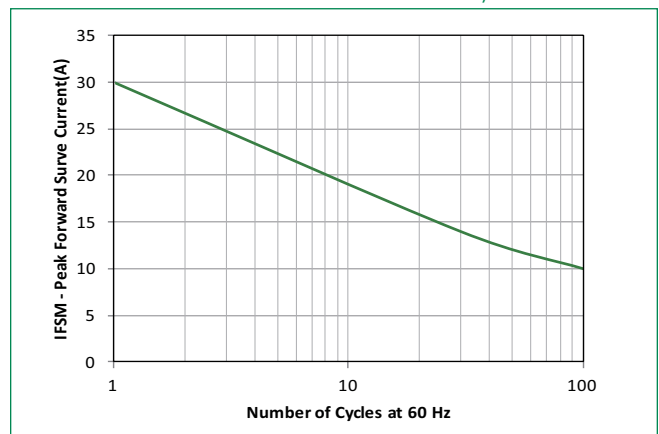

Figure 8 -
Maximum Non-Repetitive Forward Surge Current Uni-Directional Only



TPSMF4L Series

Surface Mount – 400W

Soldering Parameters

Reflow Condition		Lead-free assembly
Pre Heat	- Temperature Min ($T_{s(min)}$)	150°C
	- Temperature Max ($T_{s(max)}$)	200°C
	- Time (min to max) (t_s)	60 – 120 secs
Average ramp up rate (Liquidus Temp (T_L) to peak)		3°C/second Max
$T_{s(max)}$ to T_L - Ramp-up Rate		3°C/second Max
Reflow	- Temperature (T_L) (Liquidus)	217°C
	- Time (min to max) (t_L)	60 – 150 seconds
Peak Temperature (T_p)		260 ^{+0/-5} °C
Time within 5°C of actual peak Temperature (t_p)		30 seconds Max
Ramp-down Rate		6°C/second Max
Time 25°C to peak Temperature (T_p)		8 minutes Max.
Do not exceed		260°C

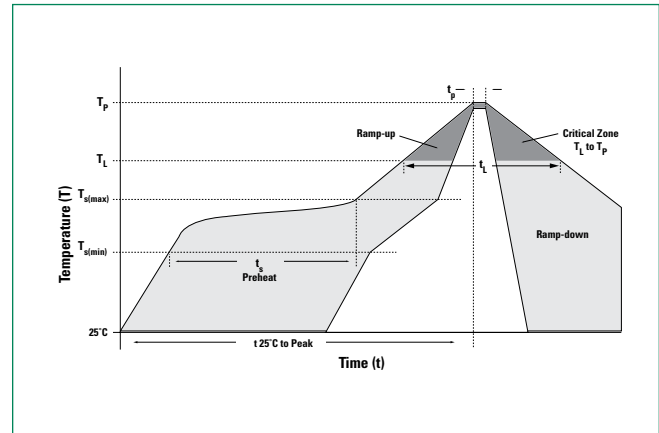

Physical Specifications

Case	SOD-123FL plastic over glass passivated junction
Polarity	Color band denotes cathode except bipolar
Terminal	Matte tin-plated leads, solderable per JESD22-B102

Environmental Specifications

High Temp. Storage	JESD22-A103
HTRB	JESD22-A108
Temperature Cycling	JESD22-A104
MSL	JEDEC-J-STD-020, Level 1
H3TRB	JESD22-A101
RSH	JESD22-A111

Dimensions - SOD-123FL Package

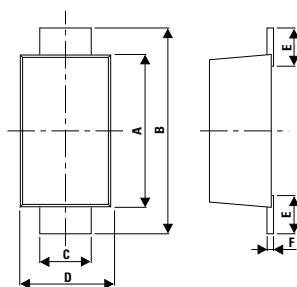

Mounting Pad Layout

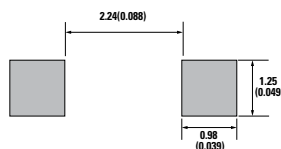

Dimensions	Millimeters		Inches	
	Min	Max	Min	Max
A	2.90	3.10	0.114	0.122
B	3.50	3.90	0.138	0.154
C	0.85	1.05	0.033	0.041
D	1.70	2.00	0.067	0.079
E	0.43	0.83	0.017	0.033
F	0.10	0.25	0.004	0.010
G	0.00	0.10	0.000	0.004
H	0.90	1.08	0.035	0.043

TPSMF4L Series

Surface Mount – 400W

Part Numbering System

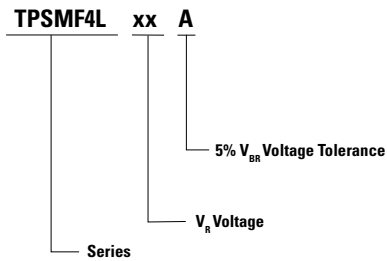

Part Marking System

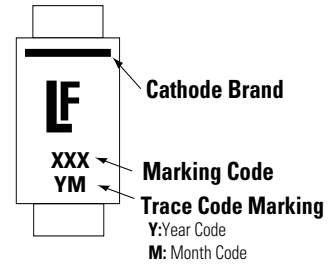

Packaging Options

Part number	Component Package	Quantity	Packaging Option	Packaging Specification
TPSMF4LXXX	SOD-123FL	3000	Tape & Reel – 8mm tape/7" reel	EIA RS-481

Tape and Reel Specification

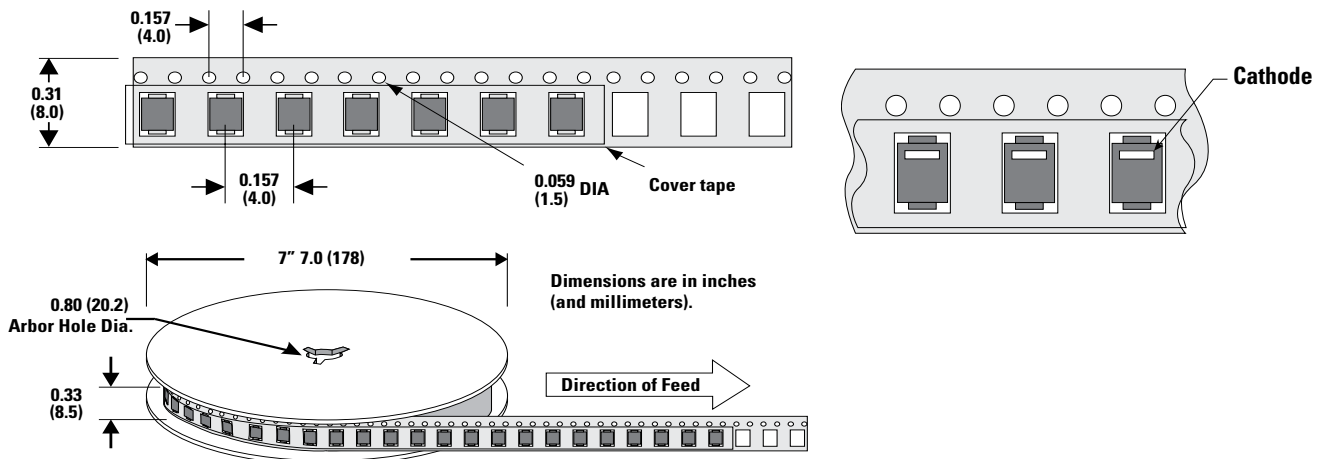

Disclaimer Notice - Information furnished is believed to be accurate and reliable. However, users should independently evaluate the suitability of and test each product selected for their own applications. Littelfuse products are not designed for, and may not be used in, all applications. Read complete Disclaimer Notice at <http://www.littelfuse.com/disclaimer-electronics>.