

SLD6S Series

Surface Mount

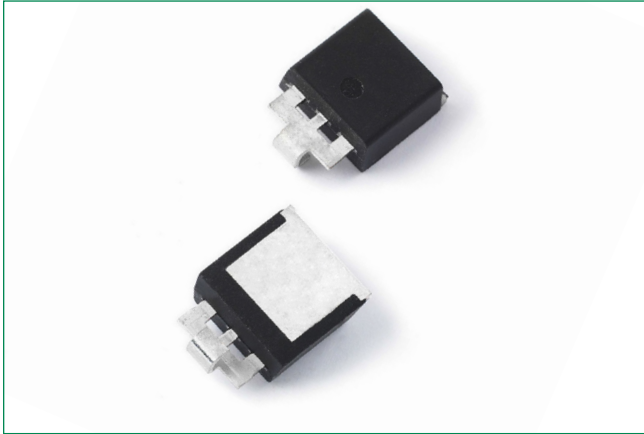

Agency Approvals

Agency	Agency File Number
	E230531

Maximum Ratings and Thermal Characteristics

($T_A=25^\circ\text{C}$ unless otherwise noted)

Parameter	Symbol	Value	Unit
Peak Pulse Power Dissipation 1. 10ms / 150ms test waveform 2. 10 μs /1000 μs test waveform	P_{PPM}	1800 4600	W
Power dissipation on infinite heatsink at $T_A=25^\circ\text{C}$	P_D	6	W
Maximum Instantaneous Forward Voltage at 100A for Unidirectional only	V_F	1.8	V
Peak forward surge current 8.3ms single half sine-wave	I_{FSM}	800	A
Operating Junction and Storage Temperature Range	T_J, T_{STG}	-55 to 150	$^\circ\text{C}$
Typical Thermal Resistance Junction to case	$R_{\theta JC}$	1.1	$^\circ\text{C}/\text{W}$
Typical Thermal Resistance Junction to Ambient	$R_{\theta JA}$	12.3	$^\circ\text{C}/\text{W}$



Description

The SLD6S unidirectional TVS Diode series is housed in a SMTO-263 package with lead modifications. It is designed to protect sensitive electronics against ESD, EFT, 10/1000 surge events and inductive load switching voltage transient events for severe Automotive Load Dump applications.

Features

- AEC-Q101 qualified with automotive grade (PPAP capable)
- SMTO-263 package, and foot print is compatible to industrial popular DO-218AB package
- Meet ISO7637-2 5a/5b protection, ISO16750 and JASO D-001 load dump test (refer to APP note for details)
- $V_{BR} @ T_J = V_{BR} @ 25^\circ\text{C} \times (1 + \alpha T \times (T_J - 25))$ (α : Temperature Coefficient, typical value is 0.1%)
- Glass passivated chip junction in modified TO-263 package
- ESD protection of data lines in accordance with IEC 61000-4-2, 30kV(Air), 30kV (Contact)
- EFT protection of data lines in accordance with IEC 61000-4-4
- Fast response time: typically less than 1.0ps from 0 Volts to V_{BR} min
- Excellent clamping capability
- Low incremental surge resistance
- UL Recognized compound meeting flammability rating V-0
- Meets MSL level 1, per J-STD-020, High temperature reflow soldering guaranteed: 260 $^\circ\text{C}$ /10sec at terminals
- For surface mounted applications to optimize board space
- Low profile package
- Matte tin lead-free plated
- Halogen free and RoHS compliant
- Pb-free E3 means 2nd level interconnect is Pb-free and the terminal finish material is tin (Sn) (IPC/JEDEC J-STD-609A.01)

Applications

Designed to protect sensitive electronics from:

- Inductive Load Switching
- Alternator Load Dump

Functional Diagram



SLD6S Series

Surface Mount

Electrical Characteristics ($T_A=25^\circ\text{C}$ unless otherwise noted)

Part Number (Uni)	Breakdown Voltage V_{BR} @ I_T (V)		Test Current I_T (mA)	Reverse Stand off Voltage V_R (Volts)	Maximum Reverse Leakage I_R @ V_R (μA)	$T_J=150^\circ\text{C}$ Max. Reverse Leakage I_R @ V_R (μA)	Maximum Peak Pulse Surge Current I_{PP} (A)	Maximum Clamping Voltage V_C @ I_{PP} (V)	Agency Approval
	MIN	MAX							
SLD6S14A	15.6	17.2	5.0	14	10	50	198	23.2	x
SLD6S15A	16.7	18.5	5.0	15	10	50	189	24.4	x
SLD6S16A	17.8	19.7	5.0	16	2.0	50	177	26.0	x
SLD6S17A	18.9	20.9	5.0	17	2.0	50	167	27.6	x
SLD6S18A	20.0	22.1	5.0	18	2.0	50	158	29.2	x
SLD6S20A	22.2	24.5	5.0	20	2.0	50	142	32.4	x
SLD6S22A	24.4	26.9	5.0	22	2.0	50	130	35.5	x
SLD6S24A	26.7	29.5	5.0	24	2.0	50	118	38.9	x
SLD6S26A	28.9	31.9	5.0	26	2.0	50	109	42.1	x
SLD6S27A	29.9	33.1	5.0	27	2.0	50	106	43.6	x
SLD6S28A	31.1	34.4	5.0	28	2.0	50	101	45.4	x
SLD6S30A	33.3	36.8	5.0	30	2.0	50	95	48.4	x
SLD6S33A	36.7	40.6	5.0	33	2.0	50	86	53.3	x
SLD6S36A	40.0	44.2	5.0	36	2.0	50	79	58.1	x
SLD6S40A	44.4	49.1	5.0	40	2.0	50	71	64.5	x
SLD6S43A	47.8	52.8	5.0	43	2.0	50	66	69.4	x
SLD6S48A	53.3	58.9	5.0	48	2.0	50	59	77.4	x
SLD6S57A	63.8	69.9	5.0	57	2.0	50	50	92.7	x

Notes:

- V_{BR} measured after I_T applied for 300 μs , I_T = square wave pulse or equivalent.
- Surge current waveform per 10 μs /1000 μs exponential wave and derated per Fig. 2
- All terms and symbols are consistent with ANSI/IEEE C62.35.

Load Dump Test Wave Form

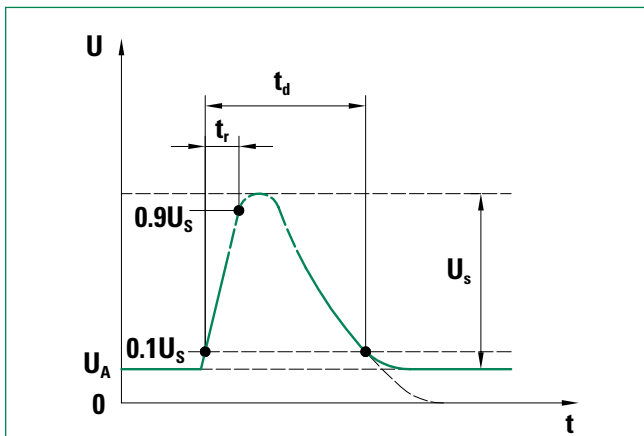

Note: LF use $t_d=400\text{ms}$ for 12V system test; $t_d=350\text{ms}$ for 24V system

Parameter	12V system	24V system
U_s	65v to 87V	123V to 174V
R_i	0.5 Ω to 4 Ω	1 Ω to 8 Ω
t_d	40 ms to 400 ms	100 ms to 350 m
t_r	$(10^{0.5})\text{ms}$	

SLD6S Series

Surface Mount

I-V Curve Characteristics

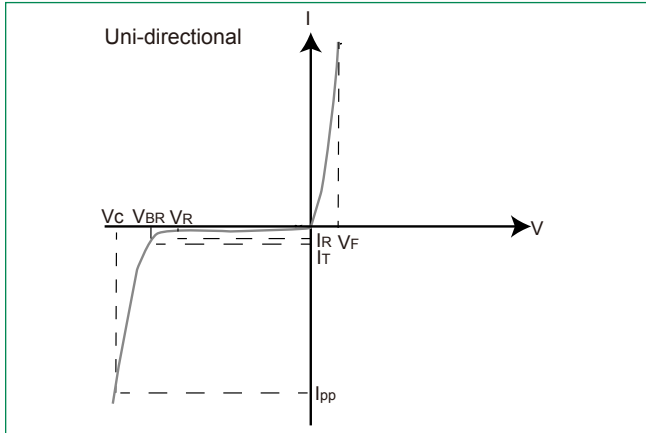

P_{PPM} - Peak Pulse Power Dissipation – Max power dissipation
 V_R - Stand-off Voltage – Maximum voltage that can be applied to the TVS without operation
 V_{BR} - Breakdown Voltage – Maximum voltage that flows though the TVS at a specified test current (I_T)
 V_C - Clamping Voltage – Peak voltage measured across the TVS at a specified I_{PPM} (peak impulse current)
 I_R - Reverse Leakage Current – Current measured at V_R
 V_F - Forward Voltage Drop for Uni-directional

Ratings and Characteristic Curves ($T_A=25^\circ\text{C}$ unless otherwise noted)

Figure 1 - Peak Pulse Power Rating Curve

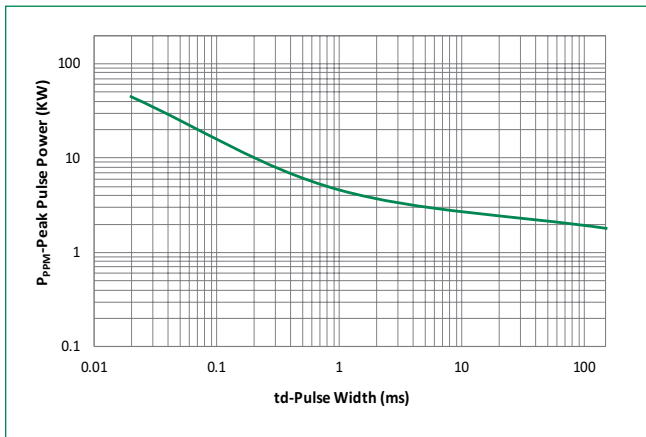

Figure 2 - Peak Pulse Power Derating Curve

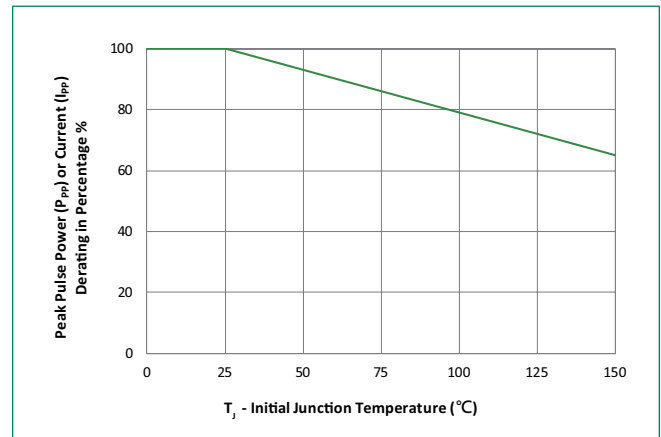

Figure 3 - Typical Transient Thermal Impedance

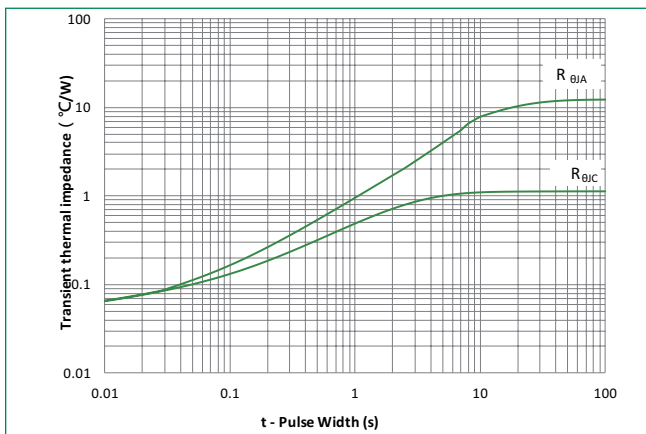
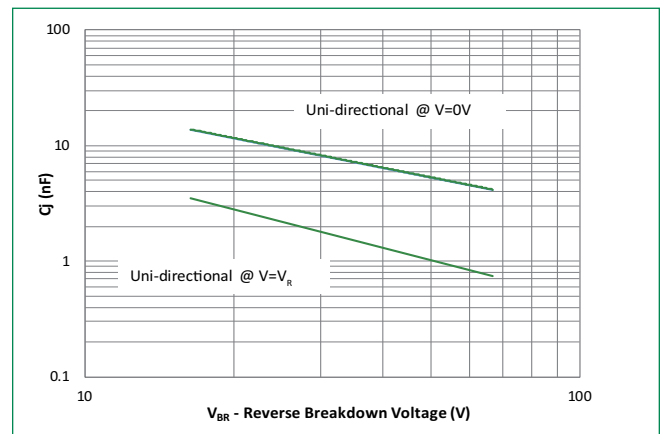

Figure 4 - Typical Junction Capacitance



SLD6S Series

Surface Mount

Figure 5 - Typical SOA Chart

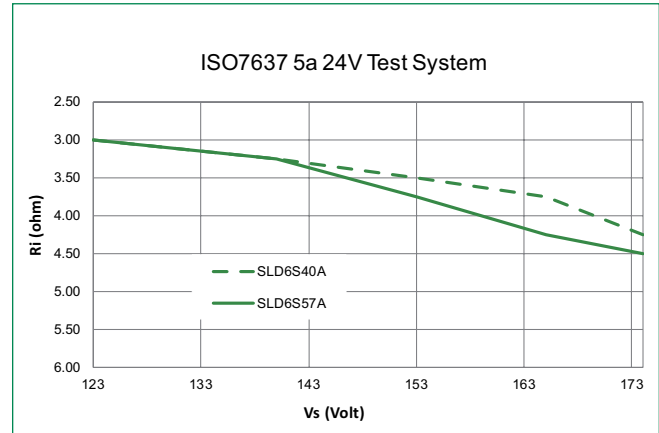
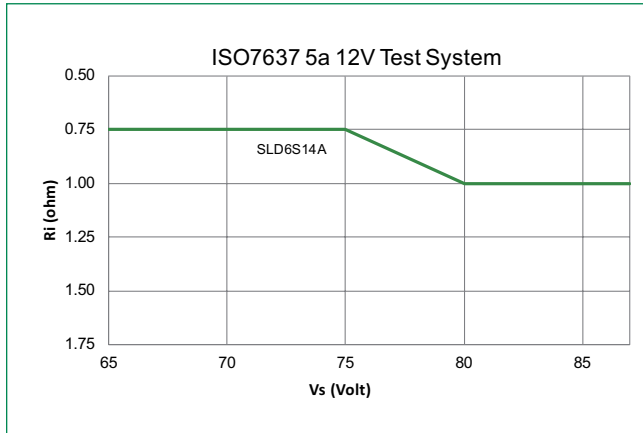

Note: SOA (Safe Operation Area) refer to the area which below the curve line and refer to APP note for details.

Soldering Parameters

Reflow Condition		Lead-free assembly
Pre Heat	- Temperature Min ($T_{s(min)}$)	150°C
	- Temperature Max ($T_{s(max)}$)	200°C
	- Time (min to max) (t_s)	60 – 120 secs
Average ramp up rate (Liquidus Temp (T_L) to peak)		3°C/second max
$T_{s(max)}$ to T_L - Ramp-up Rate		3°C/second max
Reflow	- Temperature (T_L) (Liquidus)	217°C
	- Time (min to max) (t_L)	60 – 150 seconds
Peak Temperature (T_p)		260 ^{+0/-5} °C
Time within 5°C of actual peak Temperature (t_p)		30 seconds max
Ramp-down Rate		6°C/second max
Time 25°C to peak Temperature (T_p)		8 minutes max.
Do not exceed		260°C

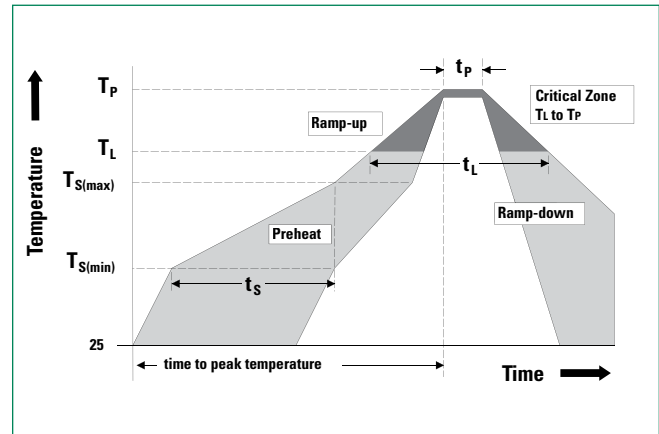

SLD6S Series

Surface Mount

Physical Specifications

Terminal Finish	100% Matte Tin-plated
Body Material	UL Recognized compound meeting flammability classification 94V-0
Lead Material	Copper Alloy

Environmental Specifications

High Temp. Storage	JESD22-A103
HTRB	JESD22-A108
Temperature Cycling	JESD22-A104
MSL	JEDEC-J-STD-020, LEVEL 1
H3TRB	JESD22-A101
RSH	JESD22-A111

Dimensions

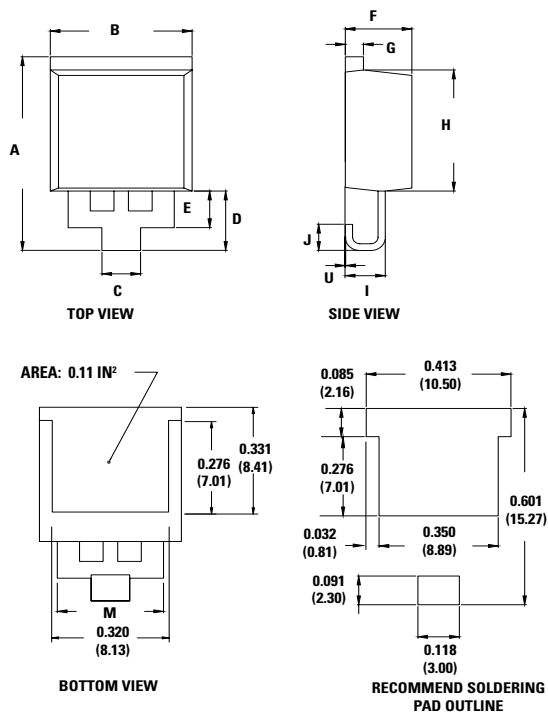

Dimensions	Inches		Millimeters	
	Min	Max	Min	Max
A	0.568	0.600	14.44	15.24
B	0.380	0.420	9.65	10.67
C	0.098	0.114	2.50	2.90
D	0.169	0.189	4.30	4.80
E	0.102	0.118	2.60	3.00
F	0.178	0.188	4.52	4.78
G	0.045	0.060	1.14	1.52
H	0.360	0.370	9.14	9.40
I	0.106	0.122	2.69	3.09
J	0.069	0.089	1.75	2.25
M	0.284	0.300	7.22	7.62
U	0	0.010	0	0.25

SLD6S Series

Surface Mount

Part Numbering System

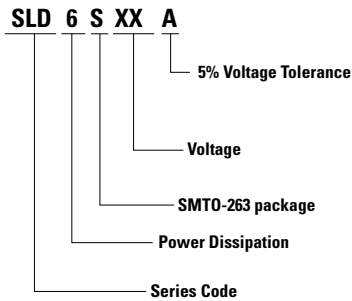

Part Marking System

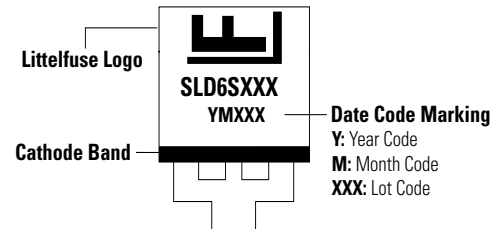

Packaging

Part Number	Component Package	Quantity	Packaging Option
SLD6SxxA	SMT0-263	500	Embossed Carrier

SMT0-263 Embossed Carrier Reel Pack (RP) Specifications

Meets all EIA-481-2 Standards

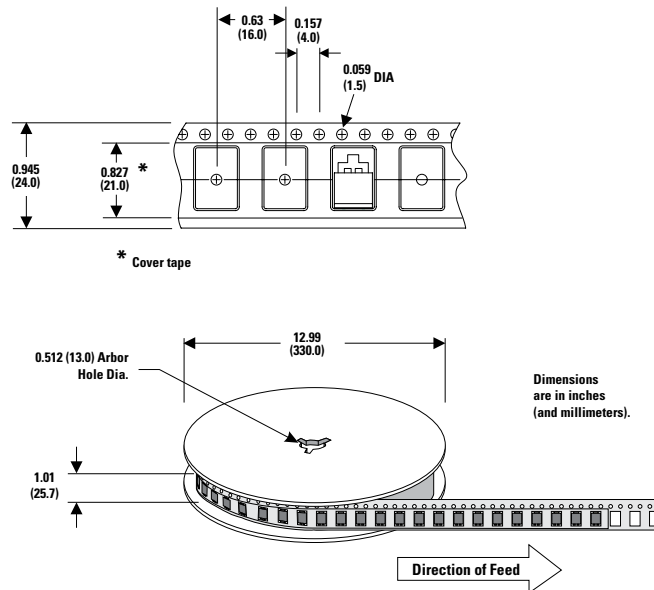

Product Disclaimer: Littelfuse products are not designed for, and shall not be used for, any purpose (including, without limitation, automotive, military, aerospace, medical, life-saving, life-sustaining or nuclear facility applications, devices intended for surgical implant into the body, or any other application in which the failure or lack of desired operation of the product may result in personal injury, death, or property damage) other than those expressly set forth in applicable Littelfuse product documentation. Warranties granted by Littelfuse shall be deemed void for products used for any purpose not expressly set forth in applicable Littelfuse documentation. Littelfuse shall not be liable for any claims or damages arising out of products used in applications not expressly intended by Littelfuse as set forth in applicable Littelfuse documentation. The sale and use of Littelfuse products is subject to Littelfuse Terms and Conditions of Sale, unless otherwise agreed by Littelfuse. "Littelfuse" includes Littelfuse, Inc., and all of its affiliate entities. <http://www.littelfuse.com/disclaimer-electronics>.