

Automotive Circuit Protection using Littelfuse Automotive TVS Diodes



The Challenge

The designers of automotive electronics face many technical challenges during the system design process, including designing methods of protection against a variety of electrical hazards. The three major sources of electrical hazards in these systems are electrostatic discharge (ESD), lightning, and switching loads in power electronics circuits. Overcoming transient surges that can harm the vehicle's electronics is one of the biggest challenges of the design process.

The Solution

Protecting automotive electronics includes eliminating transient surges that can damage the control units, infotainment electronics, sensors, fuel injectors, valves, motors, 12/24/42/48V powertrains and hydrolytic controllers, etc.

Note: For 48V power system with high power surge rating, welcome to contact Littelfuse for technical support and application test!

What do Littelfuse Transient Voltage Suppression (TVS) diodes protect?

As shown in Figure 1, Littelfuse TVS diodes provide protection for four main categories of vehicle systems: safety, performance and emissions, comfort and convenience, and hybrid vehicles.

In modern automotive designs, all on-board electronics are connected to the battery and the alternator. As indicated in Figure 2, the output of the alternator is unstable and requires further conditioning before it can be used to power the vehicle's other systems. Currently, most of the alternators have zener diodes to protect against load dump surges; however, these are still not sufficient. During the powering or switching of inductive loads, the battery is disconnected, so that unwanted spikes or transients are generated. If left uncorrected, these transients would be transmitted along the power line, causing individual electronics and sensors to malfunction or permanently damaging the vehicle's electronic system, affecting overall reliability.

Figure 1. Vehicle systems subject to transient surge hazards

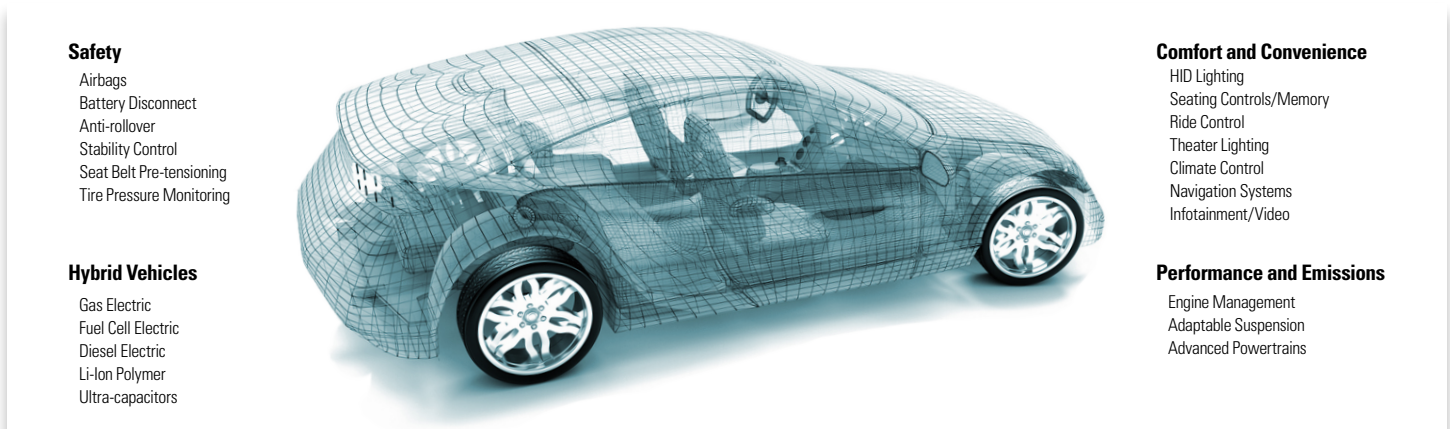

Automotive Transient Surge (Not ESD) Standard

Littelfuse is a leading provider of [TPSMF4L](#), [TPSMB](#), [TPSMA6L](#), [TPSMC](#), [TPSMD](#), [TP6KE](#), [TP1.5KE](#), [TP5KP](#), [SZSMF](#), [SZSMF4L](#), [SZ1SMA](#), [SZ1SMB](#), [SZP6SMB](#), [SZ1SMC](#), [SZ1.5SMC](#), [SLD](#), [SLD5S](#), [SLD6S](#) and [SLD8S Series](#) TVS Diodes which can provide secondary transient voltage protection for sensitive electronics from transients induced by load dump and other transient voltage events. These series offer superior electrical performance in a small footprint package, allowing designers to upgrade their circuit protection without altering their existing design footprint or to provide more robust protection in new circuit layouts.

Load dump protection requires high energy TVS diodes in a 12V/24V system. For more information on load dump protection, visit [Littelfuse.com](#).

The automotive market has major two standards that outline protection against transient surges: JASO and ISO7637-2 (Surge) test for the Japanese, American, and international markets. JASO A-1 outlines test conditions for 14V vehicle systems; JASO D-1 outlines test conditions for 27V vehicles.

The following test standards are international and American test standards, which include the load dump, switching transients and ESD threats.

Figure 2. The alternator causes most of the transients in a vehicle's electrical system.

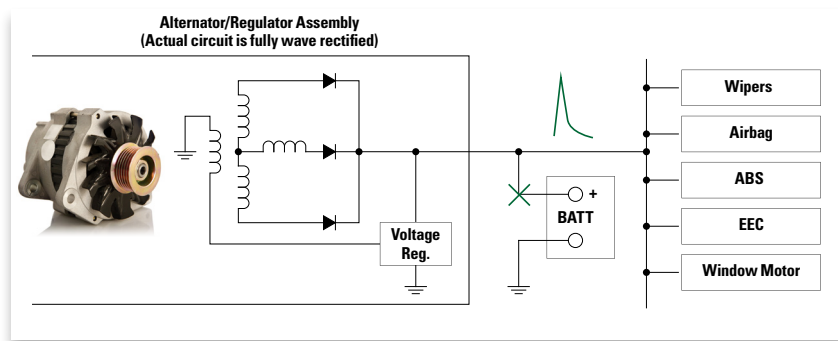

International Standard ISO7637-2:

- Applies to road vehicles-electrical disturbance by conduction and coupling

More Information on the ISO7637-2 Pulses:

- Automotive EMC Transition Requirements
 - Pulse 1- Interruption of inductive load – refers to disconnection of the power supply from an inductive load while the device under test (DUT) is in parallel with the inductive load
 - Pulse 2a - Interruption of series inductive load – refers to the interruption of current and causes load switching
 - Pulse 3 - Switching spikes
 - 3a negative transient burst
 - 3b positive transient burst

USA National Standard:

- SAE (Society of Automotive Engineers) J1113
- GM 9105, ES-F2af-1316-AA Ford (Visteon)

- Refers to the unwanted transients in the switching events
- Pulse 4 - Starter crank – refers battery voltage drop during motor start. This always happens in cold weather
- Pulse 5 - Load dump – refers to the disconnection of the vehicle battery from the alternator while the battery is being charged.
- Pulse 6 - Ignition coil interruption
- Pulse 7 - Alternator field decay
- Pulse 1, 2a, 3a, 3b, 5 - Related to high voltage transient getting into the supply line; Pulse 4 defines minimum battery voltage. Refer to Figure 3a and Table 1

Figure 3a. Surge wave of different pulses and its magnitude

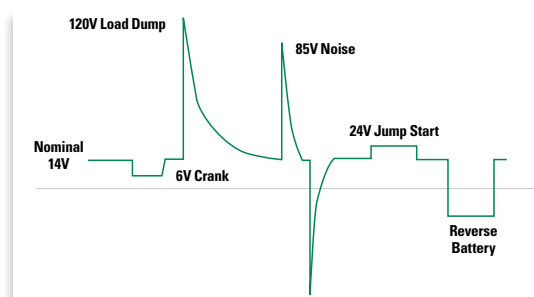

Automotive Environment Test Levels

Table 1. ISO7637-2 test levels on each pulse (12V)

Test Pulse	Test Levels (12V System)				Min. No. of Pulses or Test Time
	I Min.	II	III	IV Max.	
1	-	-	-75V	-100V	5000 pulses
2a	-	-	+37V	+112V	5000 pulses
2b	-	-	+10V	+10V	10 pulses
3a	-	-	-112V	-220V	1 hour
3b	-	-	+75V	+150V	1 hour
5a	-	-	+65V	+87V	1 pulse
5b	-	-	+65V	+87V	1 pulse

Table 2. ISO7637-2 test levels on each pulse (24V)

Test Pulse	Test Levels (24V System)				Min. No. of Pulses or Test Time
	I Min.	II	III	IV Max.	
1	-	-	-300V	-600V	5000 pulses
2a	-	-	+37V	+112V	5000 pulses
2b	-	-	+20V	+20V	10 pulses
3a	-	-	-150V	-300V	1 hour
3b	-	-	+150V	+300V	1 hour
5a	-	-	+123V	+173V	1 pulse
5b	-	-	+123V	173V	1 pulse

- Pulse 1 is a transient caused by battery supply disconnection from inductive loads.
- Pulse 2a simulates transients due to sudden interruption of currents in a device connected in parallel with the DUT due to the inductance of the wiring harness.
- Pulse 2b simulates transients from DC motors acting as generators after the ignition is switched off.
- Pulse 3a and 3b are switching transients.
- Pulse 5a and 5b are load dump transients. 5b clamp voltage U_s^* is defined by different car manufacturers.
- The former levels I and II were deleted because they do not ensure sufficient immunity in road vehicles.
- Four performance levels for each pulse
- Different o/c voltage
- Negative and positive
- Pulse duration 0.1–400ms
- Single and burst
- TVS protection and its operation mode

Results of Littelfuse Automotive TVS Diode in ISO7637-2 Surge Test

Table 1a and 1b summarizes the compliance of each level of the ISO7637-2 surge test in 12V and 24V power systems when using various Littelfuse Automotive TVS Diode series. Series [TPSMF4L](#), [TPSMA6L](#), [TPSMB](#), [TP6KE](#), [TPSMC](#), [TPSMD](#), [SZSMF](#), [SZSMF4L](#), [SZ1SMA](#), [SZ1SMB](#), [SZP6SMB](#), [SZ1SMC](#) and [SZ1.5SMC](#) feature pulse power ratings from 400W to 3000W. [TP6KE](#) series is a through-hole TVS while the rest are surface mount. These devices help the power system pass the different surge tests (1, 2a, 2b, 3a, 3b, 5a and 5b) operationally as specified by ISO7637-2. Referred to the table 12v system below, only if the alternator R_i value is higher than 4.5Ω , [TPSMD](#) series TVS can then be used to pass the higher energy 5a surge. If R_i value (Alternator internal resistance) is lower than 4.5Ω , then the higher power TVS such as [SLD](#), [SLD5S](#), [SLD6S](#) or [SLD8S](#) series are suggested used for such design. For the 24V car power system surge compliance, refer to the 24V system results below.

Table 1a. Littelfuse Automotive TVS Diode series compliance with various surge levels in 12V powertrains

TVS Series	12V System											
	Level 3						Level 4					
	1	2a	2b	3a	3b	5a	1	2a	2b	3a	3b	5a
	-75V	+37V	+10V	-112V	+75V	+65V	-100V	+112V	+10V	-220V	+150V	+87V
SZSMF	Pass	Pass	Pass	Pass	Pass	-	Pass	Pass	Pass	Pass	Pass	-
SZSMF4L/ SZSMF	Pass	Pass	Pass	Pass	Pass	-	Pass	Pass	Pass	Pass	Pass	-
TPSMA6L/ SZ1SMA	Pass	Pass	Pass	Pass	Pass	-	Pass	Pass	Pass	Pass	Pass	-
TPSMB/ SZ1SMB / SZP6SMB	Pass	Pass	Pass	Pass	Pass	-	Pass	Pass	Pass	Pass	Pass	-
TPSMC/ SZ1SMC / SZ1.5SMC	Pass	Pass	Pass	Pass	Pass	-	Pass	Pass	Pass	Pass	Pass	-
TPSMD	Pass	Pass	Pass	Pass	Pass	-	Pass	Pass	Pass	Pass	Pass	-
TP5.0SMD/ SZ5KASMC	Pass	Pass	Pass	Pass	Pass	-	Pass	Pass	Pass	Pass	Pass	-
TP6KE	Pass	Pass	Pass	Pass	Pass	-	Pass	Pass	Pass	Pass	Pass	-
TP1.5KE	Pass	Pass	Pass	Pass	Pass	-	Pass	Pass	Pass	Pass	Pass	-
TP5KP	Pass	Pass	Pass	Pass	Pass	-	Pass	Pass	Pass	Pass	Pass	-
SLD	Pass	Pass	Pass	Pass	Pass	Conditional Pass	Pass	Pass	Pass	Pass	Pass	Conditional Pass
SLD5S/SLD6S/SLD8S	Pass	Pass	Pass	Pass	Pass	Conditional Pass	Pass	Pass	Pass	Pass	Pass	Conditional Pass

Table 1b. Littelfuse Automotive TVS Diode series compliance with various surge levels in 24V powertrains

TVS Series	24V System											
	Level 3						Level 4					
	1	2a	2b	3a	3b	5a	1	2a	2b	3a	3b	5a
	-300V	+37V	+20V	-150V	+150V	+123V	-600V	+112V	+20V	-300V	+300V	+173V
SZSMF	Pass	Pass	Pass	Pass	Pass	-	Pass	Pass	Pass	Pass	Pass	-
SZSMF4L/ SZSMF	Pass	Pass	Pass	Pass	Pass	-	Pass	Pass	Pass	Pass	Pass	-
TPSMA6L/ SZ1SMA	Pass	Pass	Pass	Pass	Pass	-	Pass	Pass	Pass	Pass	Pass	-
TPSMB/ SZ1SMB / SZP6SMB	Pass	Pass	Pass	Pass	Pass	-	Pass	Pass	Pass	Pass	Pass	-
TPSMC/ SZ1SMC / SZ1.5SMC	Pass	Pass	Pass	Pass	Pass	-	Pass	Pass	Pass	Pass	Pass	-
TPSMD	Pass	Pass	Pass	Pass	Pass	-	Pass	Pass	Pass	Pass	Pass	-
TP5.0SMD/ SZ5KASMC												
TP6KE	Pass	Pass	Pass	Pass	Pass	-	Pass	Pass	Pass	Pass	Pass	-
TP1.5KE	Pass	Pass	Pass	Pass	Pass	-	Pass	Pass	Pass	Pass	Pass	-
TP5KP	Pass	Pass	Pass	Pass	Pass	-	Pass	Pass	Pass	Pass	Pass	-
SLD	Pass	Pass	Pass	Pass	Pass	Conditional Pass	Pass	Pass	Pass	Pass	Pass	Conditional Pass
SLD5S/SLD6S/SLD8S	Pass	Pass	Pass	Pass	Pass	Conditional Pass	Pass	Pass	Pass	Pass	Pass	Conditional Pass

Figure 3b. TVS diode used as a shunt/transient surge protector for various car systems

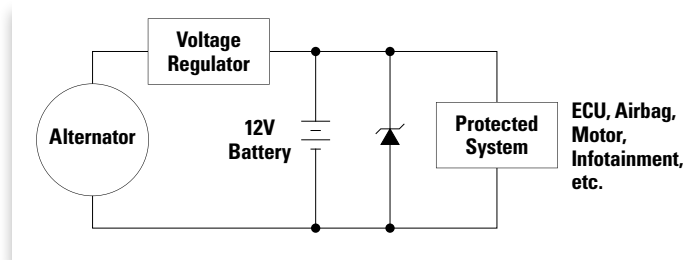

As shown in Figure 3b, the TVS diode TPSMA6L30A is placed before the ECU, sensors, airbag controllers, motor, etc. When the alternator provides power to the electronics, the TVS diode will protect against unwanted transients while allowing DC operating voltage of 12–14V to the electronic systems.

Automotive Bus Protection

The most popular communication bus standards currently are the CAN and LIN buses.

CAN bus (Control Area Network) is a vehicle bus standard designed to allow microcontrollers and devices to communicate with each other within a vehicle with no need for a host computer.

CAN bus is a message-based protocol, designed specifically for automotive applications but now also used in other areas, such as aerospace, industrial automation and medical equipment.

The popular high-speed CAN bus protocol is ISO11898-2, where this differential protocol is good for high-speed (1.0Mbps) and medium-speed (125Kbps) applications in harsh environments

The ISO11898-2 bus consists of the CAN_H and CAN_L data lines and a common ground signal. It has 12V and 24V systems with different bus voltages.

The **LIN (Local Interconnect Network)** bus standard is a serial network protocol used for communication between components in vehicles. As the technologies and the facilities implemented in vehicles grew, a need arose for a cheap serial network because the CAN bus was too expensive to implement for every component in the car. European car manufacturers started using different serial communication topologies, which led to compatibility problems.

The first fully implemented version of the new LIN specification (LIN version 1.3) was published in November 2002. In September 2003, version 2.0 was introduced to expand its capabilities and provide for additional diagnostics features. LIN may also be used over the vehicle's battery power-line with a special DC-LIN transceiver, which is common in today's automotive world.

Table 3a. High-Speed CAN Specifications

Parameter	High-Speed CAN
Physical Layer Specification	ISO 11898-2
Features	High speed differential bus, good noise immunity
Popular Applications	Automotive and industrial controls
Transmission Speed	1.0 Mbits/s @ 40 meters 125 kbits/s @ 500 meters
Cable	Twisted or parallel pair wires, shielded or unshielded cable
Termination Resistance	120 W resistors located at each end of the bus
Min/Max Bus Voltage	12 V System: -3.0/+16 V 24 V System: -3.0/+32 V
Min/Max Common Mode Bus Voltage	CAN_L: -2.0 (min)/+2.5 V (nom) CAN_H: 2.5 (nom)/+7.0 V (max)

Table 3b. LIN Bus Applications

Application Segments	Specific LIN Application Examples
Roof	Sensor, light sensor, light control, sun roof
Steering Wheel	Cruise control, wiper, turning light, climate control, radio
Seat	Seat position motors, occupant sensors, control panel
Engine	Sensors, small motors
Climate	Small motors, control panel
Door	Mirror, central ECU, mirror switch, window lift, seat control switch, door lock

Differences between CAN and LIN Bus Applications

Control Area Network (CAN) systems handle everything from power steering to the critical drive-train communications between the engine computer and the transmission. Local Interconnect Network (LIN) systems handle simple electromechanical functions, such as moving the power seats and toggling the cruise control.

Threats to CAN Bus and LIN Bus in the Automotive World

Because CAN Bus and LIN Bus are two-wire communication busses for various control and monitor functions inside the car, they have a high chance of getting surges into the two wires and causing failure on the CAN/LIN transceivers. The following are protection methods for these two busses.

Figure 4. CAN Bus Protection

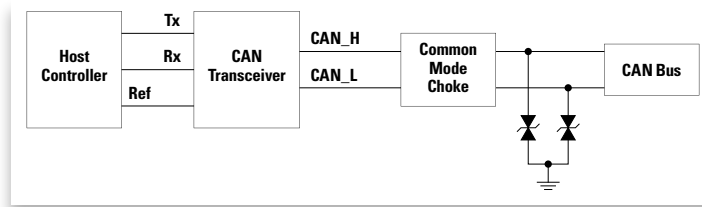

CAN Bus Protection Scheme

As shown in **Figure 4**, the [TPSMB30CA](#) TVS diode is designed to protect the two CAN bus lines in common-mode (with 24V system) from the surge events. [TPSMB24CA](#) is a 600W bi-directional TVS diode with 25.6V reverse standoff voltage and 41.4V maximum clamping voltage. It is ideal for protecting the CAN bus without clipping the CAN signals. In a 12V CAN system, two [TPSMB15CA](#) TVS diodes are used instead of the [TPSMB24CA](#).

Figure 5. LIN Bus Protection

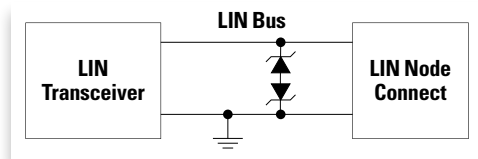

LIN Bus Protection Scheme

A LIN transceiver has signal ranges from +24 /-15V and data rate of 2.4kbps to 20kbps. As seen in **Figure 5**, it needs a bidirectional asymmetrical TVS configuration to protect the two wires in a differential mode.

[TPSMA6L24A/TPSMA6L15A](#) TVS diodes are connected in anti in-series mode to protect the two wires from surge events. The [TPSMA6L](#) TVS diode is a 600W device housed in a small DO-221AC package. An alternative solution with same power handling capability would be to add a [TPSMB30CA](#) (bi-directional) to protect the LIN bus.

Automotive Standard ISO16750-2 Vs. ISO7637-2 for Pulse 5 (Load Dump surge test)

Littelfuse TVS products in ISO16750-2

ISO 16750-2 was prepared by Technical Committee ISO/TC 22, Road vehicles, Subcommittee SC 3, Electrical and electronic equipment. In 2010, ISO16750 replace ISO7637 for load dump pulse 5a and 5b portion. Here we will list these two standard difference and give a guideline for load dump protection component selection.

Load dump

This test is a simulation of load dump transient occurring in the event of a discharged battery being disconnected while the alternator is generating charging current to other loads remaining on the alternator circuit.

Based on below 2 waveforms definitions, we can see there is a difference between the t_r rising slope. ISO16750 defines the rising slope from 10% $(U_s - U_A)$ to 90% $(U_s - U_A)$, while ISO7637-2 defines the rising slope from 10% U_s to 90% U_s .

Figure 6. Pulse 5a waveform in ISO16750-2

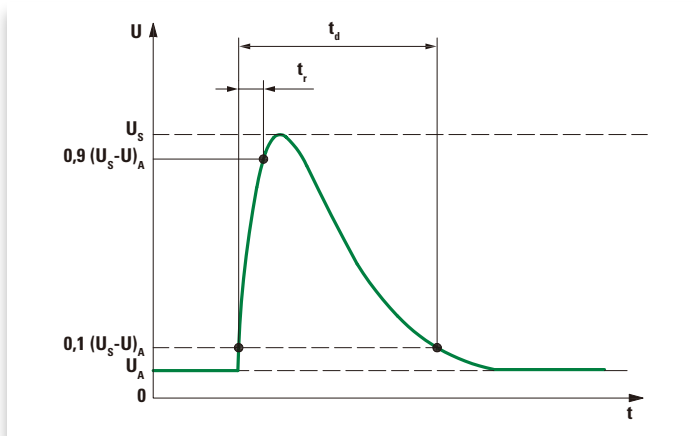

- t time
- U test voltage
- t_d duration of pulse
- t_r rising slope
- U_A supply voltage for generator in operation (see ISO 16750-2)
- U_s supply voltage

Figure 7. Pulse 5a waveform in ISO7637-2

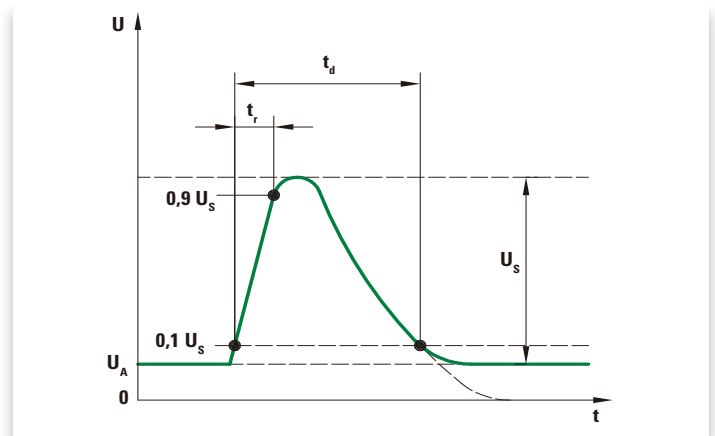

- t time
- U test voltage
- t_d duration of pulse
- t_r rising slope
- U_A supply voltage for generator in operation (see ISO 7637-2)
- U_s supply voltage (Does not include U_A)

Base on above waveform definition, we can see there is a slight difference between the rising slope t_r for pulse 5b U_s and U_s^* in ISO16750-2 and ISO7637-2.

Figure 8. Pulse 5b waveform in ISO16750-2

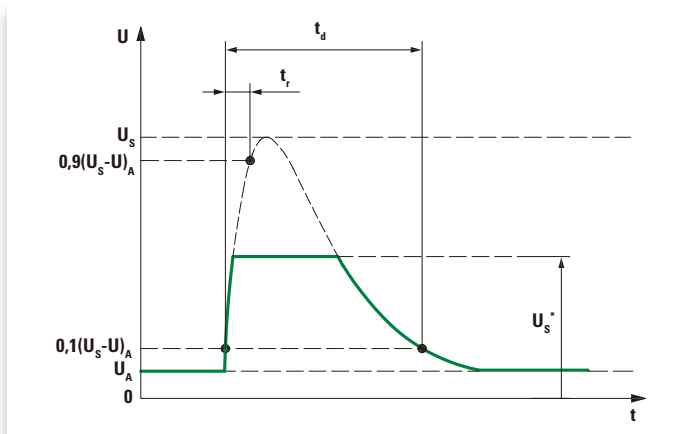

- t time
- U test voltage
- t_d duration of pulse
- t_r rising slope
- U_s supply voltage
- U_A supply voltage for generator in operation (see ISO 16750-2)
- U_s^* supply voltage with load dump suppression

Figure 9. Pulse 5b waveform in ISO7637-2

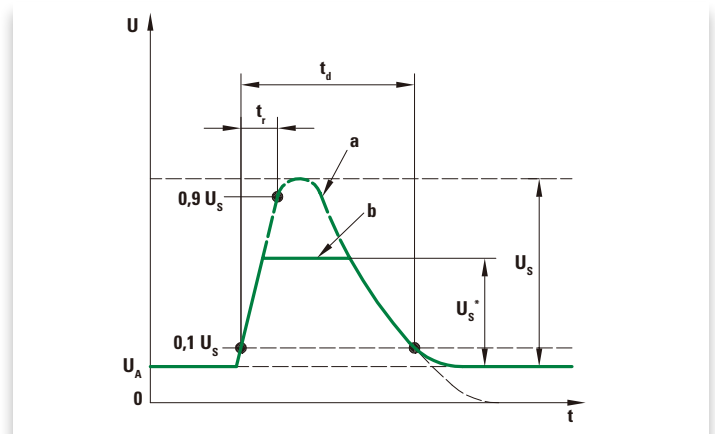

- t time
- U test voltage
- t_d duration of pulse
- t_r rising slope
- U_A supply voltage for generator in operation (see ISO 16750-2)
- U_s supply voltage (Does not include U_A)
- U_s^* supply voltage with load dump suppression (not include U_A)

One important point here is how to choose a suitable TVS diode to pass ISO-16750-2 5b test for automotive electronics designer. As we have already known that ISO-16750-2 Pulse 5b (here we call it as 5b pulses, in short) is a clamped load dump surge by alternator integrated TVS diode, so other electrical or electronic components' maximum voltage need be designed base on this U_s^* clamped voltage. In some cases, electronics designers may think that the centralized integrated TVS diode clamp voltage U_s^* is still too high for proper protection for the afterwards components. That means a lower clamp voltage TVS diode is needed for such protections. However, with such lower clamp voltage, centralized integrated TVS will be by-passed (or shorted) without dissipating any load dump energy. As a result, all load dump energy will be dissipated on the lower clamp voltage TVS diode. However, this waveform or surge energy level is now actually a ISO)16750-2 5a (without centralized load dump protection) but not that of from 5b. Thus automotive electronics designers need to consider the rating of U_s , R_i and t_d together to determine how high power the clamp TVS diode should take. In this case, normally higher energy SLD series SLD5S, SLD6S or SLD8S series TVS diodes need be considered.

If U_s^* voltage is within TVS diode protection voltage range, then designer just need to select a small power TVS with working voltage a little bit higher than the U_s^* , like TPSMB, TPSMC, TPSMD, SZ1SMB, SZP6SMB, SZ1SMC and SZ1.5SMC to withstand such 5b pulse energy. At the same time, these TVS diode(s) can also able to withstand pulse1, 2a, 3a and 3b other impulses. For detail selection of right TVS diode(s), please refer to below figure 10 and 11 for 12V and 24V system.

The rule for ISO16750 5b U_s^* and TVS V_{br} correlation refer to below SOA (Safe Operation Area) curve.

Figure 10. 12v 5b V_{br} vs. U_s^*

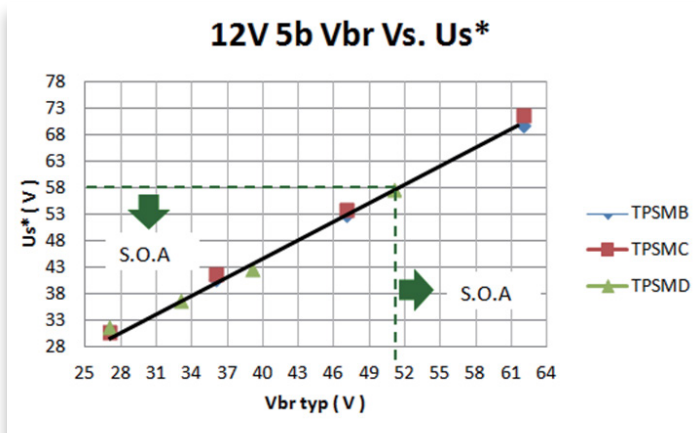

Figure 11. 24v 5b V_{br} vs. U_s^*

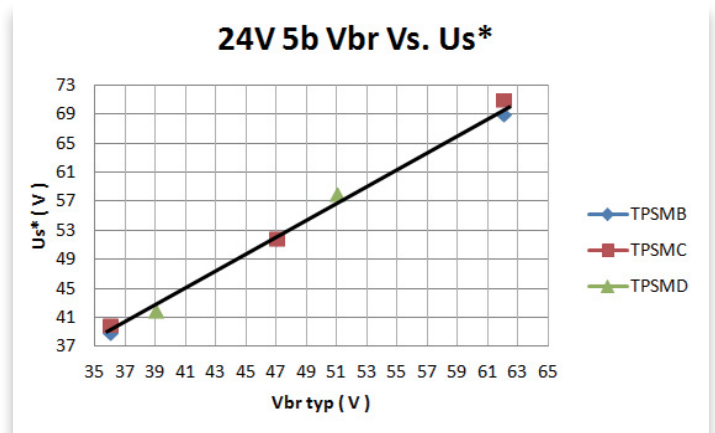

Table 4. Pulse parameter difference comparison between ISO16750-2 and ISO7637-2

Parameter	ISO16750-2		"Min test requirements"	ISO7637-2		"Min test requirements"
	UN=12V	UN=24V		UN=12V	UN=24V	
US(V)	79=<US=<101	151=<US=<202v	10 pulses at intervals of 1 minute	65=<US=<87	123=<US=<174v	1 pulse
US*(V)	35	65		define by user	define by user	
UA(V)	14	28		13~14	26~28	
Ri(ohm)	0.5=<Ri=<4	1=<Ri=<8		0.5=<Ri=<4	1=<Ri=<8	
td(ms)	40=<td=<400	100=<td=<350		40=<td=<400	100=<td=<350	
tr(ms)	10+0/-5	10+0/-5		10+0/-5	10+0/-5	

$$R_i = \frac{10 \times U_{nom} \times N_{act}}{0.8 \times I_{rated} \times 12000min^{-1}}$$

Note: Ri is defined as the Alternator internal resistance

Unom: Specified voltage of the alternator

Irated: Specified current at an alternator speed of 6000 min-1 (as given in ISO 8854)

Nact: Actual alternator speed, in reciprocal minutes.

For example, a traditional small passenger car with alternator 14V & 60A, its Ri at Nact 3000min-1 is $10 \times 14 \times 3000 / (0.8 \times 60 \times 12000)$, it is about 0.73ohm.

Major differences

ISO16750-2 defines 10 pulses in 10 minutes with 1 minute interval, while the old ISO7637-2 standard defines only 1 pulse. Thus, the protector must have a higher reliability for this load dump protection in this new requirement.

As seen in figure 12 and 13 below, we use typical 12v and 24v AEC-Q101 qualified TVS for load dump pulse 5a test verification and comparison between ISO16750-2 and ISO7637-2.

Below is typical open load dump waveform for 12v and 24v system.

Figure 12. 12v system 101v 400mS pulse

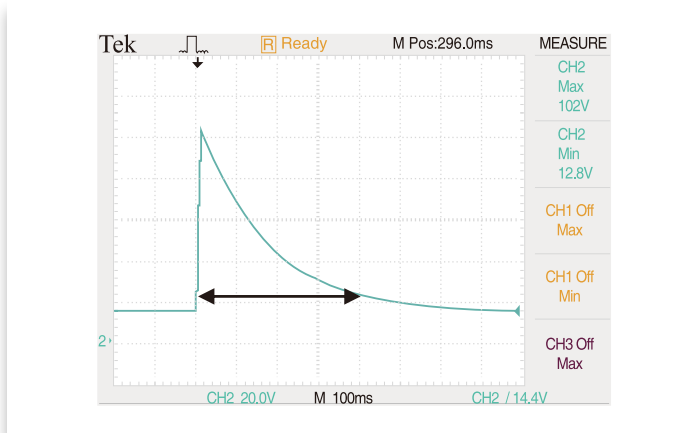
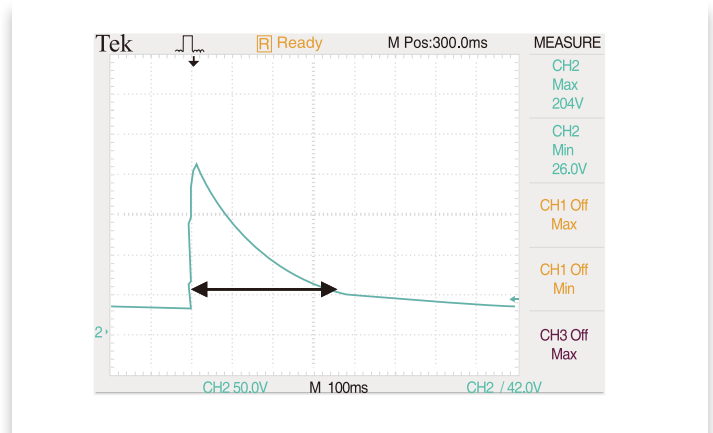

Figure 13. 24v system 202v 350mS pulse



In Figure 14 and 15 below, we have a comparison test of ISO16750-2 and ISO7637-2 with different pulses duration in the 12V system. For the supply voltage U_s 65 to 87V range, the R_i resistance required to withstand different pulses (40mS, 220mS and 400mS) is at least more than 1.14 ohm in the ISO7637-2. The upper region of the Figure 14 and 15 is the safe operation area of [SLD15U-017](#) device. Thus, we have to ensure the resultant resistance (Alternator source impedance) on the line exceeding 1.14 ohm to provide sufficient protection for ISO7637-2 pulses. But, in the case of the Figure 10 with ISO16750-2 test requirement, the minimum resistance required on the line is 1.5ohm which is more than that of the ISO7637-2.

Note: [SLD15U-017](#) is a uni-directional TVS diode with 2200W power rating and a reverse standoff voltage 15V and a minimum breakdown voltage 16.7V.

Figure 14. 12v system single pulse(ISO7637-2) U_s Vs. R_i

Note: Each curve above is SOA(Safe Operation Area).

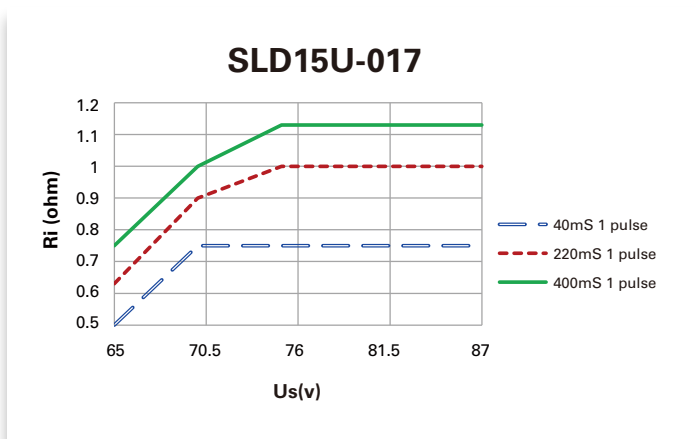
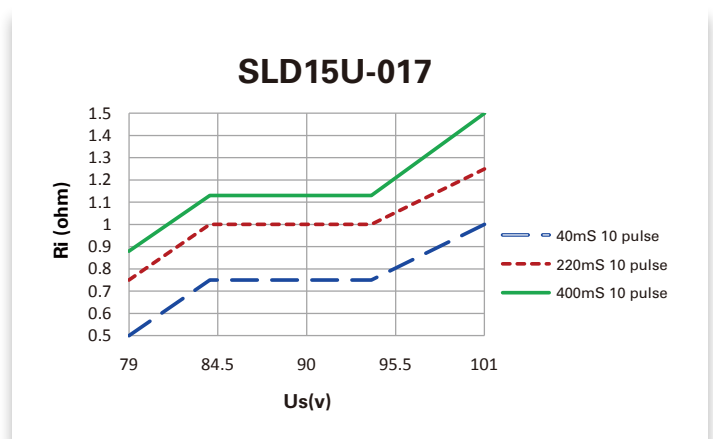

Figure 15. 12v system 10pulses(ISO16750-2) U_s Vs. R_i

Note: Each curve above is SOA(Safe Operation Area).



In Figure 16 and 17 below, we have a comparison test of ISO16750-2 and ISO7637-2 with different pulses duration in the 24V system. For the Supply voltage U_s 123 to 174V range, the R_i resistance required to withstand different pulses (40mS, 220mS and 400mS) is at least more than 4.3 ohm in the ISO7637-2. The upper region of the Figure 16 and 17 is the safe operation area of [SLD33-018](#) device. Thus, we have to ensure the resultant resistance (Alternator source impedance) on the line exceeding 4.3 ohm to provide sufficient protection for ISO7637-2 pulses. But, in the case of the Figure 17 with ISO16750-2 test requirement, the minimum resistance required on the line is 4.5ohm which is a little bit larger than that of the ISO7637-2.

Note: [SLD33-018](#) is a bi-directional TVS diode with 2200W power rating and a reverse standoff voltage 33V and a minimum breakdown voltage 36.7V.

Figure 16. 24v system single pulse(ISO7637-2) U_s Vs. R_i

Note: Each curve above is SOA(Safe Operation Area).

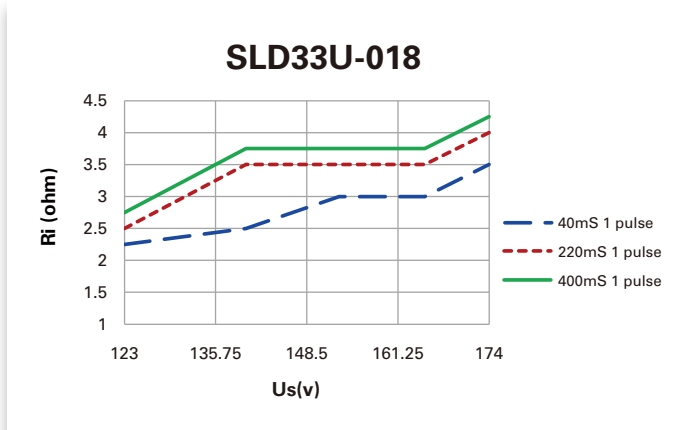

Figure 17. 24v system 10 pulses(ISO16750-2) U_s Vs. R_i

Note: Each curve above is SOA(Safe Operation Area).

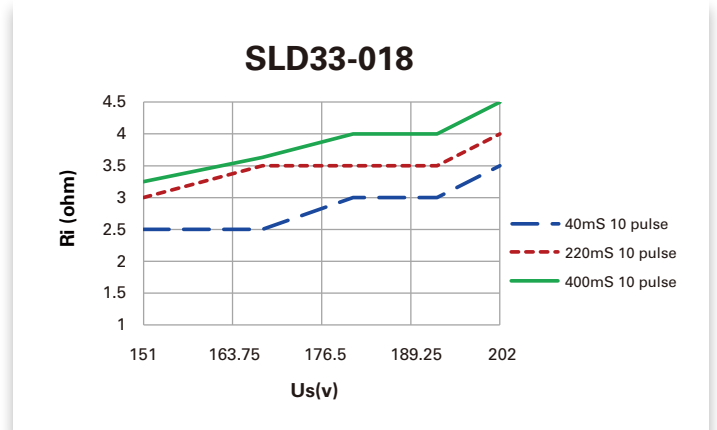

Figure 18. 12v system 10pulses(ISO16750-2) U_s Vs. R_i

Note: Each curve above is SOA(Safe Operation Area).

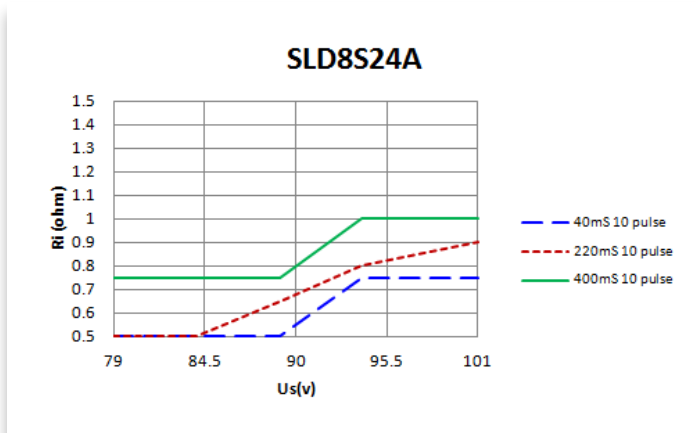
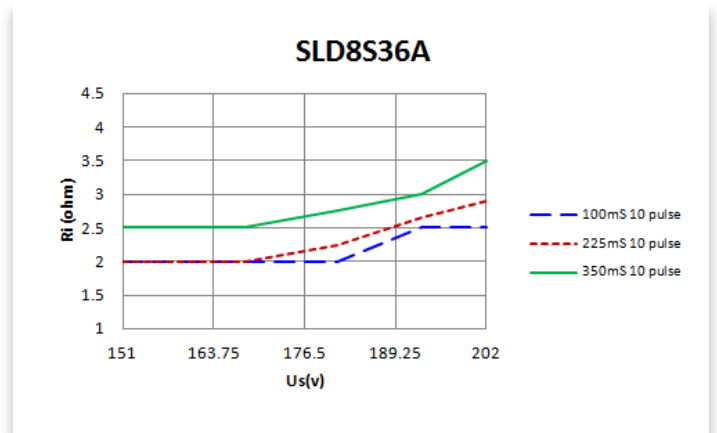

Figure 19. 24v system 10pulses(ISO16750-2) U_s Vs. R_i

Note: Each curve above is SOA(Safe Operation Area).



All above 6 graphs data are tested under normal room temperature. Actual pulse withstand capability could be different with different application environments. The TVS Load dump energy could have de-rated to a lower level with higher environmental temperature. That means, for the same U_s level, R_i would rise a little bit.

Table 5. SLD series Ipp minimum with different pulse width, No. of pulses

	Single pulse			10 pulses		
	40mS	220mS	400mS	40mS	220mS	400mS
SLD15-017	96A	82A	73A	98A	76A	69A
SLD33-018	50.4A	44A	44A	49.6A	40.8A	38.4A

Table 6. SLD series Vclamp maximum with different pulse width, No. of pulses

	Single pulse			10 pulses		
	40mS	220mS	400mS	40mS	220mS	400mS
SLD15-017	25.2V	24.2V	25.1V	24.8V	23.8V	23.7V
SLD33-018	50V	50.4V	50.1V	50V	50V	49.6V

As seen in above table, we have an example and pick suitable parts for your load dump protection. Now we are about to verify if [SLD33-018](#) can meet this protection requirement.

- Voltage: 24v system
- Alternator resistance Ri = 4Ω
- Peak voltage of alternator output in load dump = 202V
- Target clamping voltage = 65V
- Pulse width = 200ms
- Pulse numbers = 10 pulses in 10 minutes

From table 5, we know that [SLD33-018](#) has a 40.8A clamping capability in 10 pulses condition at 220mS pulse width. From table 6, we know that [SLD33-018](#) has max clamping voltage 50V in 10 pulses condition at 220mS pulse width.

The actual load dump peak clamping current can be calculated as $(202V - 50V) / 4\Omega = 38A$ which is lower than the 40.8A. Hence, [SLD33-018](#) can protect the load dump surge (40.8A > 38A).

Since TVS diode is a clamping device, the surge current will be affected by the external resistance. We know from the above, the Ri is the Alternator internal resistance will affect the TVS diode whether it can pass the surge test set by different external applied voltage and surge duration. In the case where the Ri is too low to pass some surge tests, then multiple TVS cascaded in parallel is needed to pass relevant surge test.

TVS Terminology

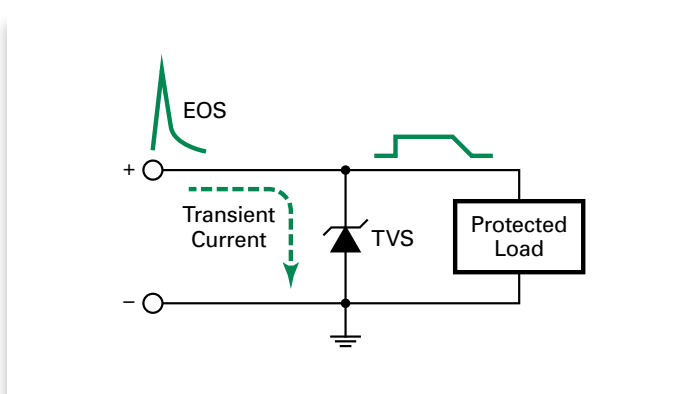

Reverse Standoff Voltage

In the case of a uni-directional TVS diode, this is the maximum peak voltage that may be applied in the “blocking direction” with no significant current flow. In the case of a bi-directional transient, it applies in either direction. It has the same definition as Maximum Off-State Voltage and Maximum Working Voltage.

Breakdown Voltage

The voltage measured at a specified DC test current, typically 1mA. A minimum or maximum value is usually specified.

Peak Pulse Power Rating

Expressed in Watts or Kilowatts, for a 1ms exponential transient. It is IPP multiplied by VCL.

Maximum Clamping Voltage (VC or VCI)

Maximum voltage that can be measured across the protector when subjected to the Maximum Peak Pulse Current.

Peak Pulse Current (IPP)

The Peak Pulse Current (IPP) identifies the maximum current the TVS Diode can withstand without damage. The required IPP can only be determined by dividing the peak transient voltage by the source impedance. Note that the TVS Diode failure mechanism is a short circuit; if the TVS Diode fails due to a transient greater than the datasheet specification, the circuit will still be protected.