

SP6001 Series 12pF 30kV EMI Filter Array

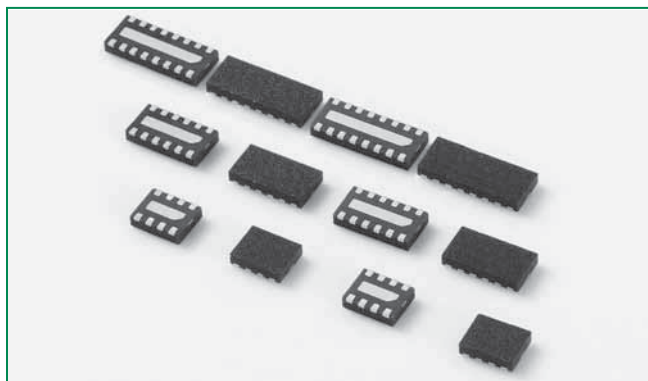

Pinout

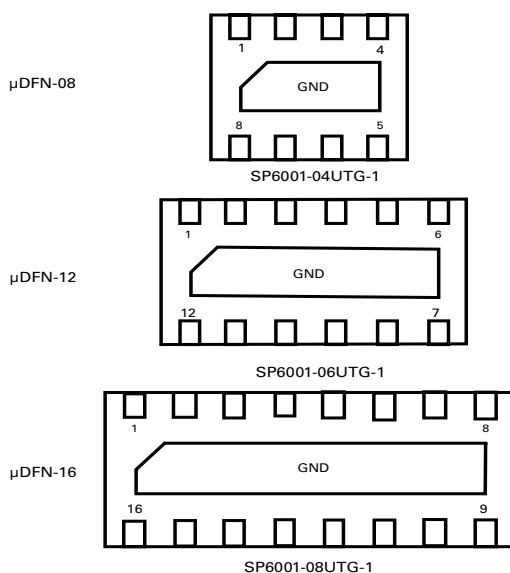

Functional Block Diagram

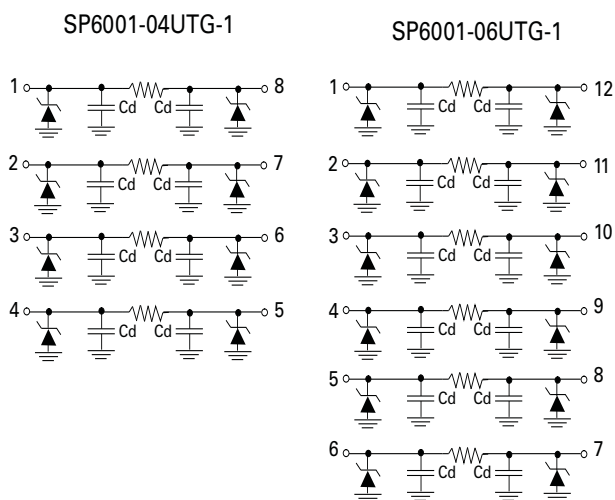

Description

The Littelfuse SP6001 SPA series integrates 4, 6 and 8 EMI filters (C-R-C) into a small, low-profile μDFN package with each filter providing greater than -30dB attenuation at 1GHz. Additionally, each I/O is capable of shunting ±30kV ESD strikes (IEC61000-4-2, contact discharge) away from sensitive electronic components. The performance of this small, slim design makes it extremely suitable for mobile handsets, PDAs and notebook computers.

Features

- EMI filtering of frequencies from 800MHz to 3GHz
- Greater than -30dB attenuation (TYP) at 1GHz
- ESD, IEC61000-4-2, ±30kV contact, ±30kV air
- Small, low-profile μDFN (JEDEC MO-229) package (TYP 0.5mm height)

Applications

- Keypad interface for portable electronics
- LCD and camera display interfaces for handsets
- Connector interfaces for portable electronics
- Mobile phone
- Smartphone
- Portable navigation device

Application Examples

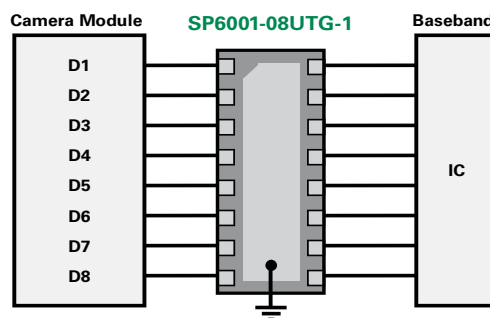
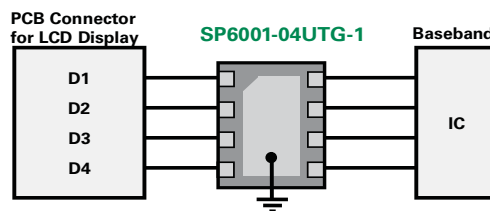

Absolute Maximum Ratings

Symbol	Parameter	Value	Units
T _{OP}	Operating Temperature	-40 to 85	°C
T _{STOR}	Storage Temperature	-60 to 150	°C

CAUTION: Stresses above those listed in "Absolute Maximum Ratings" may cause permanent damage to the device. This is a stress only rating and operation of the device at these or any other conditions above those indicated in the operational sections of this specification is not implied.

Thermal Information

Parameter	Rating	Units
Storage Temperature Range	-65 to 150	°C
Maximum Junction Temperature	150	°C
Maximum Lead Temperature (Soldering 20-40s)	260	°C

Electrical Characteristics (T_{OP}=25°C)

Parameter	Symbol	Test Conditions	Min	Typ	Max	Units
Reverse Standoff Voltage	V _{RWM}				6.0	V
Breakdown Voltage	V _{BR}	I _R =1mA	7.0 (90%TYP)	7.8	8.5 (109%TYP)	V
Reverse Leakage Current	I _{LEAK}	V _{RWM} =5V		0.1	1.0	µA
Resistance	R _A	I _R =10mA	85 (85%TYP)	100	115 (115% TYP)	Ω
Diode Capacitance ^{1,2}	C _D	V _R =2.5V,f=1MHz		12		pF
Line Capacitance ^{1,2}	C _L	V _R =2.5V,f=1MHz	19 (79.2%TYP)	24	29 (120.8%TYP)	pF
ESD Withstand Voltage ¹	V _{ESD}	IEC61000-4-2 (Contact Discharge)	±30			kV
		IEC61000-4-2 (Air Discharge)	±30			kV
Cutoff Frequency ³	F _{-3dB}	Above this frequency, appreciable attenuation occurs		115		MHz

Notes: ¹ Parameter is guaranteed by design and/or device characterization.

² Total line capacitance is two times the diode capacitance (C_D).

³ 50Ω source and 50Ω load termination

Insertion Loss (S21)

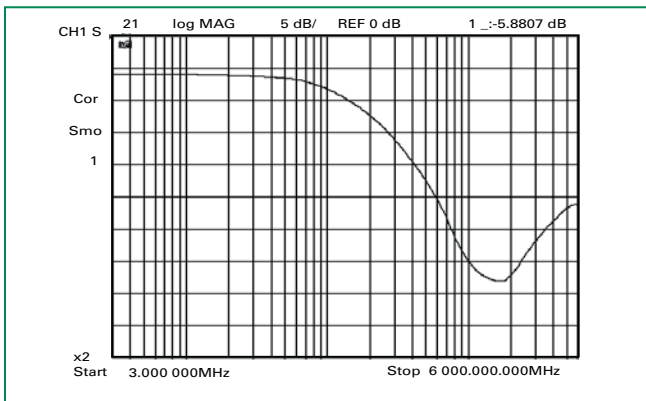

Analog Crosstalk (S41)

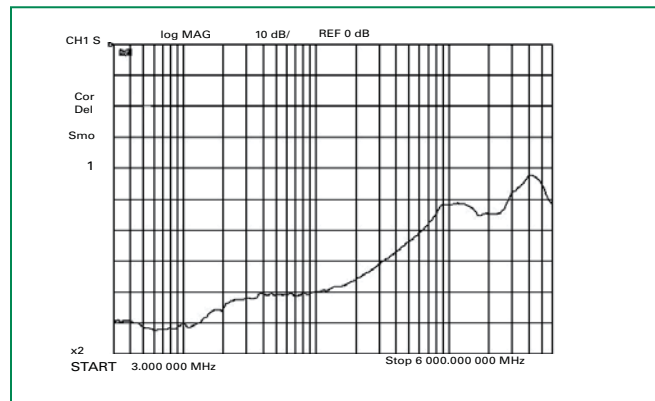

Product Characteristics

Lead Plating	Pre-Plated Frame
Lead Material	Copper Alloy
Lead Coplanarity	0.0004 inches (0.102mm)
Substitute Material	Silicon
Body Material	Molded Epoxy
Flammability	UL 94 V-0

Notes :

1. All dimensions are in millimeters
2. Dimensions include solder plating.
3. Dimensions are exclusive of mold flash & metal burr.
4. Blo is facing up for mold and facing down for trim/form, i.e. reverse trim/form.
5. Package surface matte finish VDI 11-13.

Line Capacitance vs. DC Bias

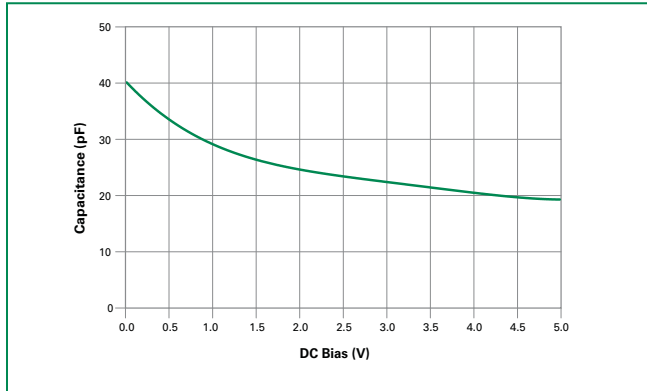

Package Dimensions — μDFN-08

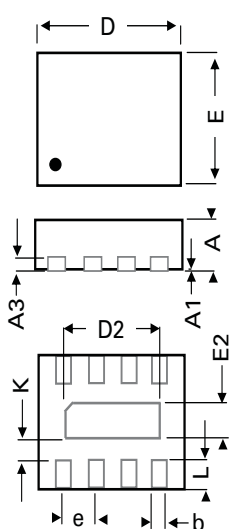

	μDFN-08			
	JEDEC MO-229			
	Millimeters		Inches	
	Min	Max	Min	Max
A	0.450	0.550	0.018	0.022
A1	0.000	0.050	0.000	0.002
A3	0.127 REF		0.005 REF	
b	0.150	0.250	0.006	0.010
D	1.600	1.800	0.063	0.071
D2	1.100	1.300	0.043	0.051
E	1.250	1.450	0.049	0.057
E2	0.300	0.500	0.012	0.020
e	0.400 BSC		0.016 BSC	
K	0.200		0.008	0.000
L	0.150	0.350	0.006	0.014

Package Dimensions — μDFN-16

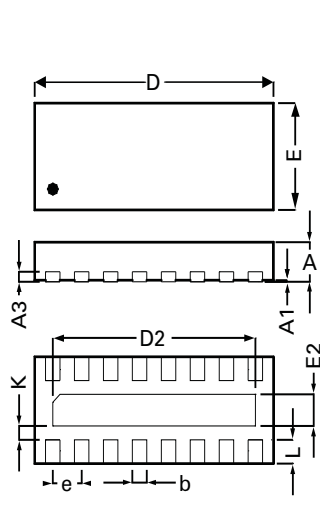

	μDFN-16			
	JEDEC MO-229			
	Millimeters		Inches	
	Min	Max	Min	Max
A	0.45	0.55	0.01	0.02
A1	0.00	0.05	0.00	0.002
A3	0.127 REF		0.00 REF	
b	0.15	0.25	0.00	0.00
D	3.20	3.40	0.12	0.13
D2	2.70	2.90	0.10	0.11
E	1.25	1.45	0.04	0.05
E2	0.30	0.50	0.01	0.01
e	0.40 BSC		0.01 BSC	
K	0.20		0.00	
L	0.15	0.35	0.00	0.01

Soldering Parameters

Reflow Condition		Pb – Free assembly
Pre Heat	- Temperature Min ($T_{s(min)}$)	150°C
	- Temperature Max ($T_{s(max)}$)	200°C
	- Time (min to max) (t_s)	60 – 180 secs
Average ramp up rate (Liquidus Temp (T_L) to peak)		3°C/second max
$T_{s(max)}$ to T_L - Ramp-up Rate		3°C/second max
Reflow	- Temperature (T_L) (Liquidus)	217°C
	- Temperature (t_L)	60 – 150 seconds
Peak Temperature (T_p)		260 ^{+0/-5} °C
Time within 5°C of actual peak Temperature (t_p)		20 – 40 seconds
Ramp-down Rate		6°C/second max
Time 25°C to peak Temperature (T_p)		8 minutes Max.
Do not exceed		260°C

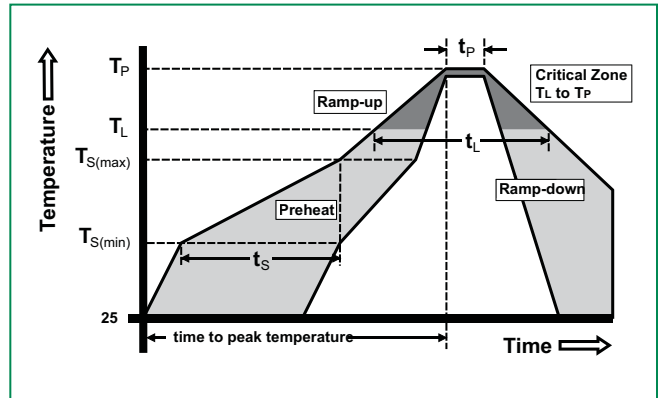

Package Dimensions — μDFN-12

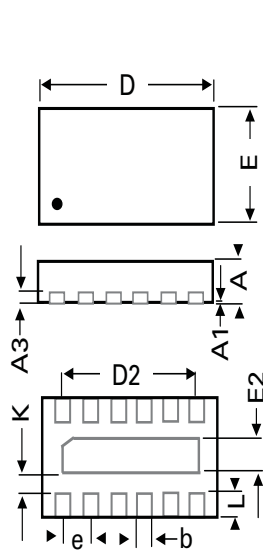

	μDFN-12			
	JEDEC MO-229			
	Millimeters		Inches	
	Min	Max	Min	Max
A	0.450	0.550	0.018	0.022
A1	0.000	0.050	0.000	0.002
A3	0.127 REF		0.005 REF	
b	0.150	0.250	0.006	0.010
D	2.400	2.600	0.094	0.102
D2	1.900	2.100	0.075	0.083
E	1.250	1.450	0.049	0.057
E2	0.300	0.500	0.012	0.020
e	0.400 BSC		0.016 BSC	
K	0.200		0.008	0.000
L	0.150	0.350	0.006	0.014

SP6001

Embossed Carrier Tape & Reel Specification – μDFN-08

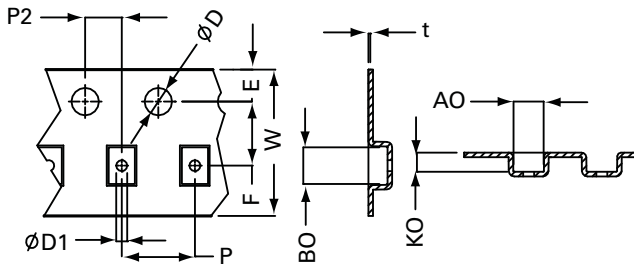

	Millimetres		Inches	
	Min	Max	Min	Max
E	1.65	1.85	0.065	0.073
F	3.45	3.55	0.136	0.140
D1	1.00	-	0.040	-
D	1.50 min		0.059 min	
P	3.90	4.10	0.154	0.161
10P	40.0 +/- 0.20		1.575 +/- 0.008	
W	7.70	8.30	0.303	0.327
P2	1.95	2.05	0.077	0.081
A0	1.55	1.75	0.061	0.069
B0	1.90	2.1	0.075	0.083
K0	0.95	1.15	0.037	0.045
t	0.30 max		0.012 max	

Embossed Carrier Tape & Reel Specification – μDFN-12

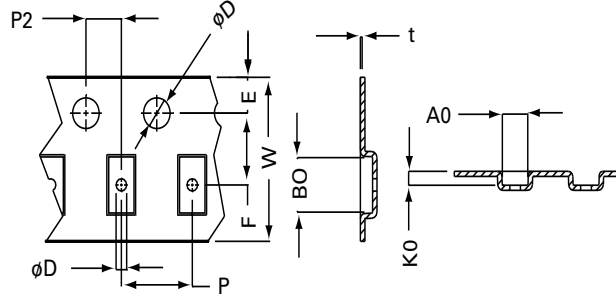

	Millimetres		Inches	
	Min	Max	Min	Max
E	1.65	1.85	0.065	0.073
F	3.45	3.55	0.136	0.140
D1	0.55	0.65	0.021	0.025
D	1.50 min		0.059 min	
P	3.90	4.10	0.154	0.161
10P	40.0 +/- 0.20		1.575 +/- 0.008	
W	7.90	8.30	0.311	0.327
P2	1.95	2.05	0.077	0.081
A0	1.33	1.53	0.052	0.060
B0	2.63	2.83	0.103	0.111
K0	0.58	0.78	0.023	0.031
t	0.22 max		0.009 max	

Embossed Carrier Tape & Reel Specification – μDFN-16

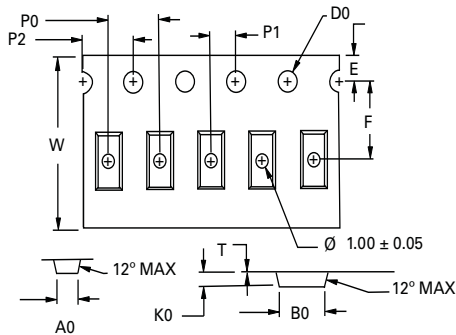

	Millimetres		Inches	
	Min	Max	Min	Max
A0	1.55	1.75	0.06	0.06
B0	3.50	3.70	0.13	0.14
D0	1.40	1.60	0.05	0.06
E	1.65	1.85	0.06	0.07
F	5.45	5.55	0.21	0.21
K0	0.85	1.05	0.03	0.04
P0	3.90	4.10	0.15	0.16
P1	1.95	2.05	0.07	0.08
P2	3.90	4.10	0.15	0.16
T	0.26	0.30	0.01	0.01
W	11.90	12.30	0.46	0.48

Part Numbering System

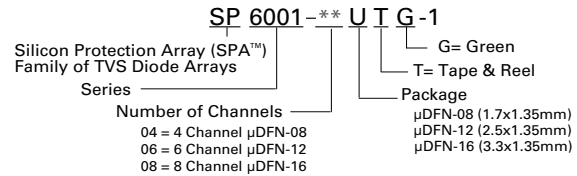

Part Marking System

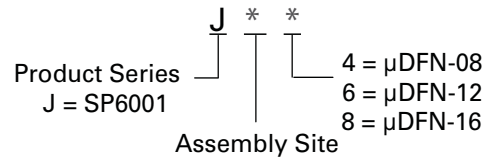

Ordering Information

Part Number	Package	Size (mm)	Marking	Min. Order Qty.
SP6001-04UTG-1	μDFN-08	1.7x1.35	J*4	3000
SP6001-06UTG-1	μDFN-12	2.5x1.35	J*6	3000
SP6001-08UTG-1	μDFN-16	3.3x1.35	J*8	3000