

SP4042 Series 3.3V Diode Array

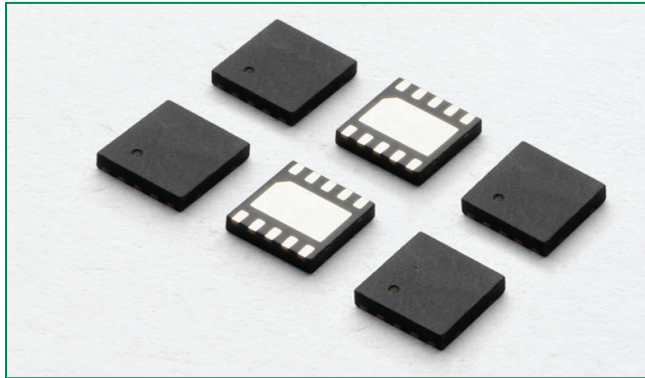

Pinout

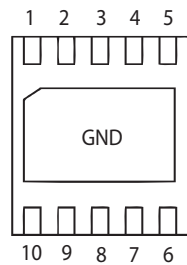

Functional Block Diagram

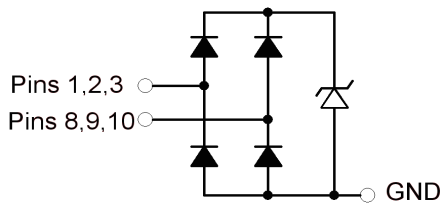

Description

The SP4042 integrates low capacitance steering diodes with a TVS diode to provide 2 channels of protection against lightning induced surge events and ESD. This robust device can safely absorb up to 120A per IEC61000-4-5 ($t_p = 2/10\mu s$) without performance degradation and a minimum $\pm 30kV$ ESD per IEC61000-4-2 international standard. The low loading capacitance makes the SP4042 ideal for protecting Ethernet interfaces.

Features

- ESD, IEC61000-4-2, $\pm 30kV$ contact, $\pm 30kV$ air
- Lightning, IEC61000-4-5 2nd edition, 120A ($t_p = 2/10\mu s$)
- EFT, IEC61000-4-4, 40A ($t_p = 5/50ns$)
- Low capacitance of 11pF (TYP) per line
- Low leakage current of 0.1 μA (MAX) at 3.3V
- Lead-free and RoHS compliant

Applications

- 10/100/1000 Ethernet Interfaces
- Customer Premise Equipment (CPE)
- Carrier Class Equipment
- PBX Systems

Life Support Note:

Not Intended for Use in Life Support or Life Saving Applications

The products shown herein are not designed for use in life sustaining or life saving applications unless otherwise expressly indicated.

Absolute Maximum Ratings

| Symbol | Parameter | Value | Units |
|------------|--------------------------------------|------------|-------|
| I_{PP} | Peak Current ($t_p=8/20\mu s$) | 95 | A |
| I_{PP} | Peak Current ($t_p=2/10\mu s$) | 120 | A |
| P_{PK} | Peak Pulse Power ($t_p=2/10\mu s$) | 2500 | W |
| T_{OP} | Operating Temperature | -40 to 85 | °C |
| T_{STOR} | Storage Temperature | -55 to 150 | °C |

CAUTION: Stresses above those listed in "Absolute Maximum Ratings" may cause permanent damage to the device. This is a stress only rating and operation of the device at these or any other conditions above those indicated in the operational sections of this specification is not implied.

Thermal Information

| Parameter | Rating | Units |
|---|------------|-------|
| Storage Temperature Range | -55 to 150 | °C |
| Maximum Junction Temperature | 150 | °C |
| Maximum Lead Temperature (Soldering 20-40s) | 260 | °C |

Electrical Characteristics ($T_{OP}=25^\circ C$)

| Parameter | Symbol | Test Conditions | Min | Typ | Max | Units |
|---|---------------|---------------------------------------|----------|------|-----|----------|
| Reverse Standoff Voltage | V_{RWM} | $I_R \leq 1\mu A$, Line to Line | | | 3.3 | V |
| Reverse Breakdown Voltage | V_{BR} | $I_T = 1mA$, Line to Line | 3.5 | | | V |
| Snap Back Voltage | V_{SB} | $I_{SB} = 50mA$ | 2.8 | | | V |
| Reverse Leakage Current | I_{LEAK} | $V_R = 3.3V$, Line to Line | | | 0.1 | μA |
| Clamp Voltage, Line to GND ¹ | V_C | $I_{PP} = 100A$, $t_p = 2/10\mu s$ | | 17 | 22 | V |
| Clamp Voltage, Line to Line ¹ | | $I_{PP} = 100A$, $t_p = 2/10\mu s$ | | 22 | 25 | V |
| ESD Withstand Voltage ¹ | V_{ESD} | IEC61000-4-2 (Contact) | ± 30 | | | kV |
| | | IEC61000-4-2 (Air) | ± 30 | | | kV |
| Dynamic Resistance, Line to GND ² | R_{DYN} | TLP, $t_p = 100ns$ | | 0.05 | | Ω |
| Dynamic Resistance, Line to Line ² | | | | 0.15 | | Ω |
| Diode Capacitance ¹ | $C_{I/O-GND}$ | Line to GND, $V_R = 0V$, $f = 1MHz$ | | 11 | 25 | pF |
| | $C_{I/O-I/O}$ | Line to Line, $V_R = 0V$, $f = 1MHz$ | | 5.5 | 12 | pF |

Note: 1 Parameter is guaranteed by design and/or device characterization.

2 Transmission Line Pulse (TLP) test setting : Std.TDRI(50Q), $t_p=100ns$, $tr=0.2ns$ ITLP and VTLP averaging window: star $t1=70ns$ to end $t2=80ns$

Wave Form 2/10 μs Clamping Voltage vs. Peak Pulse Current (Line to GND)

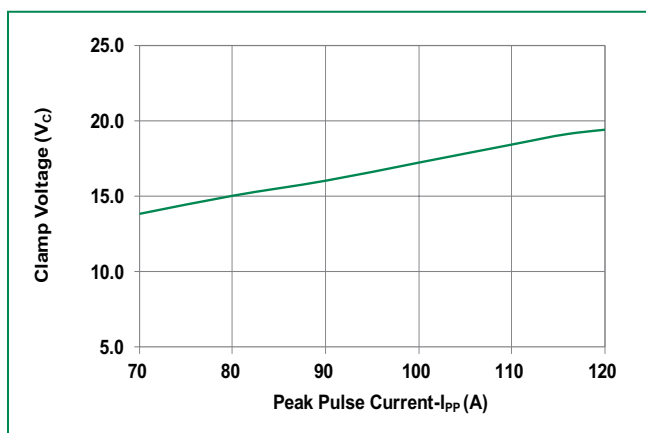

Capacitance vs. Reverse Bias (Line to GND)

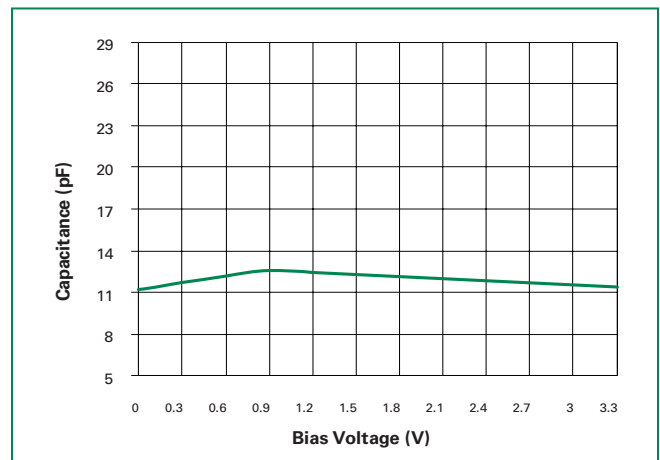

Non-Repetitive Peak Pulse Power vs. Pulse Time

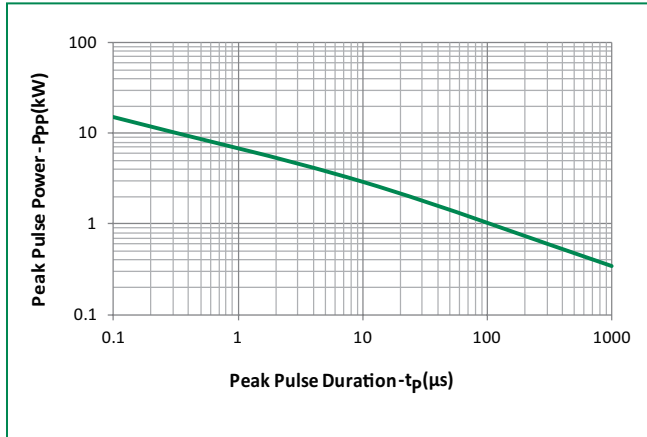

Positive Transmission Line Pulsing (TLP) Plot (Line to GND)

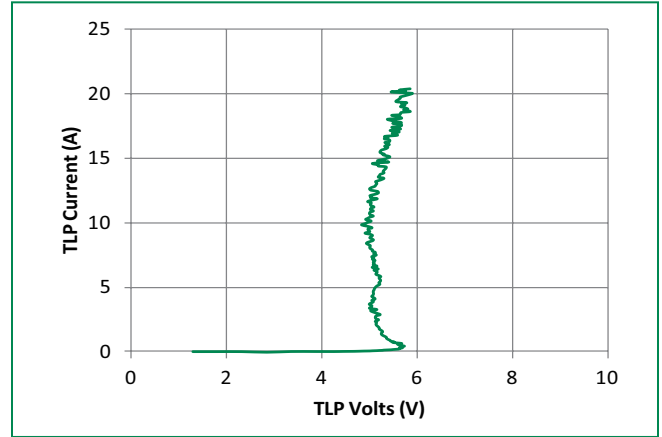

Soldering Parameters

| | | |
|--|------------------------------------|------------------|
| Reflow Condition | Pb – Free assembly | |
| Pre Heat | - Temperature Min ($T_{s(min)}$) | 150°C |
| | - Temperature Max ($T_{s(max)}$) | 200°C |
| | - Time (min to max) (t_s) | 60 – 180 secs |
| Average ramp up rate (Liquidus) Temp (T_L) to peak | 3°C/second max | |
| $T_{s(max)}$ to T_L - Ramp-up Rate | 3°C/second max | |
| Reflow | - Temperature (T_L) (Liquidus) | 217°C |
| | - Temperature (t_L) | 60 – 150 seconds |
| Peak Temperature (T_p) | 260 ^{+0/-5} °C | |
| Time within 5°C of actual peak Temperature (t_p) | 20 – 40 seconds | |
| Ramp-down Rate | 6°C/second max | |
| Time 25°C to peak Temperature (T_p) | 8 minutes Max. | |
| Do not exceed | 260°C | |

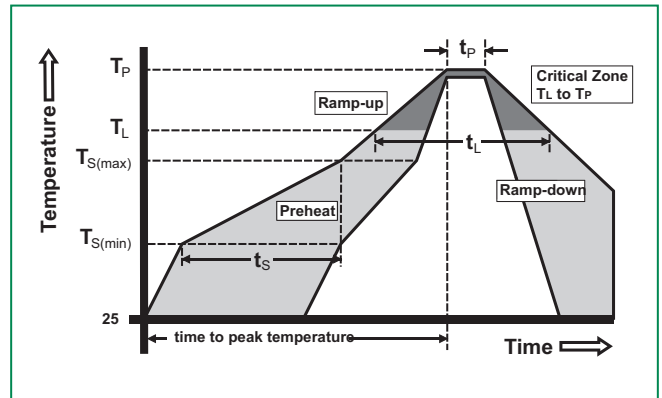

Product Characteristics

| | |
|---------------------------|-----------------------|
| Lead Plating | Pre-Plated Frame |
| Lead Material | Copper Alloy |
| Lead Coplanarity | 0.004 inches(0.102mm) |
| Substrate material | Silicon |
| Body Material | Molded Epoxy |
| Flammability | UL 94 V-0 |

Notes :

1. All dimensions are in millimeters
2. Dimensions include solder plating.
3. Dimensions are exclusive of mold flash & metal burr.
4. Blo is facing up for mold and facing down for trim/form, i.e. reverse trim/form.
5. Package surface matte finish VDI 11-13.

Part Numbering System

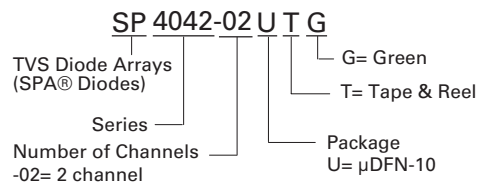

Ordering Information

| Part Number | Package | Marking | Min. Order Qty. |
|--------------|--------------|---------|-----------------|
| SP4042-02UTG | μ DFN-10 | A2*2 | 3000 |

Part Marking System

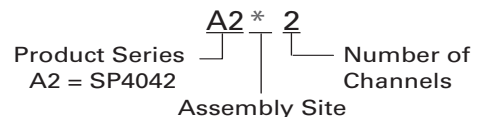

Package Dimensions — μ DFN-10

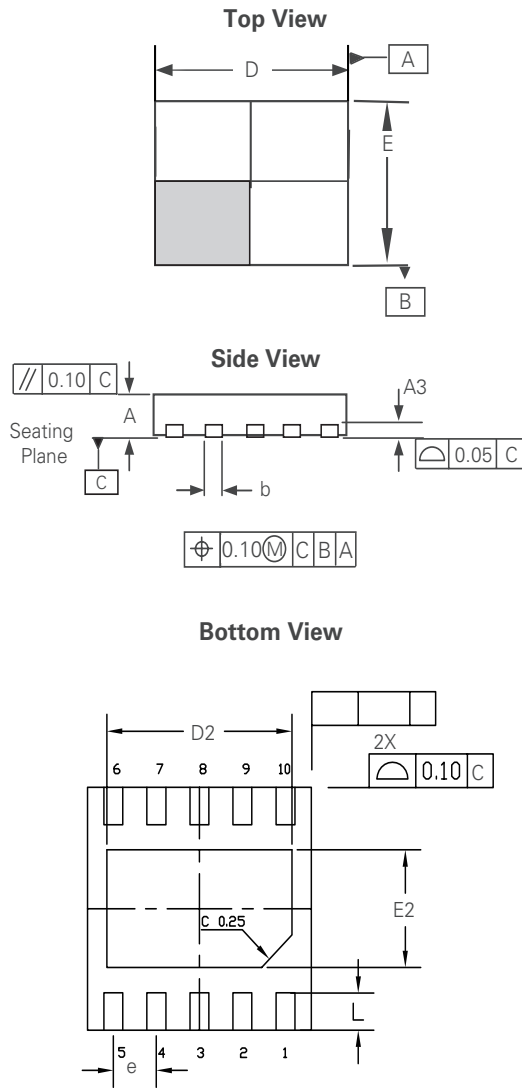

| Package | μ DFN-10 (2.6x2.6mm) | | | | | |
|-----------|--------------------------|------|------|-----------|-------|-------|
| JEDEC | MO-229 | | | | | |
| Symbol | Millimeters | | | Inches | | |
| | Min | Nom | Max | Min | Nom | Max |
| A | 0.45 | 0.52 | 0.55 | 0.018 | 0.020 | 0.022 |
| A3 | 0.127Ref | | | 0.005 Ref | | |
| b | 0.17 | 0.22 | 0.27 | 0.006 | 0.009 | 0.011 |
| D | 2.50 | 2.60 | 2.70 | 0.098 | 0.102 | 0.106 |
| D2 | 2.10 | 2.15 | 2.20 | 0.083 | 0.085 | 0.087 |
| E | 2.50 | 2.60 | 2.70 | 0.098 | 0.102 | 0.106 |
| E2 | 1.21 | 1.26 | 1.31 | 0.048 | 0.050 | 0.052 |
| e | 0.50 BSC | | | 0.020 BSC | | |
| L | 0.35 | 0.40 | 0.45 | 0.014 | 0.016 | 0.018 |

RECOMMENDED SOLDER PAD

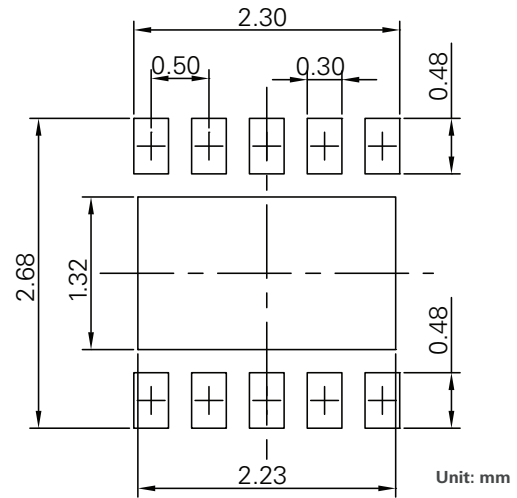

Embossed Carrier Tape & Reel Specification — μ DFN-10 (2.6x2.6mm)

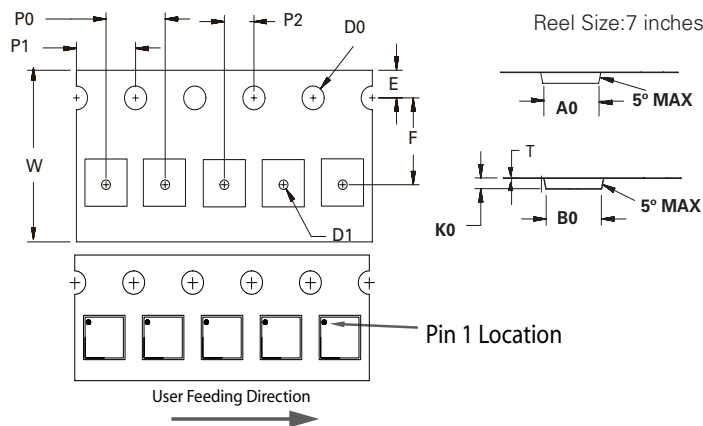

| Symbol | Millimeters |
|-----------|---------------------|
| A0 | 2.82 +/- 0.05 |
| B0 | 2.82 +/- 0.05 |
| D0 | $\phi 1.50 + 0.10$ |
| D1 | $\phi 0.50 + 0.05$ |
| E | 1.75 +/- 0.10 |
| F | 3.50 +/- 0.05 |
| K0 | 0.76 +/- 0.05 |
| P0 | 4.00 +/- 0.10 |
| P1 | 4.00 +/- 0.10 |
| P2 | 2.00 +/- 0.05 |
| T | 0.25 +/- 0.02 |
| W | 8.00 + 0.30 /- 0.10 |