

SP3031 Series 0.8pF 10kV Unidirectional Discrete TVS

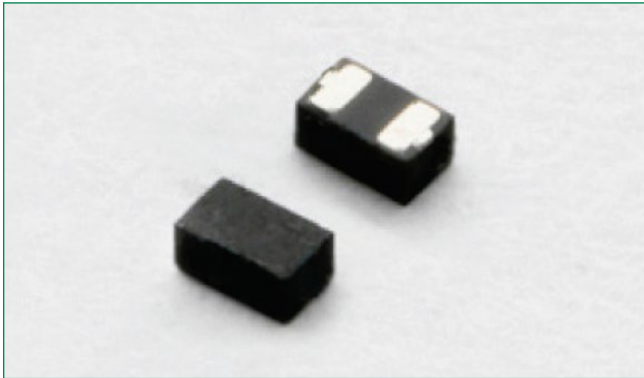

Pinout

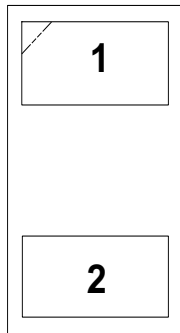

Functional Block Diagram

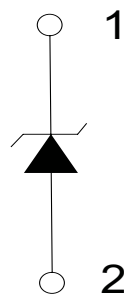

Additional Information



Datasheet



Resources



Samples

Life Support Note:

Not Intended for Use in Life Support or Life Saving Applications

The products shown herein are not designed for use in life sustaining or life saving applications unless otherwise expressly indicated.

Description

The SP3031 is a single channel low capacitance diode that provides protection for electronic equipment that may experience destructive electrostatic discharges (ESD). This robust diode can safely absorb repetitive ESD strikes above the maximum level specified in the IEC 61000-4-2 international standard (Level 4, ±8 kV contact discharge and ±15 kV air discharge) without performance degradation. The low loading capacitance makes it ideal for protecting high speed data lines.

Features

- RoHS-Compliant, Lead-Free and Halogen-Free
- ESD protection of ±10kV contact discharge, ±15kV air discharge, (IEC 61000-4-2)
- EFT, IEC 61000-4-4, 40A (5/50ns)
- Lightning protection, IEC 61000-4-5, 2nd Edition: 8/20µs Surge, 5A Surge
- Low capacitance of 0.8pF @ V_R=0V
- Low leakage current of 1µA at 5V
- Moisture Sensitivity Level(MSL-1)
- AEC-Q101 Qualified

Applications

- USB 2.0, Ethernet
- MHL/MIPI/MDDI
- HDMI, Display Port, eSATA
- Set Top Boxes, Game Consoles
- Smart Phones
- External Storage
- Ultrabooks, Notebooks
- Tablets, eReaders
- Automotive

USB2.0 Application Example

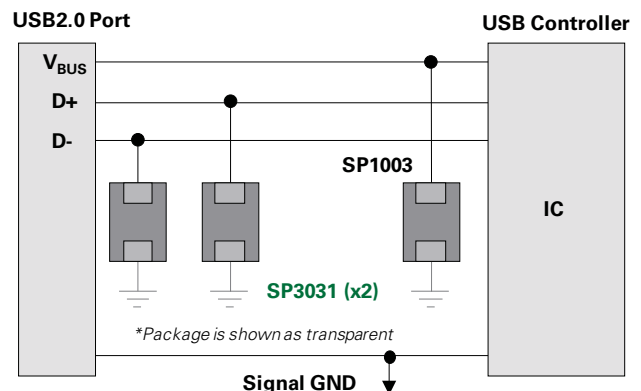

Absolute Maximum Ratings

Symbol	Parameter	Value	Units
I_{PP}	Peak Current ($t_p=8/20\mu s$)	5.0	A
T_{OP}	Operating Temperature	-40 to 125	°C
T_{STOR}	Storage Temperature	-55 to 150	°C

CAUTION: Stresses above those listed in "Absolute Maximum Ratings" may cause permanent damage to the component. This is a stress only rating and operation of the component at these or any other conditions above those indicated in the operational sections of this specification is not implied.

Electrical Characteristics ($T_{OP}=25^\circ C$)

Parameter	Symbol	Test Conditions	Min	Typ	Max	Units
Reverse Standoff Voltage	V_{RWM}	$I^R=1\mu A$			5.0	V
Breakdown Voltage	V_{BR}	$I_R=1mA$	6.0			V
Reverse Leakage Current	I_{LEAK}	$V_R=5V$			1	μA
Clamp Voltage ¹	V_C	$I_{PP}=1A, t_p=8/20\mu s, I/O$ to GND		6.9		V
		$I_{PP}=2A, t_p=8/20\mu s, I/O$ to GND		7.5		V
Dynamic Resistance ²	R_{DYN}	TLP, $t_p=100ns, I/O$ to GND		0.6		Ω
ESD Withstand Voltage ¹	V_{ESD}	IEC 61000-4-2 (Contact)	± 10			kV
		IEC 61000-4-2 (Air)	± 15			kV
Diode Capacitance ¹	$C_{I/O-I/O}$	Reverse Bias=0V, $f=1$ MHz		0.8		pF

Note: 1. Parameter is guaranteed by design and/or component characterization.

2. Transmission Line Pulse (TLP) with 100ns width, 2ns rise time, and average window $t_1=70ns$ to $t_2=90ns$

Insertion Loss (S21) I/O to GND

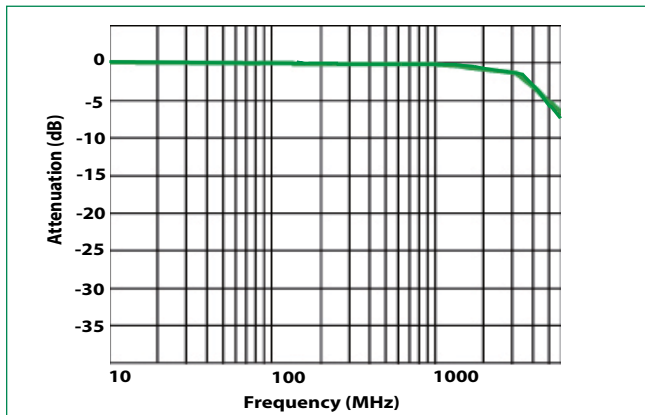

Capacitance vs. Reverse Voltage

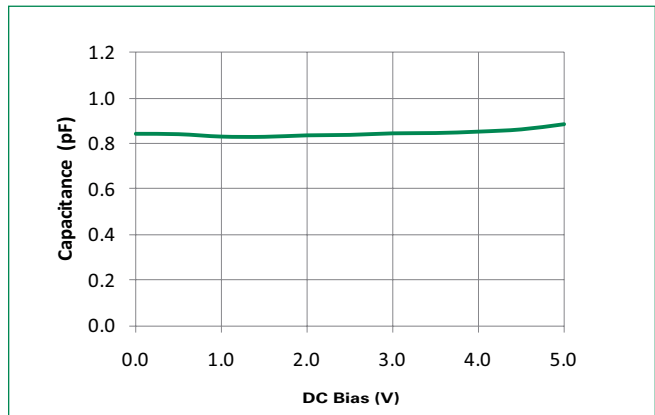

8/20 μs Waveform

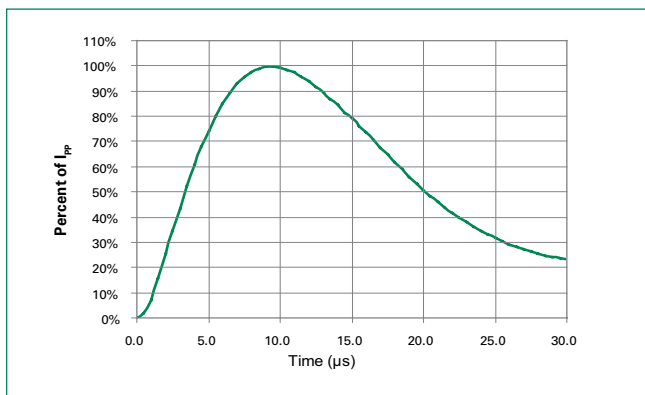

8kV Clamping Voltage

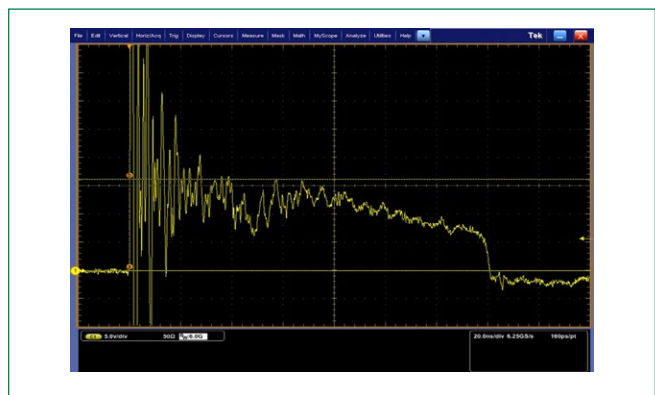

Product Characteristics

Lead Plating	Pre-Plated Frame
Lead Material	Copper Alloy
Substitute Material	Silicon
Body Material	Molded Compound
Flammability	UL Recognized compound meeting flammability rating V-0

Ordering Information

Part Number	Package	Min. Order Qty.
SP3031-01ETG	SOD882	10000

Soldering Parameters

Reflow Condition	Pb – Free assembly	
Pre Heat	- Temperature Min ($T_{s(min)}$)	150°C
	- Temperature Max ($T_{s(max)}$)	200°C
	- Time (min to max) (t_s)	60 – 180 secs
Average ramp up rate (Liquidus) Temp (T_L) to peak	3°C/second max	
$T_{s(max)}$ to T_L - Ramp-up Rate	3°C/second max	
Reflow	- Temperature (T_L) (Liquidus)	217°C
	- Temperature (t_L)	60 – 150 seconds
Peak Temperature (T_p)	260 ^{+0/-5} °C	
Time within 5°C of actual peak Temperature (t_p)	20 – 40 seconds	
Ramp-down Rate	6°C/second max	
Time 25°C to peak Temperature (T_p)	8 minutes Max.	
Do not exceed	260°C	

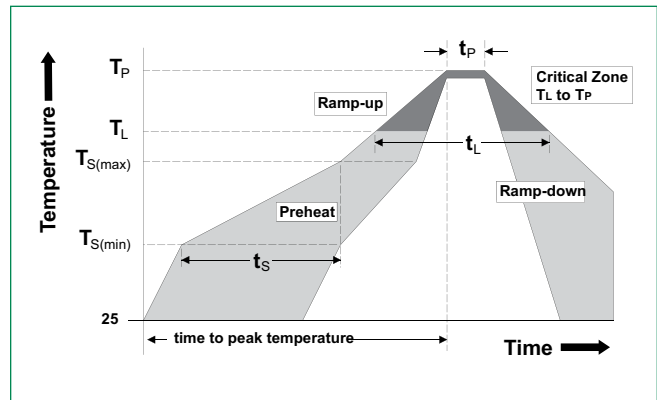

Part Numbering System

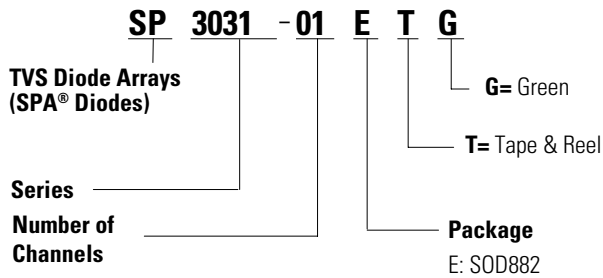

Part Marking System

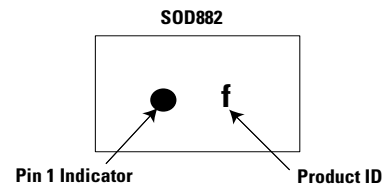

Package Dimensions – SOD882

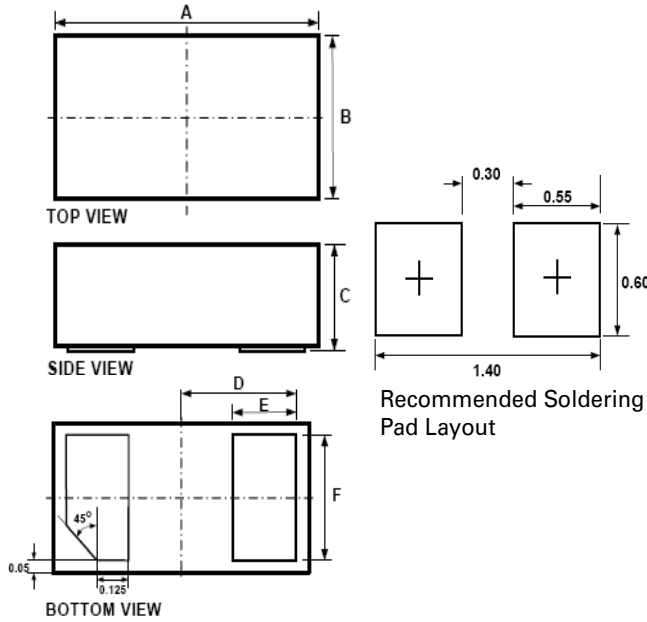

Symbol	Package	SOD882				
	JEDEC	MO-236				
	Millimeters			Inches		
	Min	Typ	Max	Min	Typ	Max
A	0.90	1.00	1.10	0.035	0.039	0.043
B	0.50	0.60	0.70	0.020	0.024	0.028
C	0.40	0.50	0.60	0.016	0.020	0.024
D	0.45			0.018		
E	0.20	0.25	0.35	0.008	0.010	0.012
F	0.45	0.50	0.55	0.018	0.020	0.022

Embossed Carrier Tape & Reel Specification – SOD882

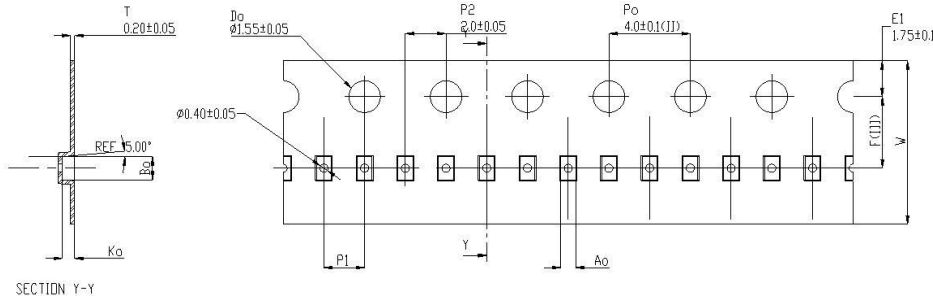

Symbol	Millimeters
A0	0.70±0.045
B0	1.10±0.045
K0	0.65±0.045
F	3.50±0.05
P1	2.00±0.10
W	8.00 + 0.30 -0.10

Device Orientation in Tape

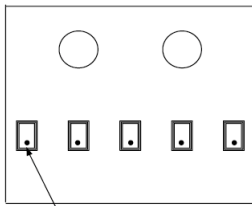

8mm TAPE AND REEL

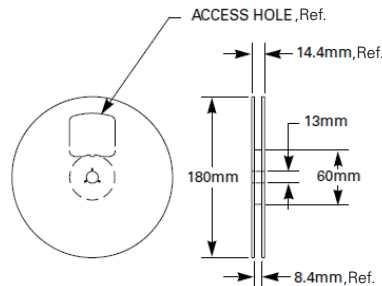

Notes:
1. All dimensions are in millimeters