

SP3003 Series

0.65pF Diode Array

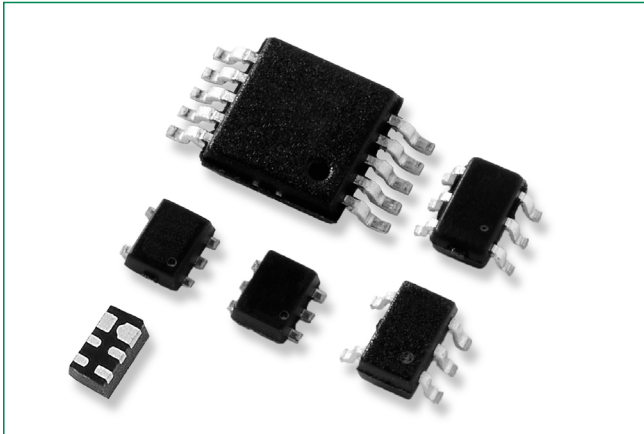

Additional Information



Resources



Accessories



Samples

Pinout

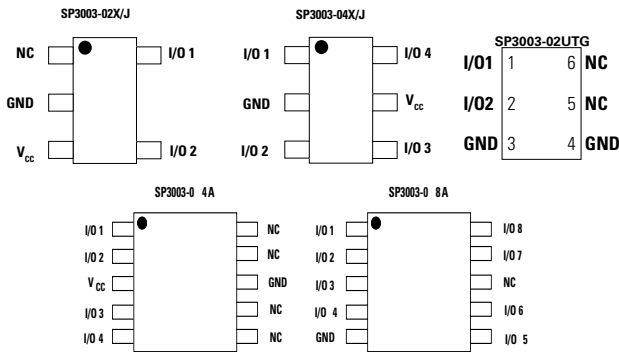

Application Example

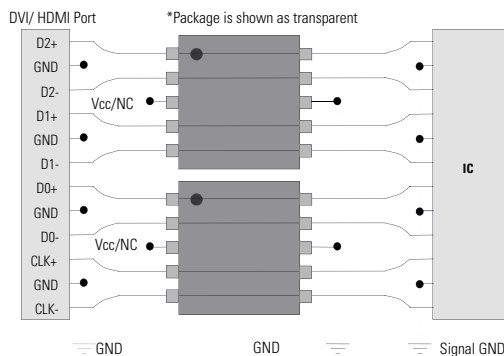

Description

The SP3003 has ultra low capacitance rail-to-rail diodes with an additional protection diode fabricated in a proprietary silicon avalanche technology to protect each I/O pin providing a high level of protection for electronic equipment that may experience destructive electrostatic discharges (ESD). These robust diodes can safely absorb repetitive ESD strikes at the maximum level specified in the IEC 61000-4-2 international standard (Level 4, ±8kV contact discharge and ± 15 kV air discharge without performance degradation. Their very low loading capacitance also makes them ideal for protecting high speed signal pins such as HDMI, DVI, USB2.0, and IEEE 1394.

Features & Benefits

- ESD protection of ±8kV contact discharge, ±15kV air discharge, (IEC 61000-4-2)
- EFT protection, IEC 61000-4-4, 40A (5/50ns)
- Lightning, 2.5A (8/20µs as defined in IEC 61000-4-5 2nd Edition)
- Low capacitance of 0.65pF (TYP) per I/O
- Low leakage current of 0.5µA (MAX) at 5V
- Complete line of small packaging helps save board space (SC70, SOT553, SOT563, MSOP10, µDFN-6L)
- AEC-Q101 qualified
- RoHS compliant and lead-free
- Moisture Sensitivity Level(MSL-1)

Applications

- LCD/ PDP TVs
- DVD Players
- Desktops
- MP3/ PMP
- Digital Cameras
- Set Top Boxes
- Mobile Phones
- Notebooks
- Computer Peripherals

Functional Block Diagram

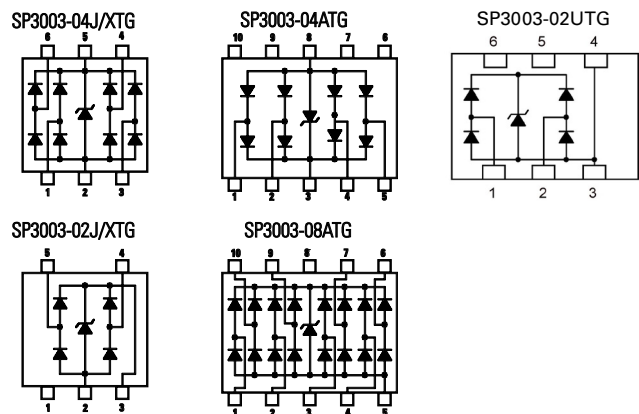

Life Support Note:

Not Intended for Use in Life Support or Life Saving Applications

The products shown herein are not designed for use in life sustaining or life saving applications unless otherwise expressly indicated.

A single, 4 channel SP3003-04 component can be used to protect four (4) of the data lines in a HDMI/DVI interface so two (2) SP3003-04 components provide protection for all eight (8) TMDS lines.

SP3003 Series

0.65pF Diode Array

Absolute Maximum Ratings

Symbol	Parameter	Value	Units
I_{PP}	Peak Current ($t_p=8/20\mu s$)	2.5	A
T_{OP}	Operating Temperature	-40 to 125	°C
T_{STOR}	Storage Temperature	-55 to 150	°C

Caution: Stresses above those listed in "Absolute Maximum Ratings" may cause permanent damage to the component. This is a stress only rating and operation of the component at these or any other conditions above those indicated in the operational sections of this specification is not implied.

Electrical Characteristics ($T_{OP}=25^\circ C$)

Parameter	Symbol	Test Conditions	Min	Typ	Max	Units
Reverse Standoff Voltage	V_{RWM}	$I_R \leq 1\mu A$			6	V
Reverse Leakage Current	I_{LEAK}	$V_R=5V$			0.5	μA
Clamp Voltage ¹	V_C	$I_{PP}=1A, t_p=8/20\mu s$		10.0	12.0	V
		$I_{PP}=2A, t_p=8/20\mu s$		11.8	15.0	V
ESD Withstand Voltage ¹	V_{ESD}	IEC61000-4-2 (Contact)	± 8			kV
		IEC61000-4-2 (Air)	± 15			kV
Diode Capacitance ¹	$C_{I/O-GND}$	Reverse Bias=0V	0.7	0.8	0.95	pF
		Reverse Bias=1.65V	0.55	0.65	0.8	pF
Diode Capacitance ¹	$C_{I/O-I/O}$	Reverse Bias=0V		0.35		pF

Note: 1. Parameter is guaranteed by design and/or component characterization.

Insertion Loss (S21) I/O to GND

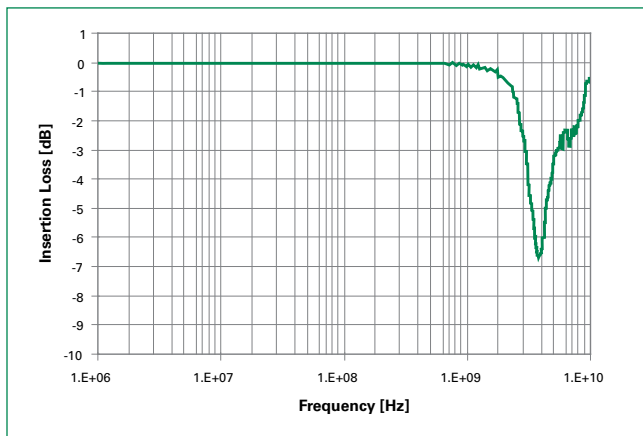

Capacitance I/O - GND vs. Bias Voltage

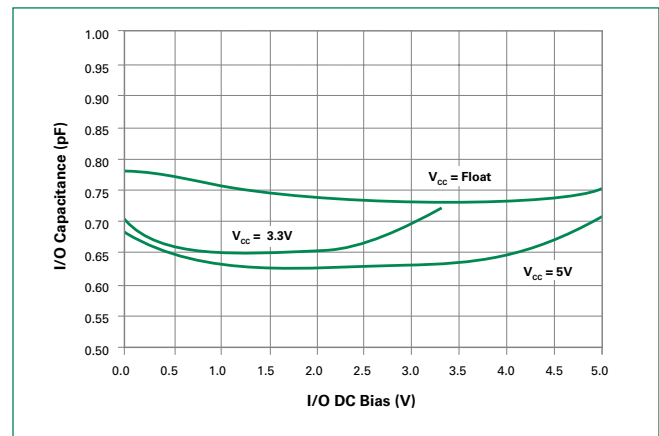

SP3003 Series

0.65pF Diode Array

Capacitance vs. Frequency

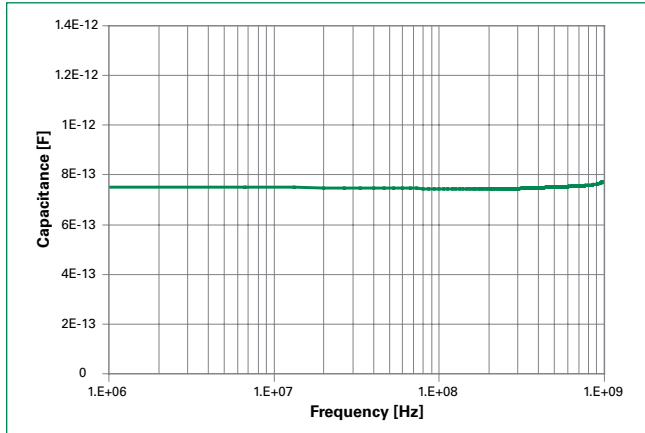

Product Characteristics

Lead Plating	Matte Tin (SC70-x) Pre-Plated Frame (SOT5x3, μ DFN-6, MSOP-10)
Lead Material	Copper Alloy
Lead Coplanarity	0.0004 inches (0.102mm)
Substrate Material	Silicon
Body Material	Molded Compound
Flammability	UL Recognized compound meeting flammability rating V-0

Soldering Parameters

Reflow Condition	Pb – Free assembly	
Pre Heat	- Temperature Min ($T_{s(min)}$)	150°C
	- Temperature Max ($T_{s(max)}$)	200°C
	- Time (min to max) (t_s)	60 – 120 secs
Average ramp up rate (Liquidus) Temp (T_L) to peak	3°C/second max	
$T_{s(max)}$ to T_L - Ramp-up Rate	3°C/second max	
Reflow	- Temperature (T_L) (Liquidus)	217°C
	- Temperature (t_L)	60 – 150 seconds
Peak Temperature (T_p)	260 ^{+0/-5} °C	
Time within 5°C of actual peak Temperature (t_p)	30 seconds	
Ramp-down Rate	6°C/second max	
Time 25°C to peak Temperature (T_p)	8 minutes Max.	
Do not exceed	260°C	

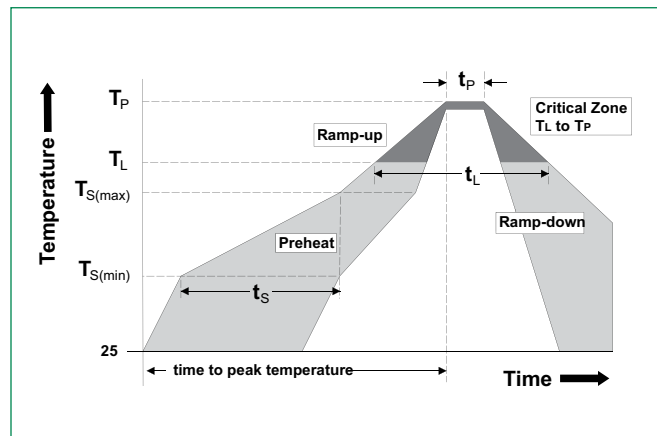

SP3003 Series

0.65pF Diode Array

Package Dimensions — SC70-5

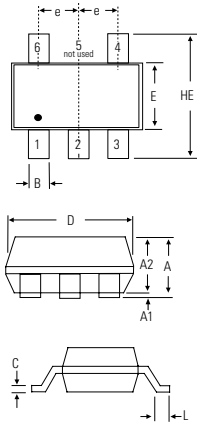

Recommended Solder Pad Layout

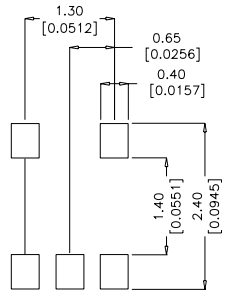

Package	SC70-5			
Pins	5			
JEDEC	MO-203			
Symbol	Millimeters		Inches	
	Min	Max	Min	Max
A	0.80	1.10	0.031	0.043
A1	0.00	0.10	0.000	0.004
A2	0.70	1.00	0.028	0.039
B	0.15	0.30	0.006	0.012
c	0.08	0.25	0.003	0.010
D	1.85	2.25	0.073	0.089
E	1.15	1.35	0.045	0.053
e	0.65 BSC		0.026 BSC	
HE	2.00	2.40	0.079	0.094
L	0.26	0.46	0.010	0.018

Package Dimensions — SC70-6

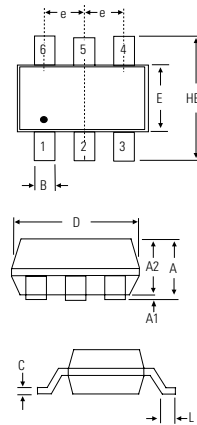

Recommended Solder Pad Layout

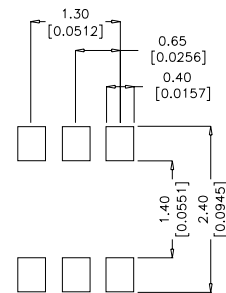

Package	SC70-6			
Pins	6			
JEDEC	MO-203			
Symbol	Millimeters		Inches	
	Min	Max	Min	Max
A	0.80	1.10	0.031	0.043
A1	0.00	0.10	0.000	0.004
A2	0.70	1.00	0.028	0.039
B	0.15	0.30	0.006	0.012
c	0.08	0.25	0.003	0.010
D	1.85	2.25	0.073	0.089
E	1.15	1.35	0.045	0.053
e	0.65 BSC		0.026 BSC	
HE	2.00	2.40	0.079	0.094
L	0.26	0.46	0.010	0.018

Package Dimensions — SOT553

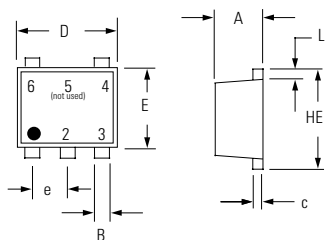

Recommended Solder Pad Layout

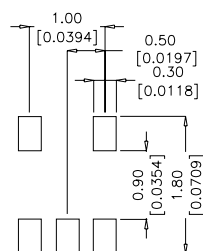

Package	SOT 553			
Pins	5			
Symbol	Millimeters		Inches	
	Min	Max	Min	Max
A	0.50	0.60	0.020	0.024
B	0.17	0.27	0.007	0.011
c	0.08	0.18	0.003	0.007
D	1.50	1.70	0.059	0.067
E	1.10	1.30	0.043	0.051
e	0.50 BSC		0.020 BSC	
L	0.10	0.30	0.004	0.012
HE	1.50	1.70	0.059	0.067

SP3003 Series

0.65pF Diode Array

Package Dimensions — SOT563

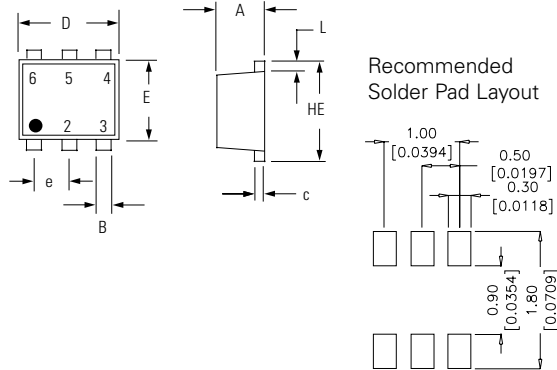

Package	SOT 563			
Pins	6			
Symbol	Millimeters		Inches	
	Min	Max	Min	Max
A	0.50	0.60	0.020	0.024
B	0.17	0.27	0.007	0.011
c	0.08	0.18	0.003	0.007
D	1.50	1.70	0.059	0.067
E	1.10	1.30	0.043	0.051
e	0.50 BSC		0.020 BSC	
L	0.10	0.30	0.004	0.012
HE	1.50	1.70	0.059	0.067

Package Dimensions — MSOP10

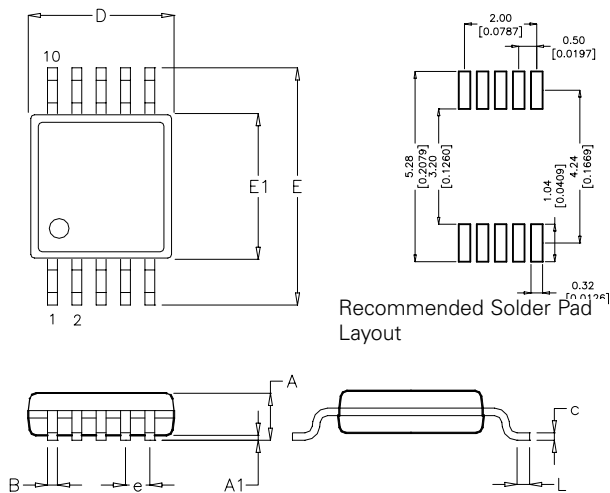

Package	MSOP10			
JEDEC	MO-187			
Pins	10			
Symbol	Millimeters		Inches	
	Min	Max	Min	Max
A	-	1.10	-	0.043
A1	0.00	0.15	0.000	0.006
B	0.17	0.27	0.007	0.011
c	0.08	0.23	0.003	0.009
D	2.90	3.10	0.114	0.122
E	4.67	5.10	0.184	0.200
E1	2.90	3.10	0.114	0.122
e	0.50 BSC		0.020 BSC	
HE	0.40	0.80	0.016	0.031

Package Dimensions — μ DFN-6L

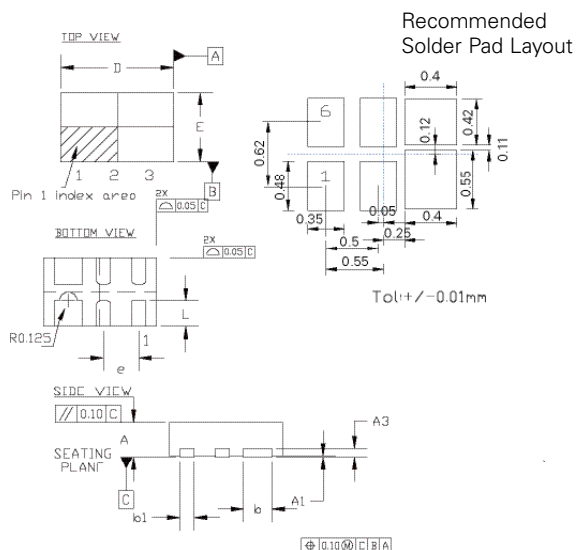

Package	μ DFN-6L			
JEDEC	MO-229			
Pins	6			
Symbol	Millimeters		Inches	
	Min	Max	Min	Max
A	0.45	0.55	0.018	0.022
A1	0.00	0.05	0.000	0.002
A3	0.125REF		0.005REF	
b	0.35	0.45	0.014	0.018
b1	0.15	0.25	0.006	0.010
D	1.55	1.65	0.062	0.065
D2	-	-	-	-
E	0.95	1.05	0.038	0.042
E2	-	-	-	-
e	0.50REF		0.020REF	
L	0.33	0.43	0.013	0.017

SP3003 Series

0.65pF Diode Array

Embossed Carrier Tape & Reel Specification — MSOP-10

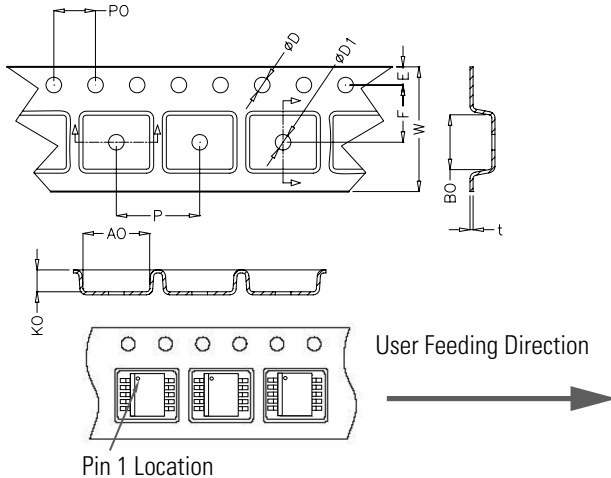

Symbol	Millimetres		Inches	
	Min	Max	Min	Max
E	1.65	1.85	0.065	0.073
F	5.40	5.60	0.213	0.220
D	1.50	1.60	0.059	0.063
D1	1.50 Min		0.059 Min	
P0	3.90	4.10	0.154	0.161
10P0	40.0± 0.20		1.574±0.008	
W	11.90	12.10	0.469	0.476
P	7.90	8.10	0.311	0.319
A0	5.20	5.40	0.205	0.213
B0	3.20	3.40	0.126	0.134
K0	1.20	1.40	0.047	0.055
t	0.30 ± 0.05		0.012± 0.002	

Embossed Carrier Tape & Reel Specifications — SC70-5 and SC70-6

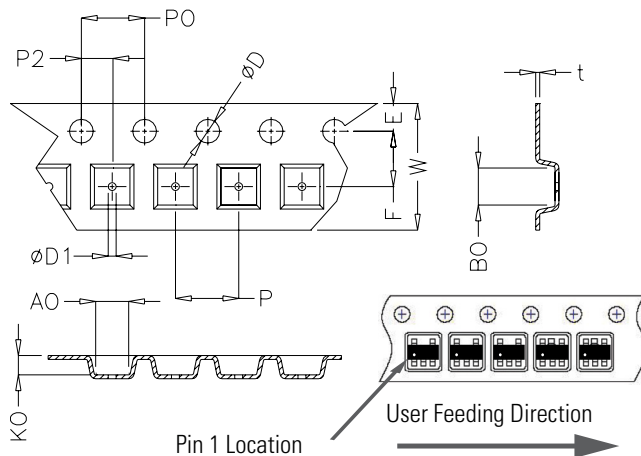

Symbol	Millimetres		Inches	
	Min	Max	Min	Max
E	1.65	1.85	0.064	0.073
F	3.45	3.55	0.135	0.139
P2	1.95	2.05	0.077	0.081
D	1.40	1.60	0.055	0.063
D1	1.00	1.25	0.039	0.049
P0	3.90	4.10	0.154	0.161
10P0	40.0± 0.20		1.574±0.008	
W	7.70	8.10	0.303	0.318
P	3.90	4.10	0.153	0.161
A0	2.14	2.34	0.084	0.092
B0	2.24	2.44	0.088	0.960
K0	1.12	1.32	0.044	0.052
t	0.27 max		0.010 max	

Embossed Carrier Tape & Reel Specifications — SOT553 and SOT563

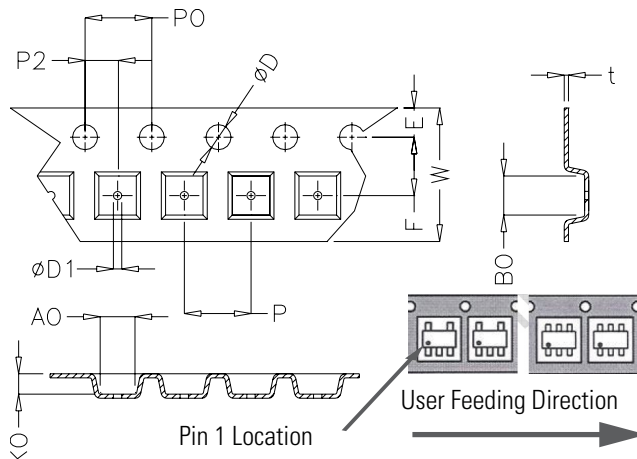

Symbol	Millimetres		Inches	
	Min	Max	Min	Max
E	1.65	1.85	0.064	0.073
F	3.45	3.55	0.135	0.139
P2	1.95	2.05	0.076	0.081
D	1.40	1.60	0.055	0.063
D1	0.45	0.55	0.017	0.021
P0	3.90	4.10	0.154	0.161
10P0	40.0± 0.20		1.574±0.008	
W	7.70	8.10	0.303	0.318
P	3.90	4.10	0.153	0.161
A0	1.73	1.83	0.068	0.072
B0	1.73	1.83	0.068	0.072
K0	0.64	0.74	0.025	0.029
t	0.22 max		0.009 max	

SP3003 Series

0.65pF Diode Array

Embossed Carrier Tape & Reel Specification — μDFN-6L

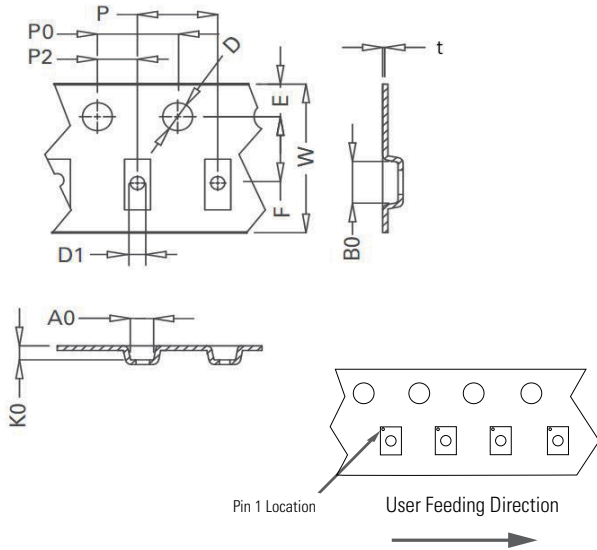

Symbol	Millimetres		Inches	
	Min	Max	Min	Max
E	1.65	1.85	0.064	0.073
F	3.45	3.55	0.135	0.139
P2	1.95	2.05	0.076	0.081
D	1.40	1.60	0.055	0.063
D1	0.45	0.55	0.017	0.021
P0	3.90	4.10	0.154	0.161
10P0	40.0±0.20		1.574±0.008	
W	7.90	8.30	0.311	0.319
P	3.90	4.10	0.154	0.161
A0	1.15	1.25	0.045	0.049
B0	1.75	1.85	0.069	0.073
K0	0.65	0.75	0.026	0.03
t	0.22 max		0.009 max	

Part Marking System

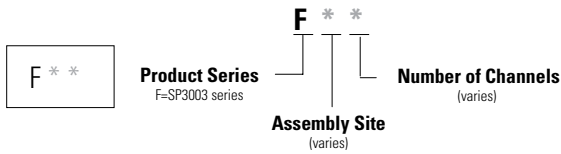

Ordering Information

Part Number	Package	Marking	Min. Order Qty.
SP3003-02JTG	SC70-5	F*2	3000
SP3003-02UTG	μDFN-6L	F*2	3000
SP3003-02XTG	SOT553	F*2	3000
SP3003-04ATG	MSOP-10	F*4	4000
SP3003-04JTG	SC70-6	F*4	3000
SP3003-04XTG	SOT563	F*4	3000
SP3003-08ATG	MSOP-10	F*8	4000

Part Numbering System

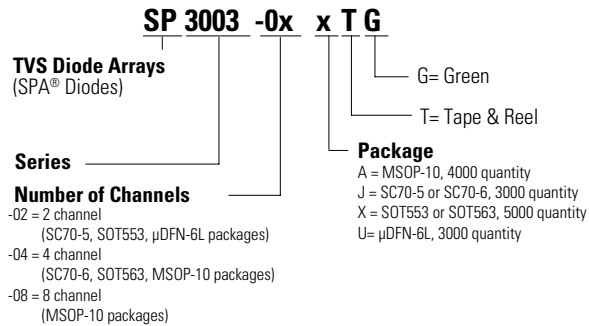

Disclaimer Notice - Information furnished is believed to be accurate and reliable. However, users should independently evaluate the suitability of and test each product selected for their own applications. Littelfuse products are not designed for, and may not be used in, all applications. Read complete Disclaimer Notice at <http://www.littelfuse.com/disclaimer-electronics>.