

# SP1064 Series

## General Purpose ESD Protection, 8.5pF, 15 kV Diode Array



### Description

The SP1064 is an avalanche breakdown diode fabricated in a proprietary silicon avalanche technology protect each I/O pin to provide a high level of protection for electronic equipment that may experience destructive electrostatic discharges (ESD). These robust diodes can safely absorb repetitive ESD strikes above the maximum level specified in IEC 61000-4-2 international standard (Level 4, ±8kV contact discharge) without performance degradation. Their very low loading capacitance also makes them ideal for protecting high speed signal pins.

### Features & Benefits

- ESD, IEC 61000-4-2, ±15kV contact, ±20kV air
- EFT, IEC 61000-4-4, 40A (5/50ns)
- Lightning, 2A (8/20µs as defined in IEC 61000-4-5, 2nd Edition)
- Low capacitance of 8.5pF (TYP) per I/O
- Low leakage current of 0.05µA (TYP) at 60V
- Small form factor µDFN( JEDEC MO-229) package saves board space
- Lead free and RoHS compliant
- AEC-Q101 qualified

### Additional Information



Resources



Accessories



Samples

### Pinout

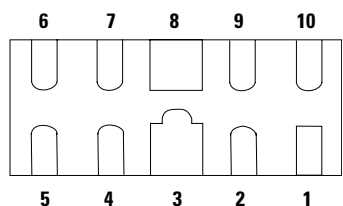

### Functional Block Diagram

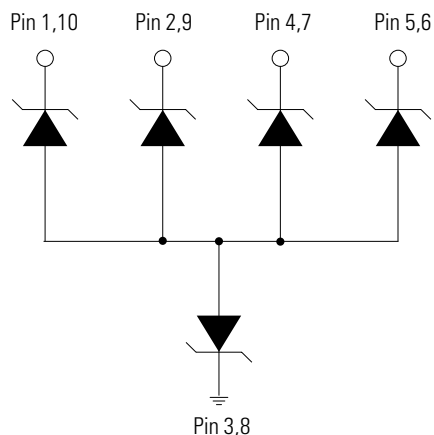

Life Support Note:

#### Not Intended for Use in Life Support or Life Saving Applications

The products shown herein are not designed for use in life sustaining or life saving applications unless otherwise expressly indicated.

### Applications

- LCD/PDP TVs
- DVD Players
- Desktops
- MP3/PMP
- Set Top Boxes
- Mobile Phones
- Notebooks
- Digital Cameras

### Application Example

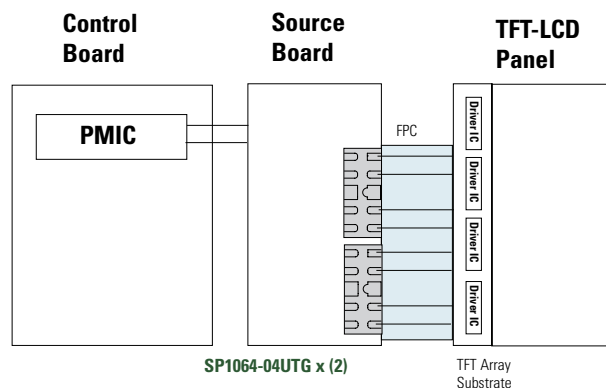

# SP1064 Series

## General Purpose ESD Protection, 8.5pF, 15 kV Diode Array

### Absolute Maximum Ratings

Symbol	Parameter	Value	Units
$I_{PP}$	Peak Current ( $t_p=8/20\mu s$ )	2.0	A
$T_{OP}$	Operating Temperature	-40 to 125	°C
$T_{STOR}$	Storage Temperature	-55 to 150	°C

**Caution:** Stresses above those listed in "Absolute Maximum Ratings" may cause permanent damage to the component. This is a stress only rating and operation of the component at these or any other conditions above those indicated in the operational sections of this specification is not implied.

### Electrical Characteristics ( $T_{OP}=25^\circ C$ )

Parameter	Symbol	Test Conditions	Min	Typ	Max	Units
Reverse Standoff Voltage	$V_{RWM}$	$I_R \leq 1\mu A$			60	V
Reverse Leakage Current	$I_{LEAK}$	$V_R=60V$ , Any I/O to GND		0.05		$\mu A$
Clamp Voltage <sup>1</sup>	$V_C$	$I_{PP}=1A$ , $t_p=8/20\mu s$ , Fwd		81		V
		$I_{PP}=2A$ , $t_p=8/20\mu s$ , Fwd		95		V
Dynamic Resistance <sup>3</sup>	$R_{DYN}$	TLP, $t_p=100ns$ , I/O to GND		4		$\Omega$
ESD Withstand Voltage <sup>1</sup>	$V_{ESD}$	IEC 61000-4-2 (Contact)	$\pm 15$			kV
		IEC 61000-4-2 (Air)	$\pm 20$			kV
Line Capacitance <sup>1,2</sup>	$C_L$	Reverse Bias=0V; $f=1MHz$		8.5		pF

#### Notes:

- Parameter is guaranteed by design and/or component characterization.
- Test equipment accuracy  $\pm 50fF$ .
- Transmission Line Pulse (TLP) with 100ns width, 2ns rise time, and average window  $t1=70ns$  to  $t2=90ns$

#### 8/20 $\mu s$ Pulse Waveform

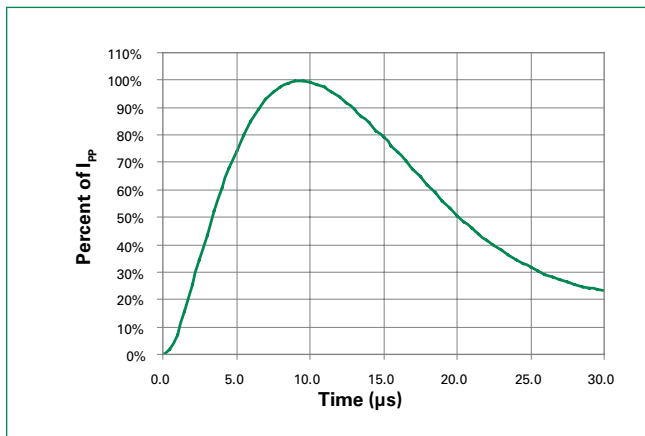

#### Capacitance vs. Reverse Bias

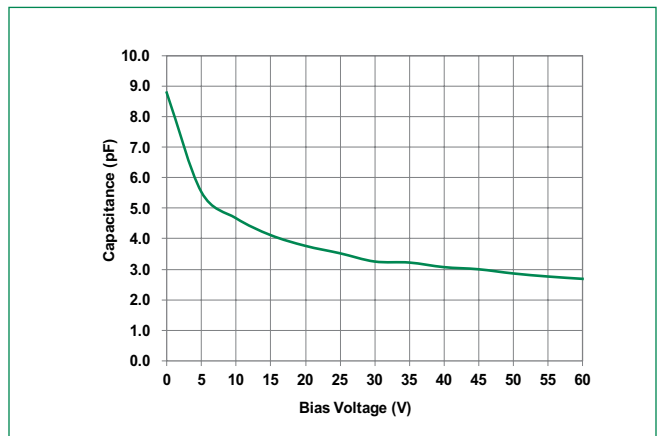

# SP1064 Series

## General Purpose ESD Protection, 8.5pF, 15 kV Diode Array

### Transmission Line Pulsing (TLP) Plot

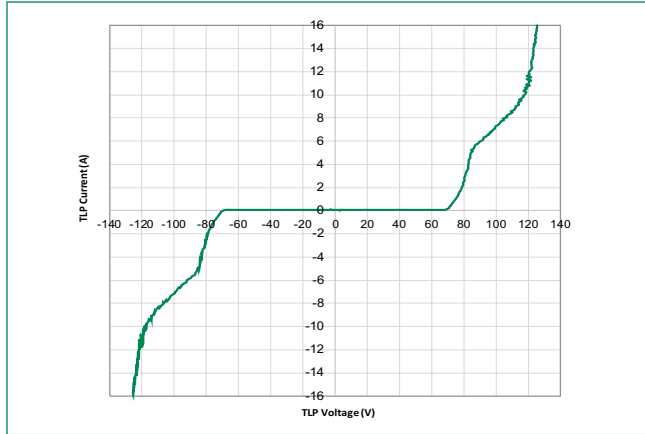

### Soldering Parameters

<b>Reflow Condition</b>		Pb – Free assembly
<b>Pre Heat</b>	- Temperature Min ( $T_{s(min)}$ )	150°C
	- Temperature Max ( $T_{s(max)}$ )	200°C
	- Time (min to max) ( $t_s$ )	60 – 120 secs
<b>Average ramp up rate (Liquidus) Temp (<math>T_L</math>) to peak</b>		3°C/second max
<b><math>T_{s(max)}</math> to <math>T_L</math> - Ramp-up Rate</b>		3°C/second max
<b>Reflow</b>	- Temperature ( $T_L$ ) (Liquidus)	217°C
	- Temperature ( $t_L$ )	60 – 150 seconds
<b>Peak Temperature (<math>T_p</math>)</b>		260 <sup>+0/-5</sup> °C
<b>Time within 5°C of actual peak Temperature (<math>t_p</math>)</b>		30 seconds
<b>Ramp-down Rate</b>		6°C/second max
<b>Time 25°C to peak Temperature (<math>T_p</math>)</b>		8 minutes Max.
<b>Do not exceed</b>		260°C

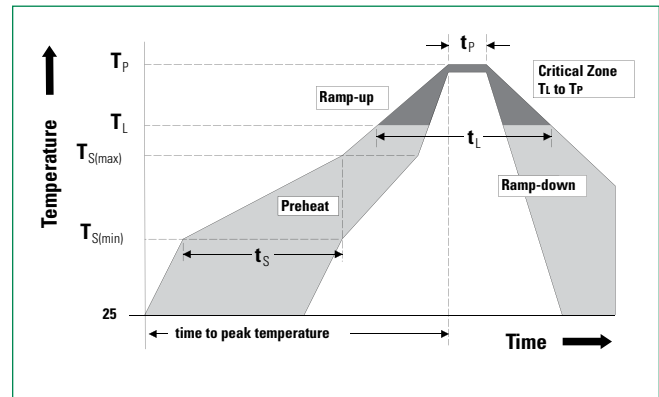

### Product Characteristics

<b>Lead Plating</b>	Tin
<b>Lead Material</b>	Copper Alloy
<b>Lead Coplanarity</b>	0.0004 inches (0.102mm)
<b>Substitute Material</b>	Silicon
<b>Body Material</b>	Molded Compound
<b>Flammability</b>	UL Recognized compound meeting flammability rating V-0

# SP1064 Series

## General Purpose ESD Protection, 8.5pF, 15 kV Diode Array

### Ordering Information

Part Number	Package	Min. Order Qty.
SP1064-04UTG	μDFN-10	3000

### Part Numbering System

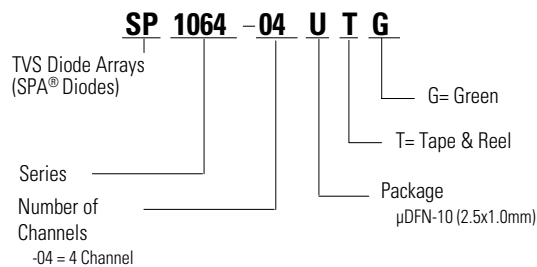

### Part Marking System

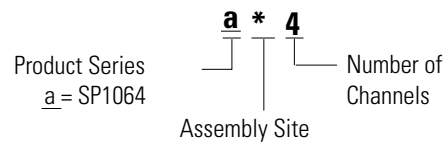

### Package Dimensions — μDFN-10 (2.5x1.0x0.5mm)

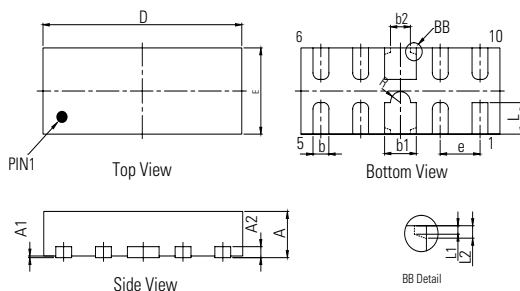

Package	μDFN-10 (2.5x1.0x0.5mm)			
JEDEC	MO-229			
Symbol	Millimeters		Inches	
	Min	Max	Min	Max
A	0.45	0.60	0.018	0.024
A1	0.00	0.05	0.000	0.002
A2	0.10	0.20	0.004	0.008
b	0.15	0.25	0.006	0.010
b1	0.35	0.45	0.014	0.018
b2	0.25 REF (Optional)		0.010 REF (Optional)	
D	2.40	2.60	0.098	0.106
E	0.90	1.10	0.037	0.045
L	0.28	0.48	0.011	0.019
e	0.50 BSC		0.020 BSC	
R	0.05	0.15	0.002	0.006

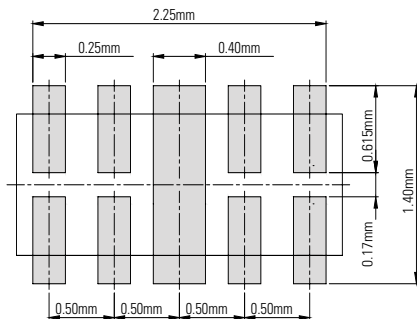

Recommended Soldering Layout

# SP1064 Series

## General Purpose ESD Protection, 8.5pF, 15 kV Diode Array

### Embossed Carrier Tape & Reel Specification — $\mu$ DFN-10

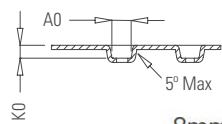
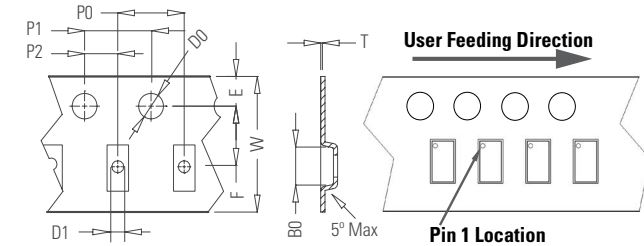

8mm TAPE AND REEL

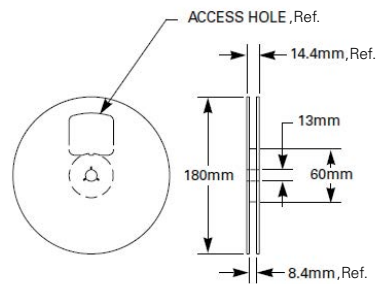

Package	$\mu$ DFN-10 (2.5x1.0x0.5mm)
Symbol	Millimeters
A0	1.30+0.10/-0.12
B0	2.83 +0.10/-0.18
D0	$\varnothing$ 1.50 + 0.10
D1	$\varnothing$ 1.00 + 0.25
E	1.75 +/- 0.10
F	3.50 +/- 0.05
K0	0.65 +/- 0.10
P0	4.00 +/- 0.10
P1	4.00 +/- 0.10
P2	2.00 +/- 0.05
T	0.254 +/- 0.02
W	8.00 + 0.30 /- 0.10

**Disclaimer Notice** - Littelfuse products are not designed for, and shall not be used for, any purpose (including, without limitation, automotive, military, aerospace, medical, life-saving, life-sustaining or nuclear facility applications, devices intended for surgical implant into the body, or any other application in which the failure or lack of desired operation of the product may result in personal injury, death, or property damage) other than those expressly set forth in applicable Littelfuse product documentation. Warranties granted by Littelfuse shall be deemed void for products used for any purpose not expressly set forth in applicable Littelfuse documentation. Littelfuse shall not be liable for any claims or damages arising out of products used in applications not expressly intended by Littelfuse as set forth in applicable Littelfuse documentation. The sale and use of Littelfuse products is subject to Littelfuse Terms and Conditions of Sale, unless otherwise agreed by Littelfuse. "Littelfuse" includes Littelfuse, Inc., and all of its affiliate entities. <http://www.littelfuse.com/disclaimer-electronics>.