

SP1053 8.5pF 8kV 01005 DFN Plastic Unidirectional Discrete TVS



OBSOLETE DATE: 6/10/2020 PCN/ECN# ESU270-51
REPLACED BY: SP1021-01WTG



Pinout

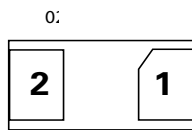

Note: Drawing not to scale

Functional Block Diagram



Description

Avalanche breakdown diodes fabricated in a proprietary silicon avalanche technology protect each I/O pin to provide a high level of protection for electronic equipment that may experience destructive electrostatic discharges (ESD). These robust diodes can safely absorb repetitive ESD strikes at $\pm 8\text{kV}$ (contact discharge, IEC 61000-4-2) without performance degradation. Additionally, each diode can safely withstand 1.0A surge (8/20 waveshape as defined in IEC 61000-4-5 2nd edition) at a very low clamping voltage.

Features

- ESD, IEC 61000-4-2, $\pm 8\text{kV}$ contact, $\pm 15\text{kV}$ air
- EFT, IEC 61000-4-4, 40A (5/50ns)
- Lightning, 1.0A (8/20 as defined in IEC 61000-4-5 2nd edition)
- Low capacitance of 8.5 pF (@ $V_R=0\text{V}$)
- Low leakage current of 0.02 μA (TYP) at 5V
- Unidirectional solutions presents half the dynamic resistance of a bidirectional device protects faster and better
- Industry's smallest ESD footprint available (01005 DFN plastic)
- Halogen free, Lead free and RoHS compliant
- Moisture Sensitivity Level (MSL -1)
- AEC-Q101 qualified

Applications

- Mobile Phones
- Smart Phones
- Camcorders
- Portable Medical
- Digital Cameras
- Wearable Technology
- Portable Navigation Components
- Tablets
- Point of Sale Terminals
- Identification Modules

Application Example

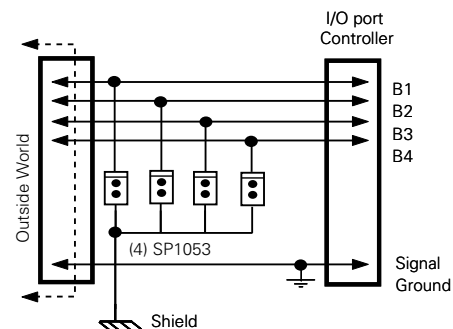

Life Support Note:

Not Intended for Use in Life Support or Life Saving Applications

The products shown herein are not designed for use in life sustaining or life saving applications unless otherwise expressly indicated.

Absolute Maximum Ratings

Symbol	Parameter	Value	Units
I_{PP}	Peak Current ($t_p=8/20\mu s$)	1.0 ¹	A
T_{OP}	Operating Temperature	-40 to 125	°C
T_{STOR}	Storage Temperature	-55 to 150	°C

Notes:

1. CAUTION: Stresses above those listed in "Absolute Maximum Ratings" may cause permanent damage to the component. This is a stress only rating and operation of the component at these or any other conditions above those indicated in the operational sections of this specification is not implied.

Electrical Characteristics ($T_{OP}=25^\circ C$)

Parameter	Symbol	Test Conditions	Min	Typ	Max	Units
Reverse Standoff Voltage	V_{RWM}				6.0	V
Breakdown Voltage	V_{BR}	$I_R=1mA$,	6.5	7.0		V
Leakage Current	I_{LEAK}	$V_R=5V$ with 1 pin at GND		0.02	0.5	μA
Clamp Voltage ¹	V_C	$I_{PP}=1A$, $t_p=8/20\mu s$, Fwd		9	12	V
Dynamic Resistance ²	R_{DYN}	TLP, $t_p=100ns$, I/O to GND		0.47		Ω
ESD Withstand Voltage ¹	V_{ESD}	IEC 61000-4-2 (Contact Discharge)	± 8			kV
		IEC 61000-4-2 (Air Discharge)	± 15			kV
Diode Capacitance ¹	C_D	Reverse Bias=0V		8.5		pF

Note:

1 Parameter is guaranteed by design and/or component characterization.

2. Transmission Line Pulse (TLP) with 100ns width, 2ns rise time, and average window $t_1=70ns$ to $t_2=90ns$

Capacitance vs. Reverse Bias

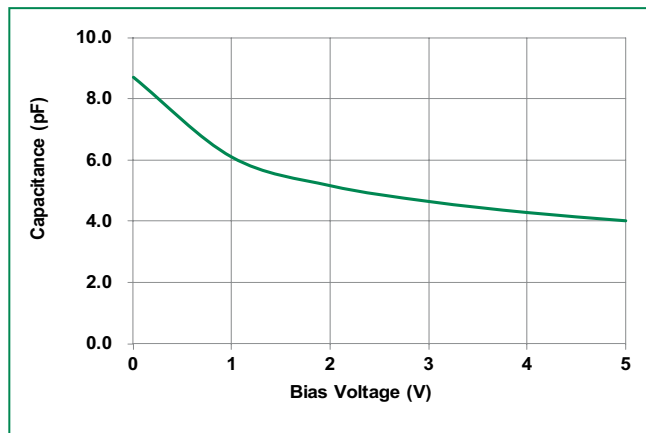

8/20 μs Pulse Waveform

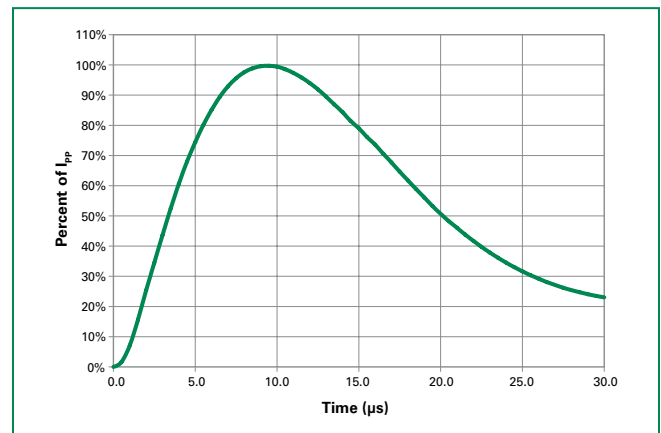

IEC 61000-4-2 +8 kV Contact ESD Clamping Voltage

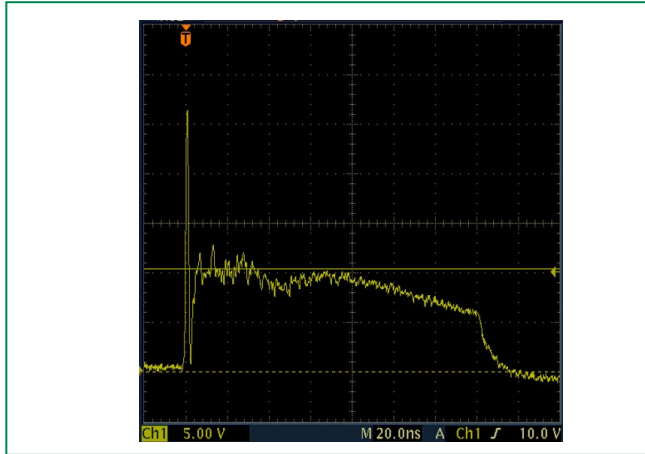

IEC 61000-4-2 -8 kV Contact ESD Clamping Voltage

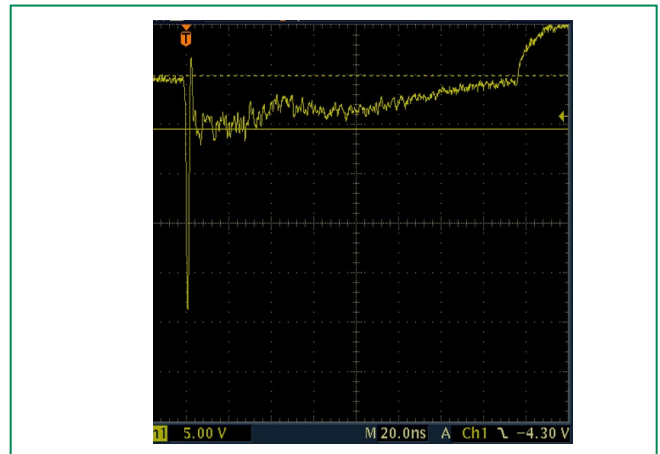

Positive Transmission Line Pulsing (TLP) Plot

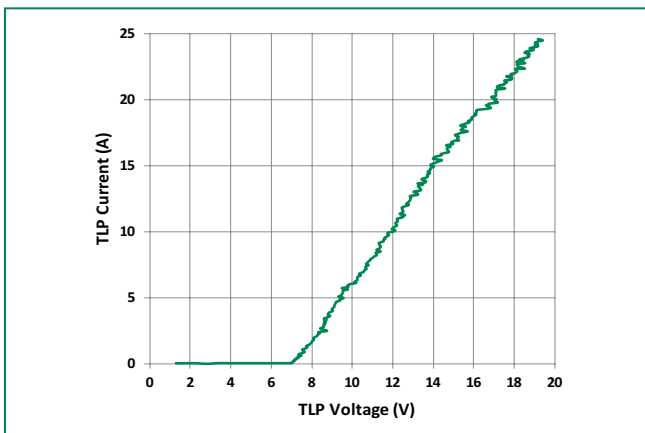

Negative Transmission Line Pulsing (TLP) Plot

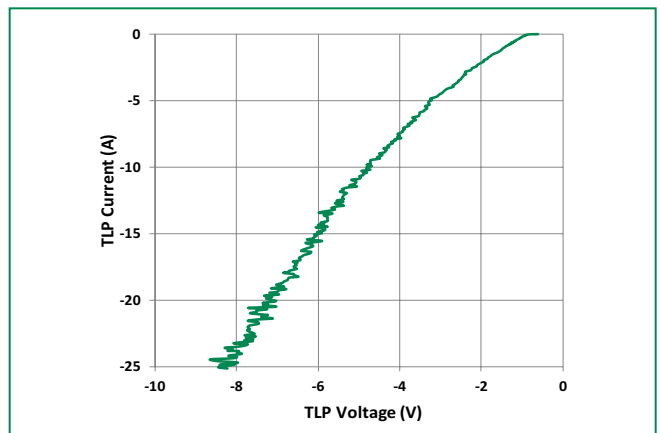

Soldering Parameters

Reflow Condition		Pb – Free assembly
Pre Heat	- Temperature Min ($T_{s(min)}$)	150°C
	- Temperature Max ($T_{s(max)}$)	200°C
	- Time (min to max) (t_s)	60 – 180 secs
Average ramp up rate (Liquidus) Temp (T_L) to peak		3°C/second max
$T_{s(max)}$ to T_L - Ramp-up Rate		3°C/second max
Reflow	- Temperature (T_L) (Liquidus)	217°C
	- Temperature (t_L)	60 – 150 seconds
Peak Temperature (T_p)		260 ^{+0/-5} °C
Time within 5°C of actual peak Temperature (t_p)		20 – 40 seconds
Ramp-down Rate		6°C/second max
Time 25°C to peak Temperature (T_p)		8 minutes Max.
Do not exceed		260°C

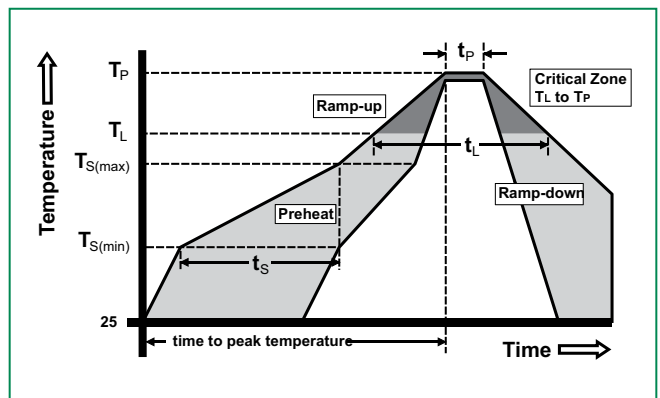

Product Characteristics

Lead Plating	Pre-Plated Frame
Lead Material	Copper Alloy
Substrate material	Silicon
Body Material	Molded Compound
Flammability	UL Recognized compound meeting flammability rating V-0.

Notes :

1. All dimensions are in millimeters
2. Dimensions include solder plating.
3. Dimensions are exclusive of mold flash & metal burr.

Part Numbering System

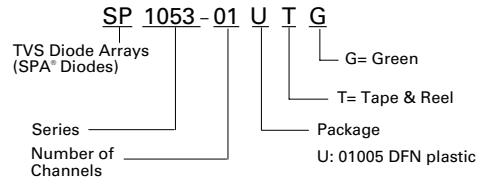

Part Marking System

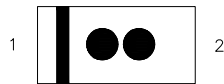

Ordering Information

Part Number	Package	Min. Order Qty.
SP1053-01UTG	01005 DFN plastic	20000

Package Dimensions — 01005 DFN plastic

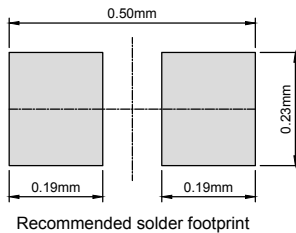
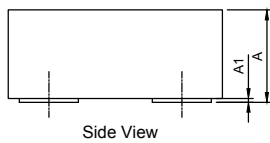
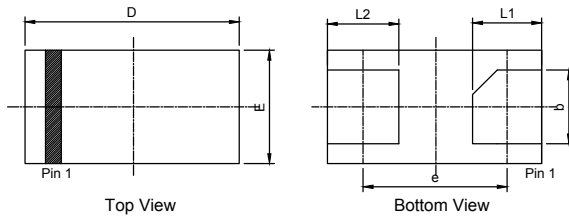

Symbol	01005 DFN					
	Millimeters			Inches		
	Min	Typ	Max	Min	Typ	Max
A	0.235	0.250	0.265	0.0093	0.0098	0.0104
A1	-	0.015	0.020	-	0.0006	0.0008
b	0.100	0.150	0.200	0.0039	0.0059	0.0079
D	0.385	0.435	0.485	0.0152	0.0171	0.0191
E	0.200	0.250	0.300	0.0079	0.0098	0.0118
e	0.293			0.0115		
L1	0.090	0.140	0.190	0.0035	0.0055	0.0075
L2	0.095	0.145	0.195	0.0037	0.0057	0.0077

Embossed Carrier Tape & Reel Specification – 01005 DFN plastic

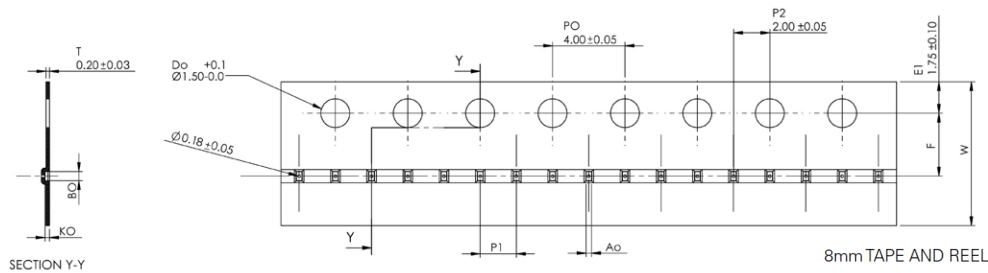

Symbol	Millimeters
A0	0.29 +0.02/-0.03
B0	0.505 +/-0.03
K0	0.275 +0.03/-0.10
F	3.5 +/- 0.05
P1	2.00 +/-0.05
W	8.00 +/-0.10

SECTION Y-Y

8mm TAPE AND REEL

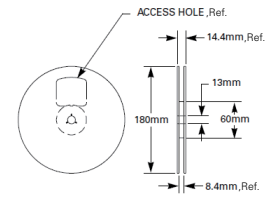
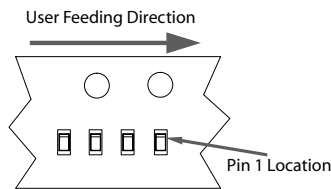

Disclaimer Notice - Information furnished is believed to be accurate and reliable. However, users should independently evaluate the suitability of and test each product selected for their own applications. Littelfuse products are not designed for, and may not be used in, all applications. Read complete Disclaimer Notice at <http://www.littelfuse.com/disclaimer-electronics>.