

# SP0504S Series

## 0.85pF Diode Array

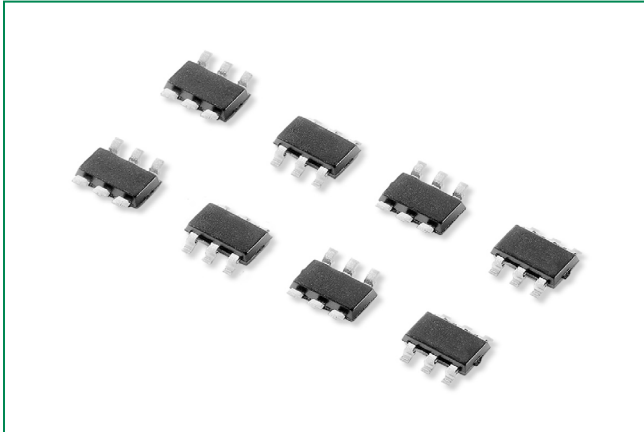

### Additional Information



Resources



Accessories



Samples

### Pinout

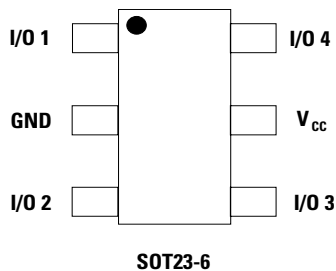

### Functional Block Diagram

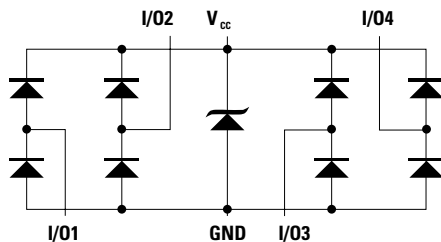

### Description

The SP0504S integrates low capacitance rail-to-rail diodes with an integrated proprietary avalanche breakdown diode that protects applications against ESD, EFT and low surge events. This component is rated for the maximum IEC 61000-4-2 ESD (level 4) contact and air discharge events. Their very low off-state capacitance also makes them ideal for protecting high speed signal pins such as HDMI, DVI, USB2.0, and IEEE 1394.

### Features & Benefits

- RoHS compliant and lead-free
- Low off-state capacitance of 0.85 pF (TYP) per I/O
- ESD rating of  $\pm 12$ kV contact discharge,  $\pm 15$ kV air discharge, (IEC 61000-4-2)
- EFT protection, IEC 61000-4-4, 40A (5/50ns)
- Low leakage current of  $0.5\mu\text{A}$  (MAX) at 5V
- Small packaging options saves board space
- Lightning, 4.5A (8/20 $\mu\text{s}$  as defined in IEC 61000-4-5 2nd edition)
- AEC-Q101 qualified

### Applications

- Computer Peripherals
- Mobile Phones
- PDAs
- Digital Cameras
- Network Hardware/Ports
- Test Equipment
- Medical Equipment
- Automotive Network

### Application Example

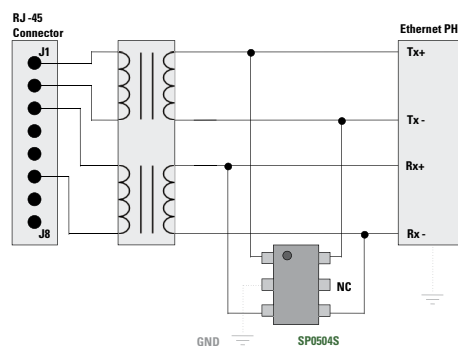

A single 4 channel SP0504S component can be used to protect four of the data lines in a HDMI/DVI interface. Two (2) SP0504S components provide protection for the main data lines. Low voltage ASIC HDMI/DVI drivers can also be protected with the SP0504S, the +VCC pins on the SP0504S can be substituted with a suitable bypass capacitor or in some backdrive applications the +VCC of the SP0504S can be floated or NC.

Life Support Note:

#### Not Intended for Use in Life Support or Life Saving Applications

The products shown herein are not designed for use in life sustaining or life saving applications unless otherwise expressly indicated.

# SP0504S Series

## 0.85pF Diode Array

### Absolute Maximum Ratings

Symbol	Parameter	Value	Units
$I_{PP}$	Peak Current ( $t_p=8/20\mu s$ )	4.5	A
$T_{OP}$	Operating Temperature	-40 to 125	°C
$T_{STOR}$	Storage Temperature	-55 to 150	°C

**Caution:** Stresses above those listed in "Absolute Maximum Ratings" may cause permanent damage to the component. This is a stress only rating and operation of the component at these or any other conditions above those indicated in the operational sections of this specification is not implied.

### Electrical Characteristics ( $T_{OP}=25^{\circ}C$ )

Parameter	Symbol	Test Conditions	Min	Typ	Max	Units
Reverse Standoff Voltage	$V_{RWM}$	$I_R = 1\mu A$	-	-	6.0	V
Reverse Leakage Current	$I_{LEAK}$	$V_R=5V$	-	-	0.5	$\mu A$
Breakdown Voltage	$V_{BR}$	$I_R=1mA$	6.3	8	8.8	V
Clamp Voltage <sup>1</sup>	$V_C$	$I_{PP}=1A, t_p=8/20\mu s, I/O$ to GND	-	9.5	11.0	V
		$I_{PP}=2A, t_p=8/20\mu s, I/O$ to GND	-	10.6	13.0	V
ESD Withstand Voltage <sup>1</sup>	$V_{ESD}$	IEC 61000-4-2 (Contact)	$\pm 12$	-	-	kV
		IEC 61000-4-2 (Air)	$\pm 15$	-	-	kV
Diode Capacitance <sup>1</sup>	$C_{I/O-GND}$	Reverse Bias=0V, f=1MHz	0.95	1.1	1.25	pF
		Reverse Bias=1.65V, f=1MHz	0.7	0.85	1.0	pF
Diode Capacitance <sup>1</sup>	$C_{I/O-I/O}$	Reverse Bias=0V, f=1MHz	-	0.5	-	pF

**Note:** 1. Parameter is guaranteed by design and/or component characterization.

2. Transmission Line Pulse (TLP) with 100ns width, 2ns rise time, and average window  $t_1=70ns$  to  $t_2=90ns$

# SP0504S Series

## 0.85pF Diode Array

Insertion Loss (S21) I/O to GND

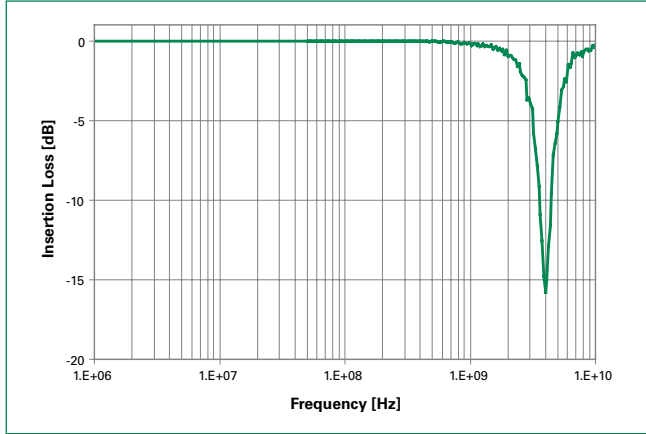

Capacitance vs. Bias Voltage

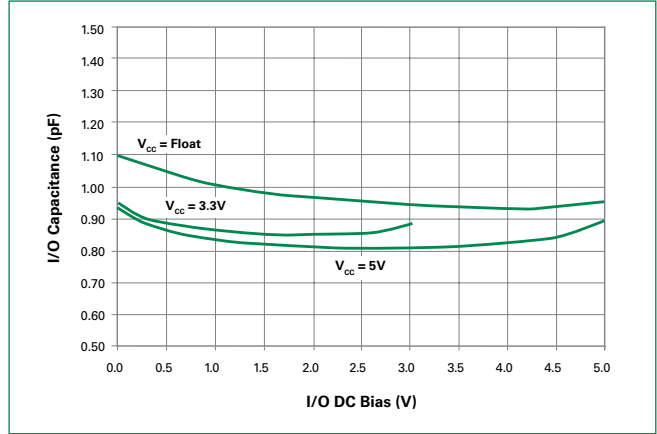

Capacitance vs. Frequency

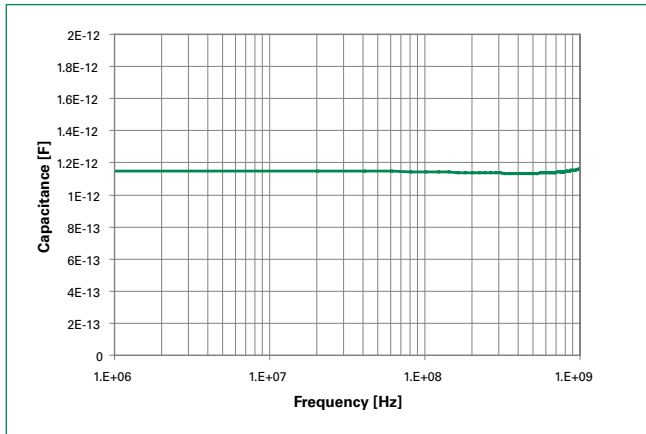

IEC 61000 -4-2 +8 kV Contact ESD Clamping Voltage

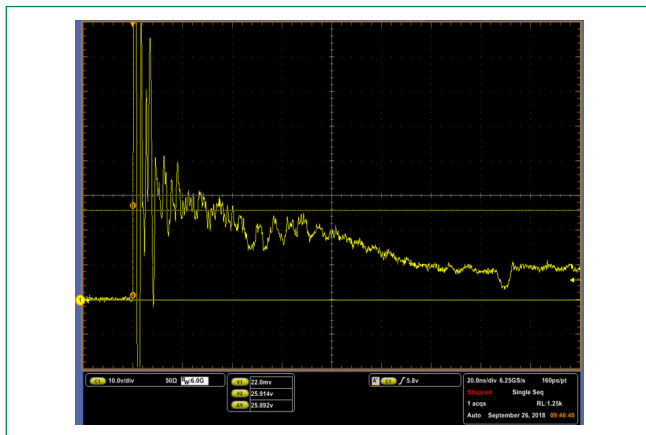

IEC 61000 -4-2 -8 kV Contact ESD Clamping Voltage

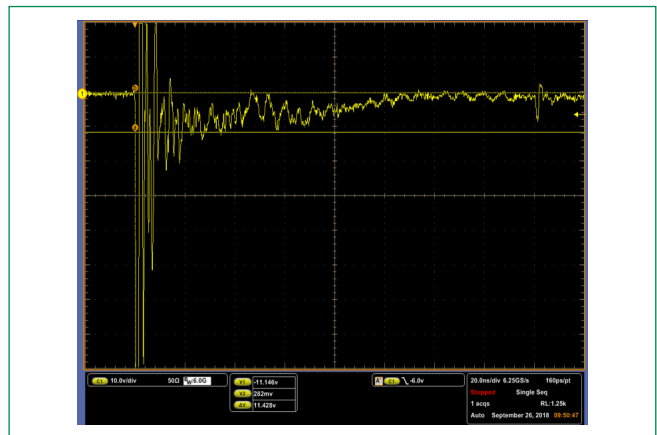

# SP0504S Series

## 0.85pF Diode Array

### Soldering Parameters

<b>Reflow Condition</b>		Pb – Free assembly
<b>Pre Heat</b>	- Temperature Min ( $T_{s(min)}$ )	150°C
	- Temperature Max ( $T_{s(max)}$ )	200°C
	- Time (min to max) ( $t_s$ )	60 – 120 secs
<b>Average ramp up rate (Liquidus) Temp (<math>T_L</math>) to peak</b>		3°C/second max
<b><math>T_{s(max)}</math> to <math>T_L</math> - Ramp-up Rate</b>		3°C/second max
<b>Reflow</b>	- Temperature ( $T_L$ ) (Liquidus)	217°C
	- Temperature ( $t_L$ )	60 – 150 seconds
<b>Peak Temperature (<math>T_p</math>)</b>		260 <sup>+0/-5</sup> °C
<b>Time within 5°C of actual peak Temperature (<math>t_p</math>)</b>		30 seconds
<b>Ramp-down Rate</b>		6°C/second max
<b>Time 25°C to peak Temperature (<math>T_p</math>)</b>		8 minutes Max.
<b>Do not exceed</b>		260°C

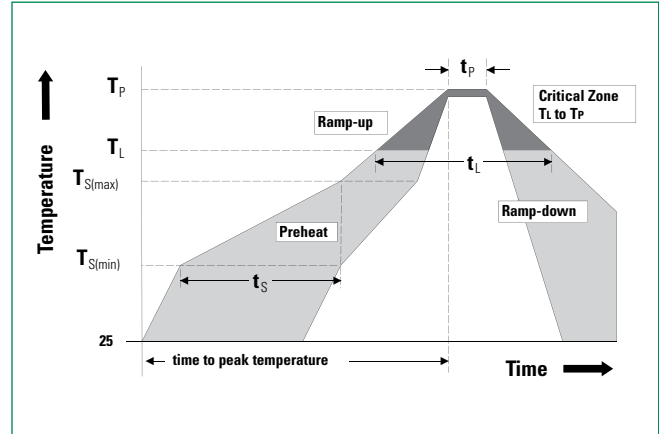

### Part Numbering System

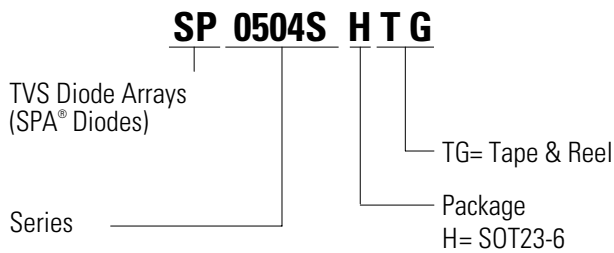

### Product Characteristics

<b>Lead Plating</b>	Matte Tin
<b>Lead Material</b>	Copper Alloy
<b>Lead Coplanarity</b>	0.0004 inches (0.102mm)
<b>Substitute Material</b>	Silicon
<b>Body Material</b>	Molded Compound
<b>Flammability</b>	UL Recognized compound meeting flammability rating V-0

### Part Marking System

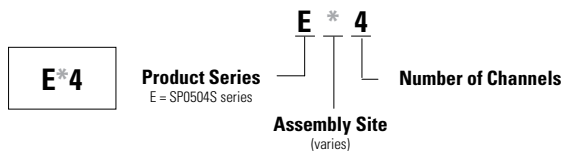

### Ordering Information

Part Number	Package	Min. Order Qty.
SP0504SHTG	SOT23-6	3000

# SP0504S Series

## 0.85pF Diode Array

### Package Dimensions – SOT23-6

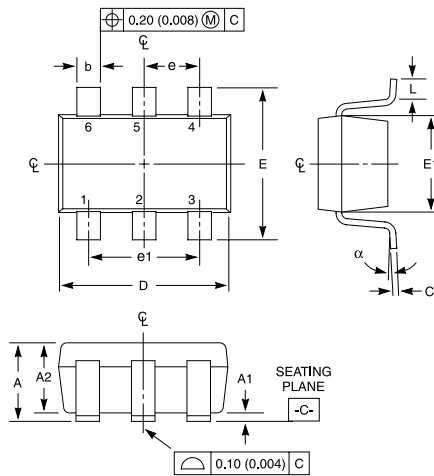

### Recommended Solder Pad Layout

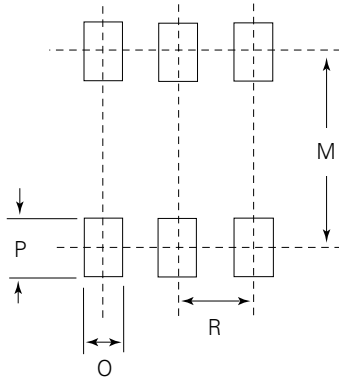

Package	SOT23				Notes
Pins	6				
JEDEC	MO-178AB				
	Millimeters		Inches		
	Min	Max	Min	Max	
A	0.900	1.450	0.035	0.057	-
A1	0.000	0.150	0.000	0.006	-
A2	0.900	1.300	0.035	0.051	-
b	0.250	0.500	0.0098	0.0196	-
C	0.080	0.220	0.0031	0.009	-
D	2.800	3.050	0.11	0.120	3
E	2.600	3.000	0.102	0.118	-
E1	1.500	1.750	0.06	0.069	3
e	0.95 Ref		0.0374 ref		-
e1	1.9 Ref		0.0748 Ref		-
L	0.30	0.600	0.012	0.023	4,5
N	6		6		6
alpha	0°	8°	0°	8°	-
M		2.590		0.102	-
O		0.690		.027 TYP	-
P		0.990		.039 TYP	-
R		0.950		0.038	-

#### Notes:

1. Dimensioning and tolerancing Per ASME Y14.5M-1994.
2. Package conforms to EIAJ SC-74 (1992).
3. Dimensions D and E1 are exclusive of mold flash, protrusions, or gate burrs.
4. Foot length L measured at reference to seating plane.
5. "L" is the length of flat foot surface for soldering to substrate.
6. "N" is the number of terminal positions.
7. Controlling dimension: MILLIMETER. Converted inch dimensions are not necessarily exact.

### Embossed Carrier Tape & Reel Specification – SOT23-6

#### 8mm Tape And Reel

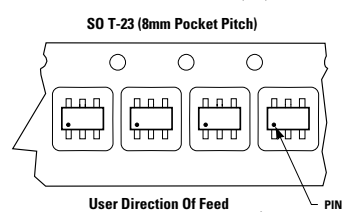
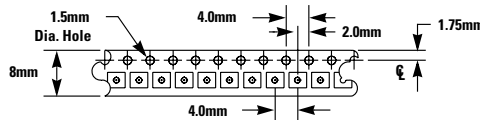
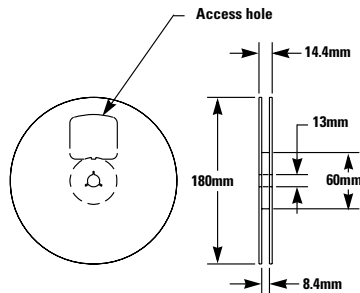

#### General Information

1. 3000 Pieces Per Reel.
2. Order In Multiples Of Full Reels Only.
3. Meets Eia-481 Revision "A" Specifications.

**Disclaimer Notice** - Information furnished is believed to be accurate and reliable. However, users should independently evaluate the suitability of and test each product selected for their own applications. Littelfuse products are not designed for, and may not be used in, all applications. Read complete Disclaimer Notice at [www.littelfuse.com/disclaimer-electronics](http://www.littelfuse.com/disclaimer-electronics).