

SP0115-01UTG

1 V Bidirectional Discrete TVS in DFN1610, General Purpose ESD Protection

HF **RoHS** **Pb**

Description

The SP0115-01UTG features low breakdown/turn on voltages, making them more ideal protectors of low voltage -1.0 to +1.0 V data lines. These robust diodes can safely absorb repetitive ESD strikes above the maximum level specified in IEC 61000-4-2 international standard (Level 4, ± 8 kV contact discharge) without performance degradation.

Pinout

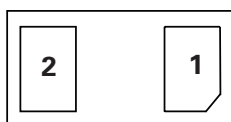

Features

- ESD, IEC 61000-4-2, ± 30 kV contact/air
- EFT, IEC 61000-4-4, 40 A (5/50 ns)
- Maximum surge tolerance, IEC 61000-4-5 2nd edition, 12 A (8/20 μ s)
- Halogen free, lead free and RoHS compliant
- Moisture sensitivity level (MSL-1)

Functional Block Diagram



Applications

- Low voltage GPIO for MCU
- Consumer
- Industry
- Medical

Life Support Note:

Not Intended for Use in Life Support or Life Saving Applications

The products shown herein are not designed for use in life sustaining or life saving applications unless otherwise expressly indicated.

SP0115-01UTG

1 V Bidirectional Discrete TVS in DFN1610, General Purpose ESD Protection

Absolute Maximum Ratings

Symbol	Parameter	Value	Units
I_{PP}	Peak Current ($t_p = 8/20 \mu s$)	12	A
T_{OP}	Operating Temperature	-40 to 125	°C
T_{STOR}	Storage Temperature	-55 to 150	°C

CAUTION: Stresses above those listed in "Absolute Maximum Ratings" may cause permanent damage to the component. This is a stress only rating and operation of the component at these or any other conditions above those indicated in the operational sections of this specification is not implied.

Electrical Characteristics ($T_{OP} = 25 \text{ }^\circ\text{C}$)

Parameter	Symbol	Test Conditions	Min	Typ	Max	Units
Reverse Standoff Voltage	V_{RWM}				1.0	V
Breakdown Voltage	V_{BR}	$I_R = 1 \text{ mA}$	1.4	1.6		V
Reverse Leakage Current	I_{LEAK}	$V_R = 1 \text{ V}$			1	μA
Clamp Voltage ¹	V_C	$I_{PP} = 1 \text{ A}$, $t_p = 8/20 \mu s$, I/O to GND		2.8		V
		$I_{PP} = 12 \text{ A}$, $t_p = 8/20 \mu s$, I/O to GND		8.9		V
Dynamic Resistance ²	R_{DYN}	TLP, $t_p = 100 \text{ ns}$, I/O to GND		0.26		Ω
ESD Withstand Voltage ^{1,3}	V_{ESD}	IEC 61000-4-2 (Contact Discharge)	± 30			kV
		IEC 61000-4-2 (Air Discharge)	± 30			kV
Diode Capacitance ¹	C_{IO-GND}	Reverse Bias = 0 V, $f = 1 \text{ MHz}$, I/O to GND		1		pF

Note:

- Parameter is guaranteed by design and/or component characterization.
- Transmission Line Pulse (TLP) with 100 ns width, 0.2 ns rise time, and average window $t_1 = 70 \text{ ns}$ to $t_2 = 90 \text{ ns}$.
- Device stressed with ten non-repetitive ESD pulses.

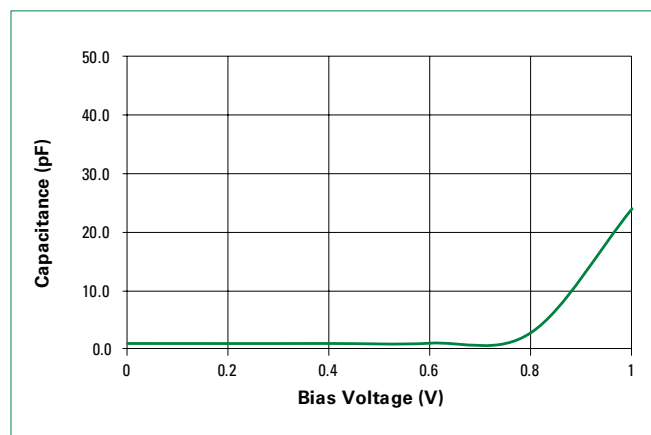
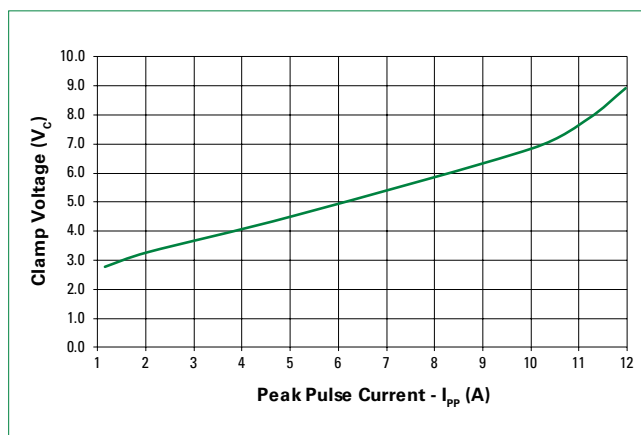
Capacitance vs. Reverse Bias**Clamping Voltage vs I_{PP}** 

SP0115-01UTG

1 V Bidirectional Discrete TVS in DFN1610, General Purpose ESD Protection

Positive Transmission Line Pulsing (TLP) Plot

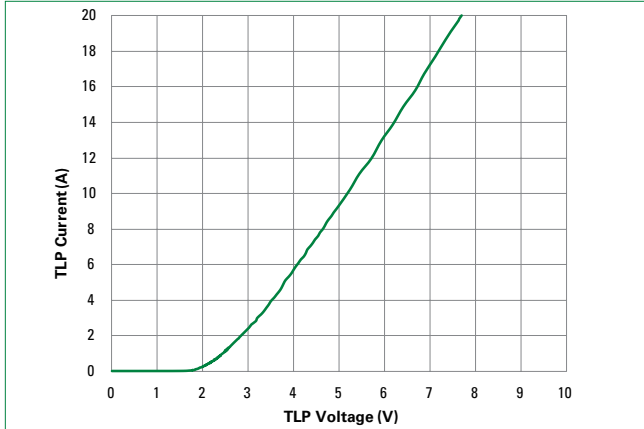

Negative Transmission Line Pulsing (TLP) Plot

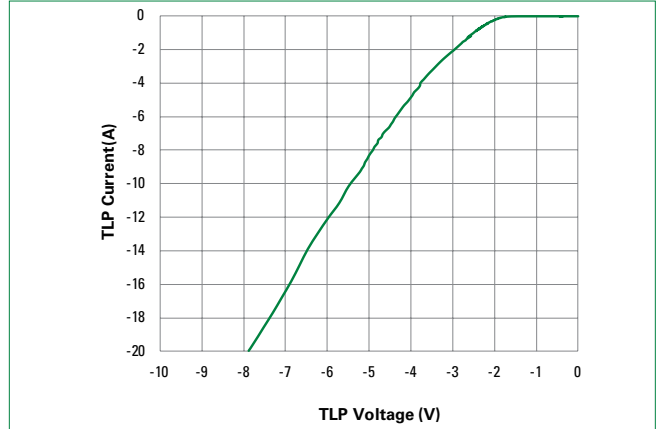

IEC 61000-4-2 +8 kV Contact ESD Clamping Voltage



IEC 61000-4-2 -8 kV Contact ESD Clamping Voltage

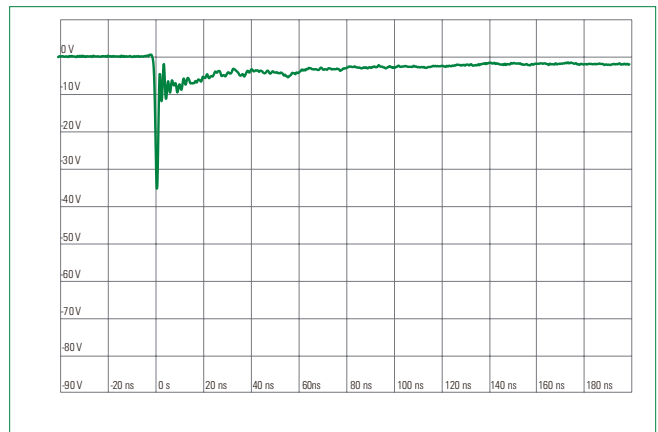

SP0115-01UTG

1 V Bidirectional Discrete TVS in DFN1610, General Purpose ESD Protection

Soldering Parameters

Reflow condition		Pb – Free assembly
Pre Heat	- Temperature min ($T_{s(min)}$)	150 °C
	- Temperature max ($T_{s(max)}$)	200 °C
	- Time (min to max) (t_s)	60 – 120 secs
Average ramp up rate (Liquidus) temp (T_L) to peak		3 °C/second max
$T_{s(max)}$ to T_L - Ramp-up rate		3 °C/second max
Reflow	- Temperature (T_L) (Liquidus)	217 °C
	- Temperature (t_L)	60 – 150 seconds
Peak temperature (T_p)		260 ^{+0/-5} °C
Time within 5 °C of actual peak temperature (t_p)		30 seconds
Ramp-down rate		6 °C/second max
Time 25 °C to peak temperature (T_p)		8 minutes max
Do not exceed		260 °C

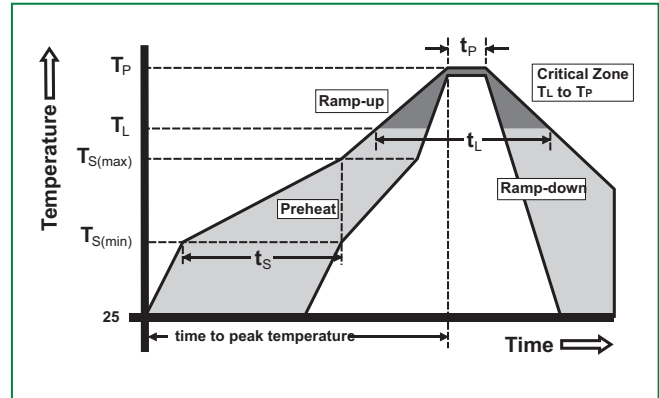

Ordering Information

Part Number	Package	Min. Order Qty.
SP0115-01UTG	1.6x1.0 mm DFN	3000

Product Characteristics

Lead plating	Matte tin
Lead material	Copper alloy
Body material	Molded compound
Flammability	UL recognized compound meeting flammability rating V-0

Part Marking System

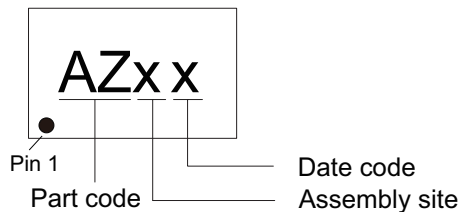

Part Numbering System

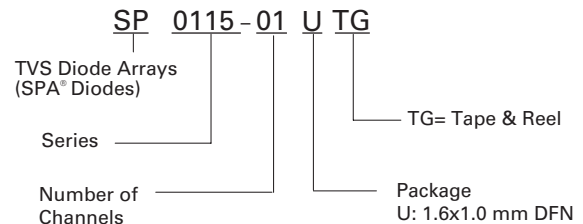

SP0115-01UTG

1 V Bidirectional Discrete TVS in DFN1610, General Purpose ESD Protection

Package Dimensions — 1610DFN

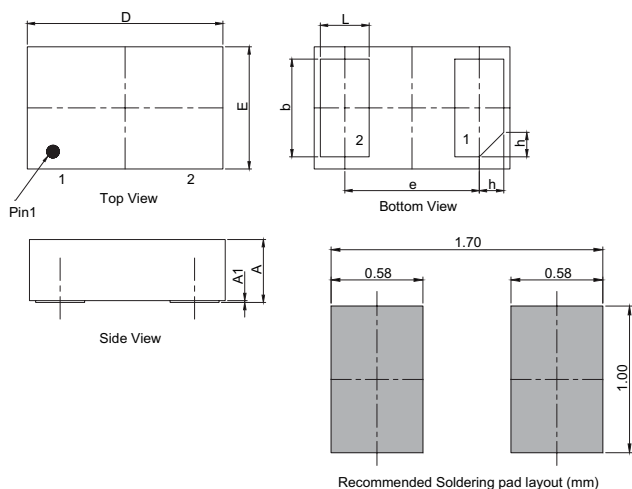

Symbol	1.6x1.0 mm DFN					
	Millimeters			Inches		
	Min	Typ	Max	Min	Typ	Max
A	0.45	0.50	0.55	0.018	0.020	0.022
A1	-	0.02	0.05	-	0.001	0.002
D	1.55	1.60	1.65	0.061	0.063	0.065
E	0.95	1.00	1.05	0.037	0.039	0.041
b	0.75	0.80	0.85	0.030	0.031	0.033
L	0.35	0.40	0.45	0.014	0.016	0.018
e	1.10 BSC			0.043 BSC		
h	0.15	0.20	0.25	0.006	0.008	0.010

Embossed Carrier Tape & Reel Specification — 1610DFN

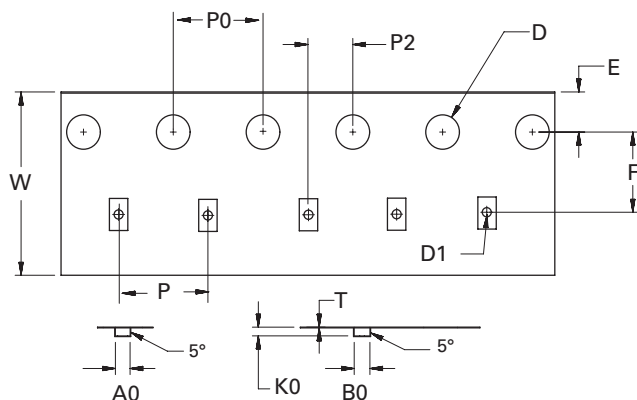

Symbol	Millimeters
A0	1.25 +/- 0.10
B0	1.80 +/- 0.10
D	Ø 1.50 + 0.1
D1	Ø 0.50 +/- 0.10
E	1.75 +/- 0.10
F	3.50 +/- 0.05
K0	0.80 +/- 0.10
P	4.00 +/- 0.10
P0	4.00 +/- 0.10
P2	2.00 +/- 0.05
T	0.23 +/- 0.05
W	8.00 +/- 0.10

Component Orientation in Tape

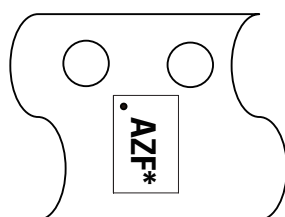

Access hole, ref.

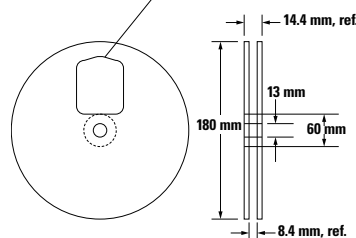

8mm Tape and Reel

Product Disclaimer: Littelfuse products are not designed for, and shall not be used for, any purpose (including, without limitation, automotive, military, aerospace, medical, life-saving, life-sustaining or nuclear facility applications, devices intended for surgical implant into the body, or any other application in which the failure or lack of desired operation of the product may result in personal injury, death, or property damage) other than those expressly set forth in applicable Littelfuse product documentation. Warranties granted by Littelfuse shall be deemed void for products used for any purpose not expressly set forth in applicable Littelfuse documentation. Littelfuse shall not be liable for any claims or damages arising out of products used in applications not expressly intended by Littelfuse as set forth in applicable Littelfuse documentation. The sale and use of Littelfuse products is subject to Littelfuse Terms and Conditions of Sale, unless otherwise agreed by Littelfuse. "Littelfuse" includes Littelfuse, Inc., and all of its affiliate entities. <http://www.littelfuse.com/disclaimer-electronics>.