

# AQ24CANFD

200W, General Purpose ESD Protection

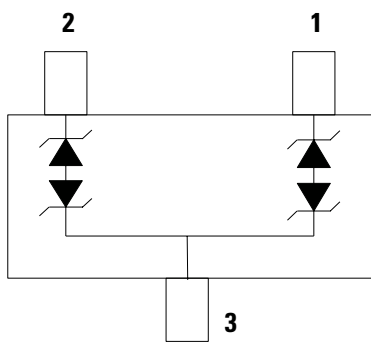

Pinout and Functional Block Diagram



## Description

The AQ24CANFD is designed to protect automotive Controller Area Network (CAN) lines from damage due to electrostatic discharge (ESD), electrical fast transient (EFT), and other overvoltage transients.

The AQ24CANFD can absorb repetitive ESD strikes above the maximum level specified in the IEC 61000-4-2 international standard without performance degradation and can safely withstand 3A surge (8/20µs waveshape as defined in IEC 61000-4-5 2nd edition) at a very low clamping voltages.

## Features & Benefits

- ESD, IEC 61000-4-2, ±21kV contact, ±21kV air
- EFT, IEC 61000-4-4, 50A (5/50ns)
- Lightning, IEC 61000-4-5 2nd edition, 3A (8/20µs)
- PPAP capable
- ESD, ISO 10605, 330pF 330Ω, ±21kV contact, ±21kV air
- Low clamping voltage
- Low leakage current
- AEC-Q101 qualified
- Moisture Sensitivity Level (MSL -1)
- Halogen free, lead free and RoHS compliant

## Applications

- CAN Bus Protection
- Automotive Applications
- Electronic Control Units
- Body Control Units
- ADAS Control Units
- PowerTrain Control Units
- Factory Automation
- Lightning Control (DALI)

## Application Example

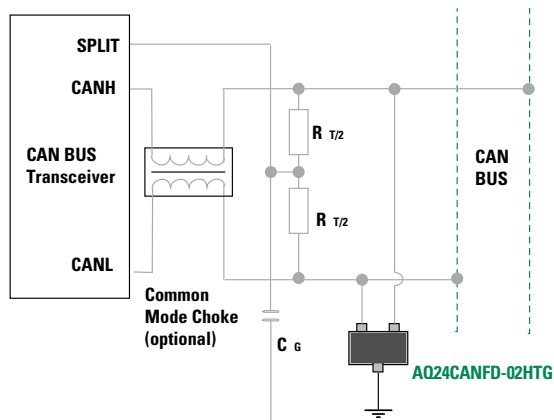

Life Support Note:

**Not Intended for Use in Life Support or Life Saving Applications**

The products shown herein are not designed for use in life sustaining or life saving applications unless otherwise expressly indicated.

**AQ24CANFD****200W, General Purpose ESD Protection****Absolute Maximum Ratings**

Symbol	Parameter	Value	Units
$P_{PK}$	Peak Pulse Power ( $t_p=8/20\mu s$ )	200	W
$I_{PP}$	Peak Pulse Current ( $t_p=8/20\mu s$ )	3.0	A
$T_{OP}$	Operating Temperature	-40 to 150	°C
$T_{STOR}$	Storage Temperature	-55 to 150	°C

**Caution:** Stresses above those listed in "Absolute Maximum Ratings" may cause permanent damage to the component. This is a stress only rating and operation of the component at these or any other conditions above those indicated in the operational sections of this specification is not implied.

**Electrical Characteristics ( $T_{OP}=25^\circ C$ )**

Parameter	Symbol	Test Conditions	Min	Typ	Max	Units
Reverse Standoff Voltage	$V_{RWM}$	$I_R=1\mu A$ , Pin1 or Pin2 to Pin3			24.0	V
Breakdown Voltage	$V_{BR}$	$I_R=1mA$ , Pin1 or Pin2 to Pin3	26.7	28.0		V
Reverse Leakage Current	$I_{LEAK}$	$V_R=24V$		0.02	0.5	$\mu A$
Clamp Voltage <sup>1</sup>	$V_C$	$I_{PP}=1A$ , $t_p=8/20\mu s$ , Pin 1 or Pin 2 to Pin 3		32.7	40.0	V
		$I_{PP}=3A$ , $t_p=8/20\mu s$ , Pin 1 or Pin 2 to Pin 3		41.2	50.0	V
Dynamic Resistance <sup>2</sup>	$R_{DYN}$	TLP, $t_p=100ns$ , I/O to GND		0.5		$\Omega$
ESD Withstand Voltage <sup>1</sup>	$V_{ESD}$	IEC 61000-4-2 (Contact Discharge)			$\pm 21$	kV
		IEC 61000-4-2 (Air Discharge)			$\pm 21$	kV
Diode Capacitance <sup>1</sup>	$C_{VO-GND}$	Reverse Bias=0V, $f=1MHz$ ; Pin 1 or Pin2 to Pin 3		11.5	14.0	pF

**Note:**

<sup>1</sup> Parameter is guaranteed by design and/or component characterization.

<sup>2</sup> Transmission Line Pulse (TLP) with 100ns width, 2ns rise time, and average window  $t_1=70ns$  to  $t_2=90ns$

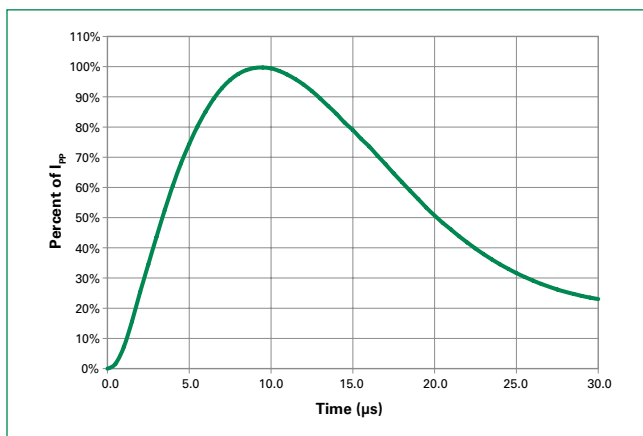
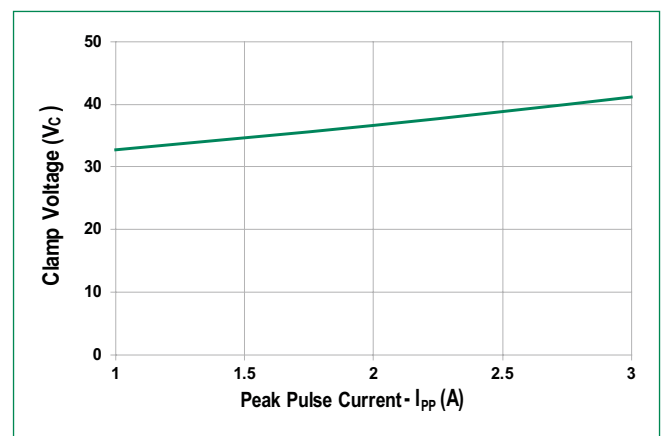
**8/20 $\mu s$  Pulse Waveform****Clamping Voltage vs IPP**

# AQ24CANFD

200W, General Purpose ESD Protection

Capacitance vs. Reverse Bias

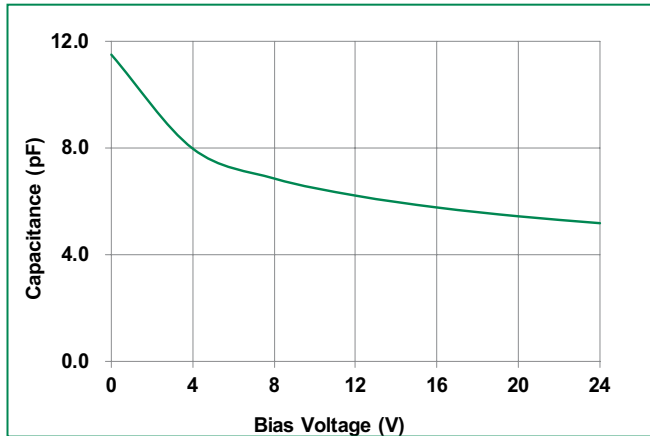

Transmission Line Pulsing(TLP) Plot

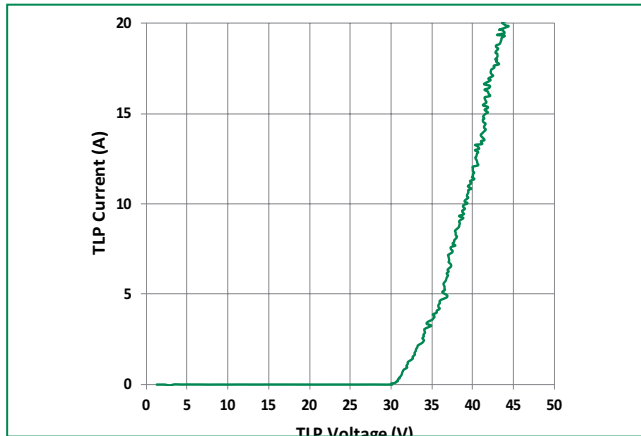

IEC 61000 -4-2 +8 kV Contact ESD Clamping Voltage

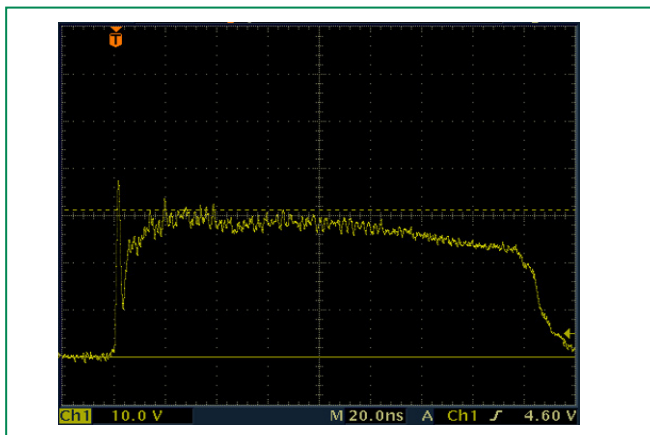

IEC 61000 -4-2 -8 kV Contact ESD Clamping Voltage

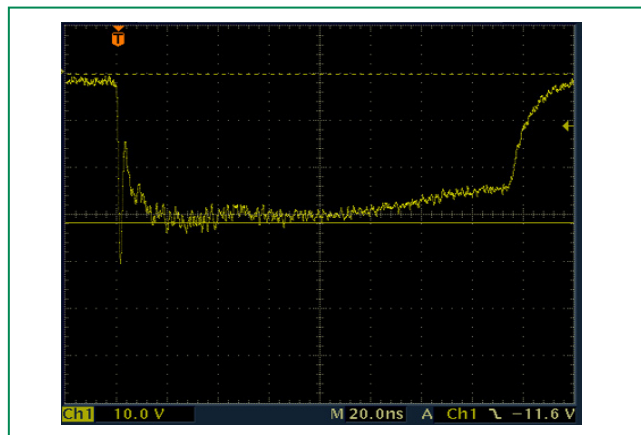

ISO10605 +8 kV Contact ESD Clamping Voltage

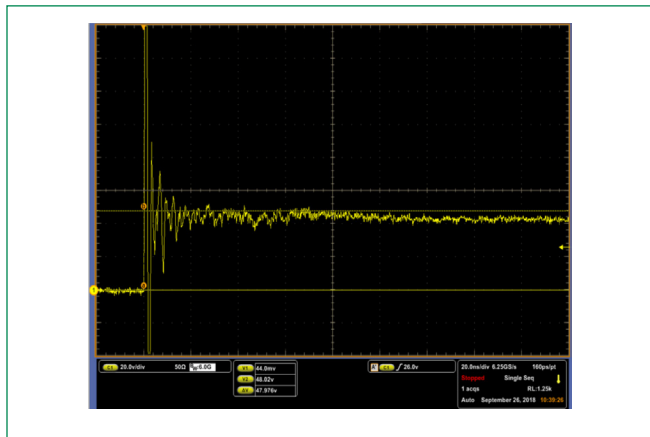

ISO10605 -8 kV Contact ESD Clamping Voltage

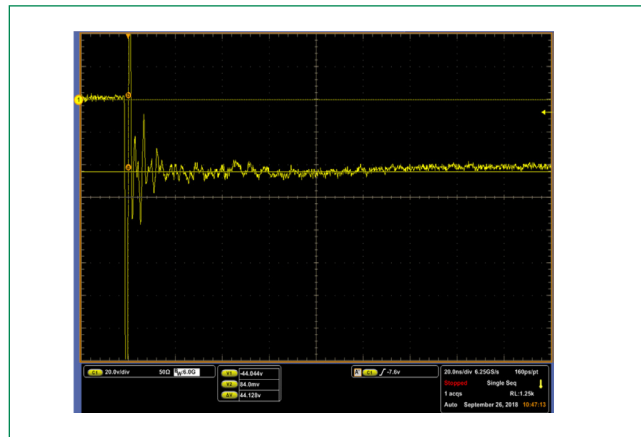

# AQ24CANFD

## 200W, General Purpose ESD Protection

### Soldering Parameters

<b>Reflow Condition</b>		Pb – Free assembly
<b>Pre Heat</b>	- Temperature Min ( $T_{s(min)}$ )	150°C
	- Temperature Max ( $T_{s(max)}$ )	200°C
	- Time (min to max) ( $t_s$ )	60 – 120 secs
<b>Average ramp up rate (Liquidus) Temp (<math>T_L</math>) to peak</b>		3°C/second max
<b><math>T_{s(max)}</math> to <math>T_L</math> - Ramp-up Rate</b>		3°C/second max
<b>Reflow</b>	- Temperature ( $T_L$ ) (Liquidus)	217°C
	- Temperature ( $t_L$ )	60 – 150 seconds
<b>Peak Temperature (<math>T_p</math>)</b>		260 <sup>+0/-5</sup> °C
<b>Time within 5°C of actual peak Temperature (<math>t_p</math>)</b>		30 seconds
<b>Ramp-down Rate</b>		6°C/second max
<b>Time 25°C to peak Temperature (<math>T_p</math>)</b>		8 minutes Max.
<b>Do not exceed</b>		260°C

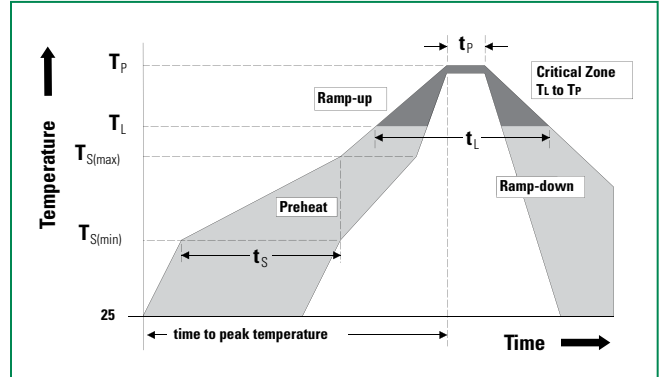

### Part Marking System

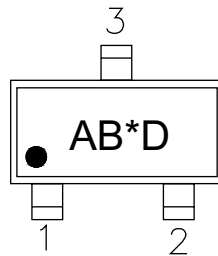

AB : Part code  
 \* : Assembly code  
 D : Date code

### Ordering Information

Part Number	Package	Min. Order Qty.
AQ24CANFD-02HTG	SOT23-3	3000

### Part Numbering System

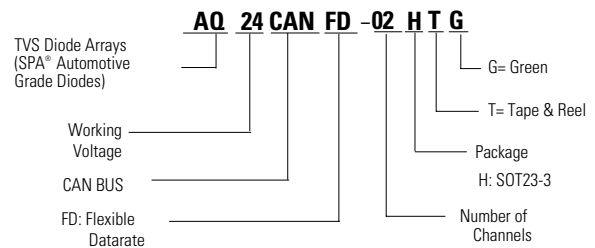

### Product Characteristics

<b>Lead Plating</b>	Matte Tin
<b>Lead Material</b>	Copper Alloy
<b>Lead Coplanarity</b>	0.004 inches(0.102mm)
<b>Substrate material</b>	Silicon
<b>Body Material</b>	Molded Compound
<b>Flammability</b>	UL Recognized compound meeting flammability rating V-0

**AQ24CANFD**

200W, General Purpose ESD Protection

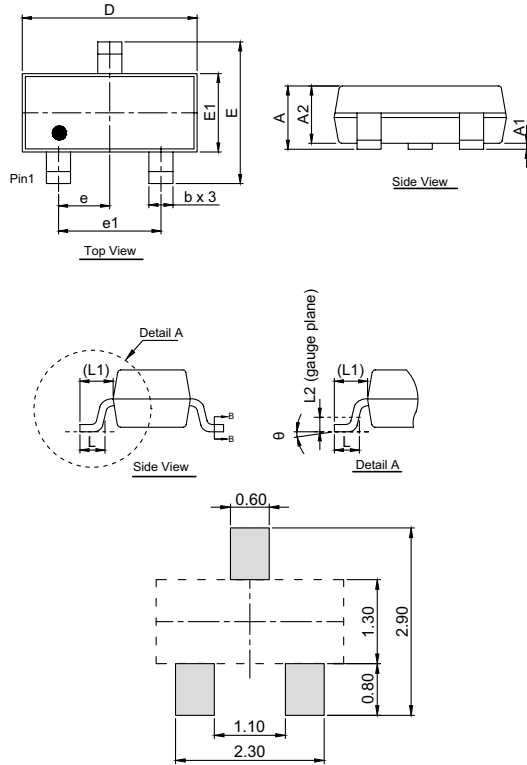
**Package Dimensions — SOT23-3**

Recommended soldering pad layout (unit :mm)

Symbol	Millimeters			Inches		
	Min	Nom	Max	Min	Nom	Max
A	0.89	-	1.17	0.035	-	0.046
A1	0.00	-	0.15	0.000	-	0.006
A2	0.88	0.95	1.02	0.035	0.037	0.040
D	2.80	2.90	3.04	0.110	0.114	0.120
E	2.10	2.35	2.64	0.083	0.093	0.104
E1	1.20	1.30	1.40	0.047	0.051	0.055
e	0.95 BSC			0.037BSC		
e1	1.90 BSC			0.075BSC		
L	0.28	0.44	0.60	0.011	0.017	0.024
L1	0.54 REF			0.021 REF		
L2	0.25 BSC			0.010 BSC		
θ	0°	-	8°	0°	-	8°

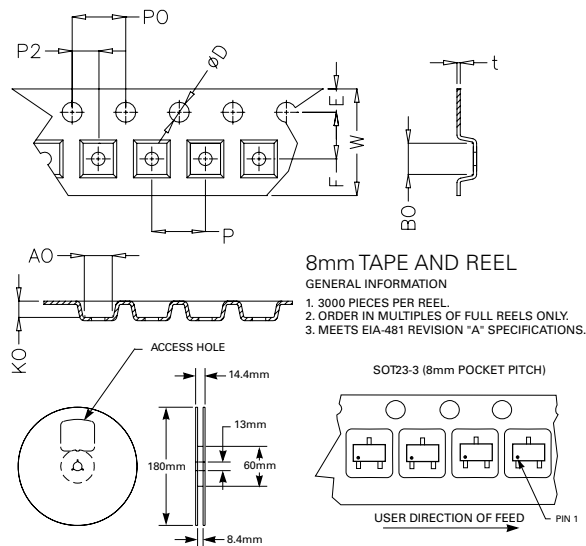
**Embossed Carrier Tape & Reel Specification — SOT23-3**

Symbol	Millimetres		Inches	
	Min	Max	Min	Max
E	1.65	1.85	0.065	0.073
F	3.40	3.60	0.134	0.142
P2	1.90	2.10	0.075	0.083
D	1.40	1.60	0.055	0.063
P0	3.90	4.10	0.154	0.161
W	7.70	8.30	0.303	0.327
P	3.90	4.10	0.154	0.161
A0	3.05	3.25	0.120	0.128
B0	2.67	2.87	0.105	0.113
K0	1.12	1.32	0.044	0.052
t	0.22	0.24	0.009	0.009

**Disclaimer Notice** - Information furnished is believed to be accurate and reliable. However, users should independently evaluate the suitability of and test each product selected for their own applications. Littelfuse products are not designed for, and may not be used in, all applications. Read complete Disclaimer Notice at <http://www.littelfuse.com/disclaimer-electronics>.