

P0080T023G5

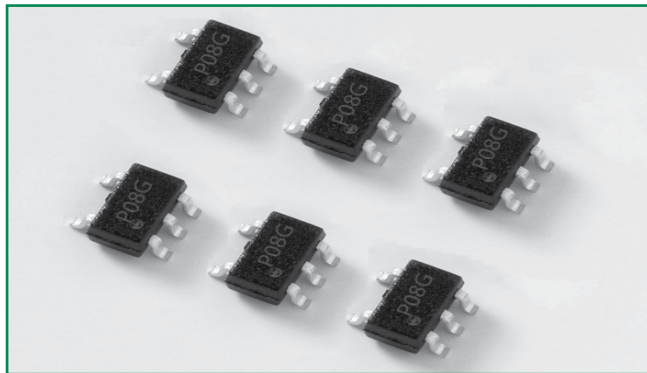

Description

This new P0080T023G5 is targeted for the tertiary or line driver side protection position for VDSL2+ and ADSL2+ applications. This new low capacitance over voltage protection does not require a bias voltage and is sufficiently robust for the chip-side position behind the coupling transformer. This SOT23-5 solution, with its flow-through design, minimizes PCB trace layout routing makes it compatible with a variety of line drivers. Its low capacitance makes it compatible with ADSL2 and VDSL2, and the 30MHz bandplan of VDSL2+.

Agency Approvals

Agency	Agency File Number
	E133083

Features & Benefits

- Lower overshoot protection than clamping
- SOT23-5 surface mount package
- Low insertion loss
- Low capacitance
- Bidirectional transient voltage protection
- Robust surge rating
- RoHS compliant
- 2nd level interconnect is Pb-free per IPC/JEDEC J-STD-609A.01

Schematic Symbol

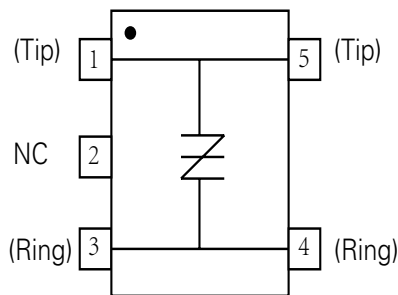

Protection solution to meet

- YD/T 950
- YD/T 993
- YD/T 1082
- GR 1089 Inter-building
- GR 1089 Intra-building
- IEC 61000-4-2
- IEC 61000-4-5
- ITU K.20/21 Basic Level
- ITU K.20/21 Enhanced Level
- TIA-968-A
- TIA-968-B

Additional Information



Datasheet



Resources



Samples

Surge Ratings

Series	I_{PP}	
	10x1000 μ s	8x20 μ s
G	Amps min 18	Amps min 50

Electrical Characteristics

Part Number	Marking	$V_{DRM} @ I_{DRM}=5\mu A$	$V_S @ 250V/\mu s$	I_H	I_S	I_T	$V_T @ I_T=2.2$ Amps	$C_o @ f=1MHz, 2V$	
		V min	V max	mA typ	mA max	A max	V max	pF typ	pF Max
P0080T023G5RP	P08G	8	15	30	500	2.2	4	9.0	10

Notes:

- All measurement are made at an ambient temperature of 25°C I_{pp} applies to -40°C through +85°C temperature range.
- I_{pp} is repetitive surge rating and is guaranteed for the life of the product.

- SIDACtor devices are bidirectional. All electrical parameters and surge rating apply to forward and reverse polarities.
- Specifications are subject to change without notice.

Maximum Ratings

Parameter Name	Symbol	Test Conditions	Value		Units
Lightning surge waveforms	I_{PP}	10x1000µs	18		A
		10x700µs/5x310µs	25		A
		1.2x50µs/8x20µs	50		A
		2x10µs	45		A
			min	max	
Operating Free Temperature Range	T_A		-40	+85	°C
Junction temperature	T_J		-40	+150	°C
Storage temperature	T_{STG}		-40	+150	°C

- Notes:
- The device also complies with IEC 61000-4-2 ESD ±15kV (air discharge), ±8 kV(contact discharge) and IEC 61000-4-4 EFT 40A(5/50nS)
 - The device must initially be in thermal equilibrium with -40°C ≤ T_J ≤ +150°C
 - The lightning surge may be repeated after the device returns to its initial conditions.

Mechanical dimensions, recommended layout dimensions

The epoxy meets UL 94V0 ratings.

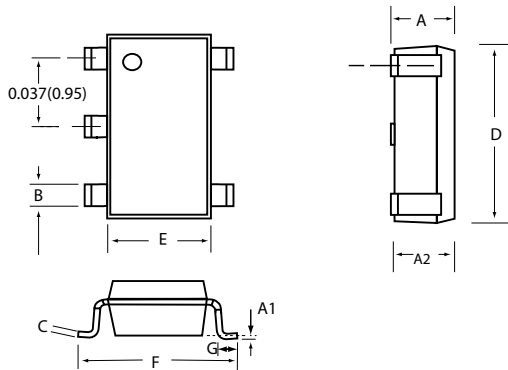

Dimension	Inches		Millimeters	
	Min	Max	Min	Max
A	0.035	0.057	0.90	1.45
A1	0.000	0.004	0.00	0.10
A2	0.035	0.051	0.90	1.30
B	0.014	0.020	0.35	0.50
C	0.004	0.008	0.09	0.20
D	0.110	0.118	2.80	3.00
E	0.059	0.069	1.50	1.75
F	0.102	0.118	2.60	3.00
G	0.004	0.024	0.10	0.60

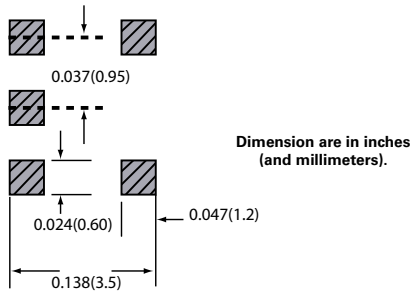

Dimension are in inches
(and millimeters).

Thermal Considerations

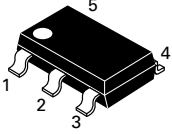
Package	Symbol	Parameter	Value	Unit
	T_J	Operating Junction Temperature Range	-40 to +150	°C
	T_{STG}	Storage Temperature Range	-40 to +150	°C
	$R_{\theta JA}$	Thermal Resistance: Junction to Ambient	120	°C/W

Holding Current vs. Case Temperature

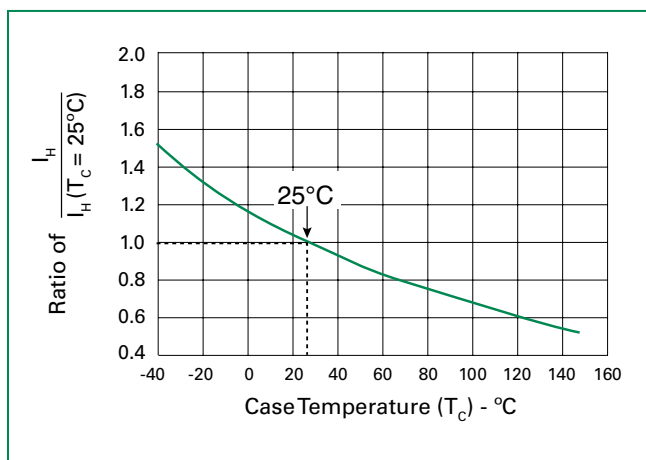

V_S vs. Junction Temperature

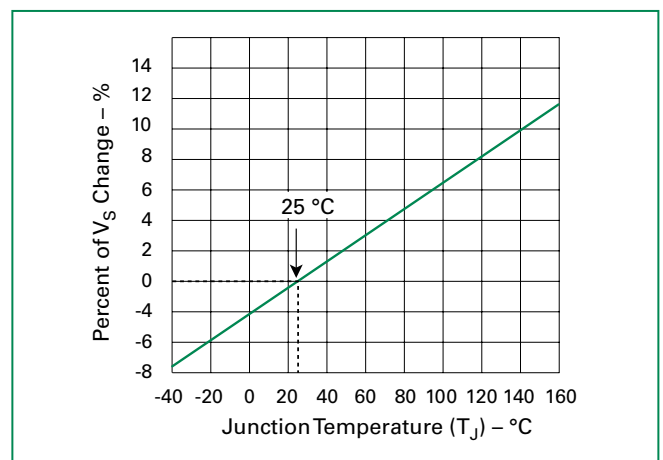

Capacitance vs. Bias Voltage*

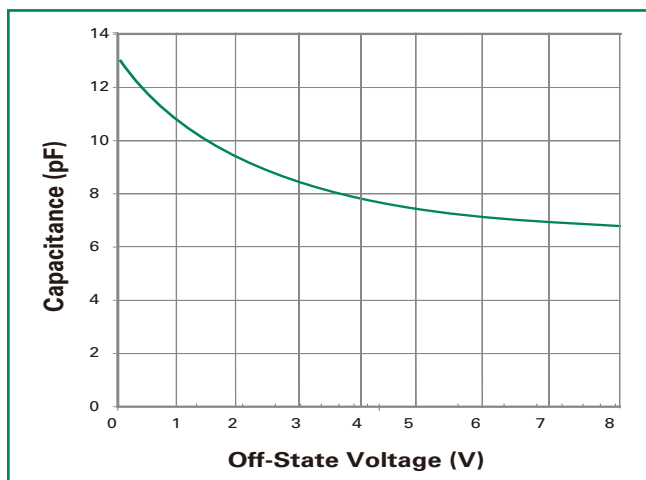

V-I Characteristics

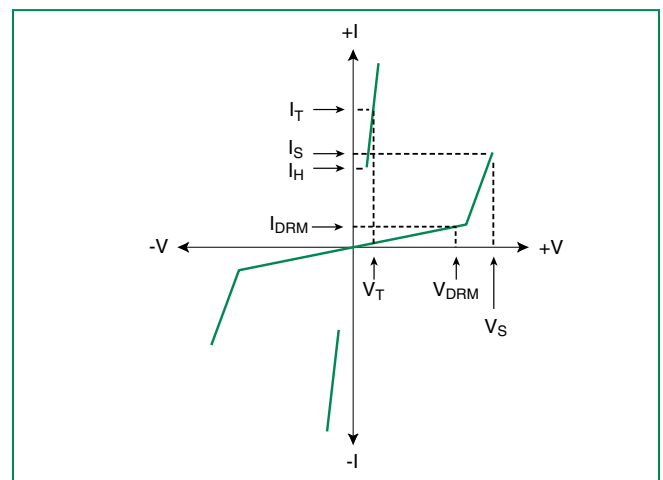

P0080T023G5 Application example

The following schematics show alternate protection solutions for a typical DSL interface that connects to outside wiring. This surface mount SOT23-5 chip-side solution provides a minimum footprint solution appropriate for high density card designs. The P0080T023G5 will protect the interface from lightning induced surges on the chip-side of the coupling transformer. This tertiary protector may be preceded by line-side protection such as the TeleLink over-current protector

and the P0080T023G5 overvoltage protector. GDTs may also be used on the line side of the coupling transformer. The flow-through design of the SOT23-5 package is illustrated below. If the inter winding capacitance of the transformer is allowing some common mode events to get coupled across, then the P0080T023G5 can be placed in a three chip mode, as shown below for additional chip-side protection.

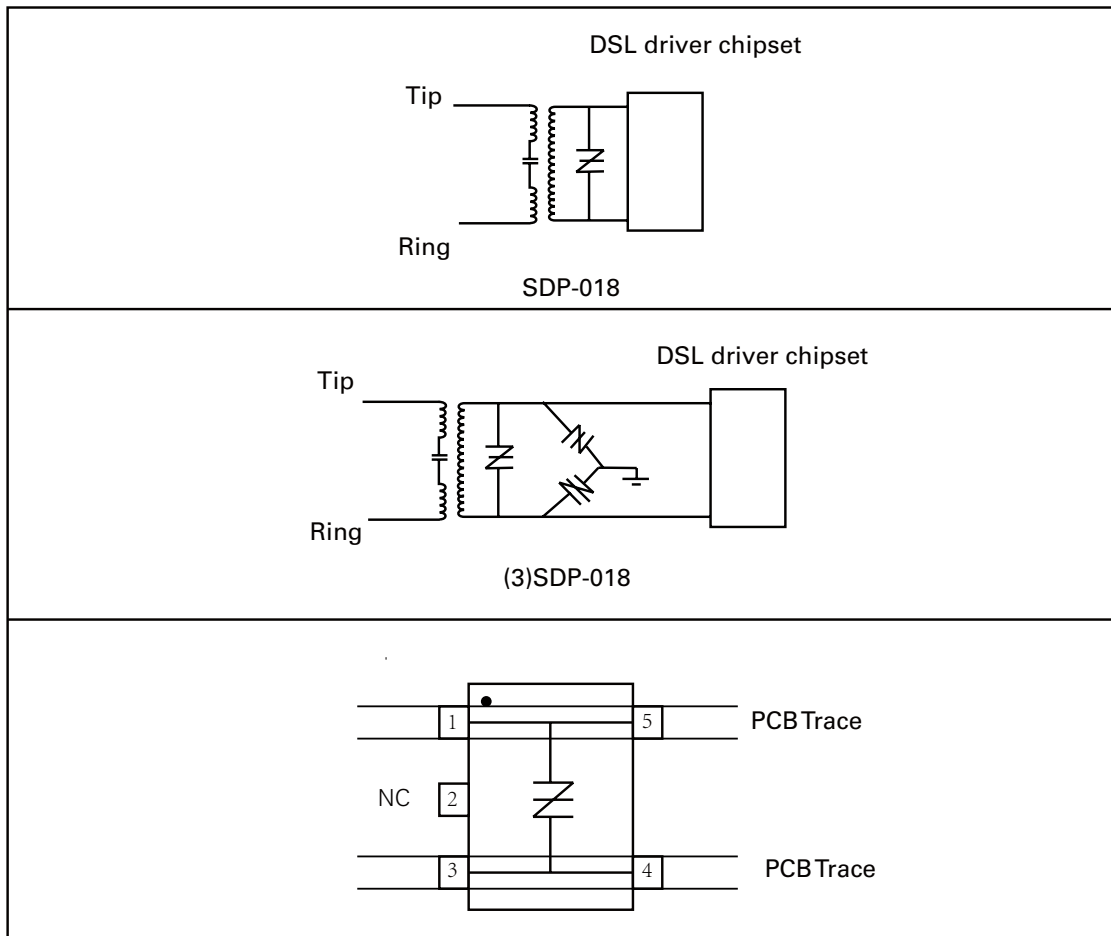

Part Numbering

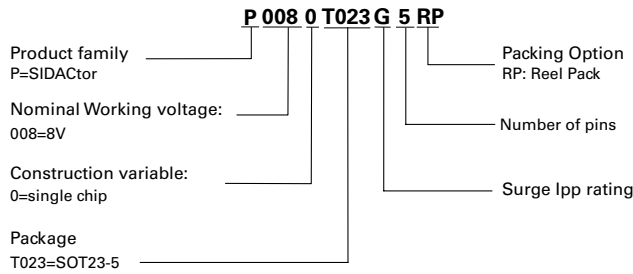

Part Marking

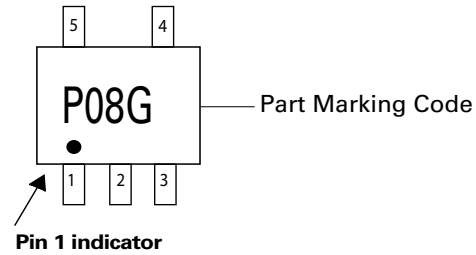

Soldering Parameters

Reflow Condition	Pb-Free assembly (see Fig. 1)	
Pre Heat	-Temperature Min ($T_{s(min)}$)	+150°C
	-Temperature Max ($T_{s(max)}$)	+200°C
	-Time (Min to Max) (t_s)	60-180 secs.
Average ramp up rate (Liquidus Temp (T_L) to peak)	3°C/sec. Max.	
$T_{s(max)}$ to T_L - Ramp-up Rate	3°C/sec. Max.	
Reflow	-Temperature (T_L) (Liquidus)	+217°C
	-Temperature (t_l)	60-150 secs.
Peak Temp (T_p)	+260(+0/-5)°C	
Time within 5°C of actual PeakTemp (t_p)	30 secs. Max.	
Ramp-down Rate	6°C/sec. Max.	
Time 25°C to Peak Temp (T_p)	8 min. Max.	
Do not exceed	+260°C	

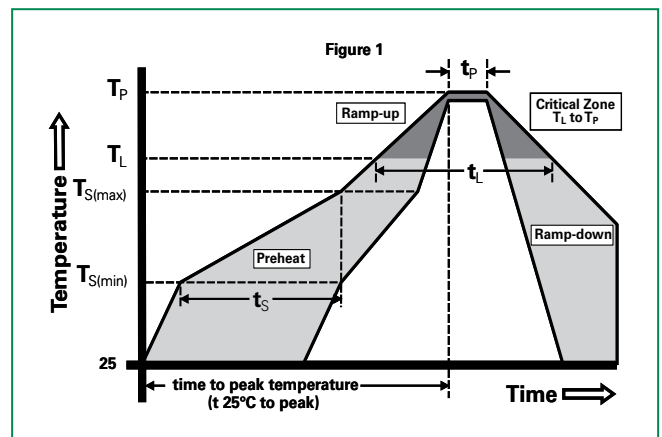

Physical Specifications

Terminal Material	100% Matte-Tin Plated
Solderability	EIA J-STD-002, TEST A.

Environmental Specifications

Temp Cycling	Mil-STD-883F, Method 1010.8 Condition C, -65°C to +150°C 168 Hrs, 85°C /60% RH+3IR-Reflow, 260°C +5V, -0°C
Bias Humidity	JESD 22-A101-B 85°C , 85%CRH. 50V 168 Hrs, 85°C /60% RH+3IR-Reflow, 260°C +5V, -0°C
Pressure Cooker	JEDEC 22-A102C No Bias, 121°C, 100%RH 96Hrs/192Hrs. 168 Hrs, 85°C /60% RH+3IR-Reflow, 260°C +5V, -0°C
High Temp Storage	JESD 22-A103C Con B. 150°C, no bias 1000Hrs
HTRB	JESD 22-108C 168 Hrs, 85°C /60% RH+3IR-Reflow, 260°C +5V, -0°C
Thermal Shock	Mil-STD-883F, Method 1011.9 Condition A, 0°C to 100°C 168 Hrs, 85°C /60% RH+3IR-Reflow, 260°C +5V, -0°C
C-SAM	As per flow, JSTD-020C pre&post preconditioning test.
Wet Humidity (Tin only)	NEMI standard: 60°C/93% RH

Packing Options

Package Type	Description	Quantity	Added Suffix	Min. Order Qty.	Industry Standard
T023	SOT23-5 Tape & Reel Pack	3000	RP	3000	EIA-481-A

Tape and Reel Specification — SOT23-5

8mm TAPE AND REEL

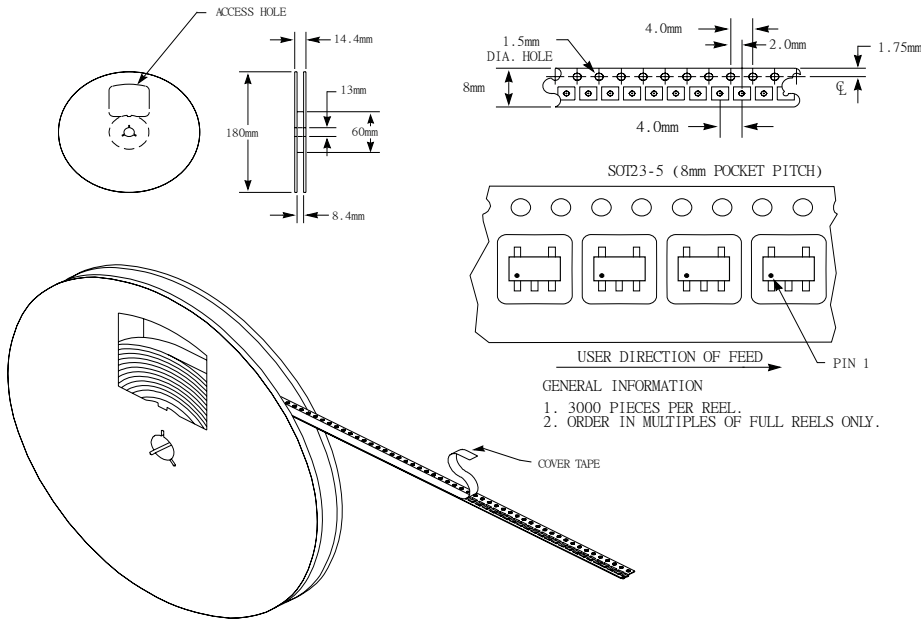

Disclaimer Notice - Information furnished is believed to be accurate and reliable. However, users should independently evaluate the suitability of and test each product selected for their own applications. Littelfuse products are not designed for, and may not be used in, all applications. Read complete Disclaimer Notice at www.littelfuse.com/disclaimer-electronics.