

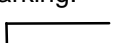
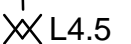

Specification Status: Released

Electrical Rating
Voltage: 16VDC MAX
Current: 50A MAX

Insulating Material:
Cured, Flame Retardant Epoxy Polymer
Meets UL94 V-0 Requirements

Lead Material:
20 AWG Tin Plated Copper
(0.81 mm [0.032in.] nom. diameter)

Marking:
 Manufacturer's Mark
 XX L4.5 and Part Identification
 Lot Identification

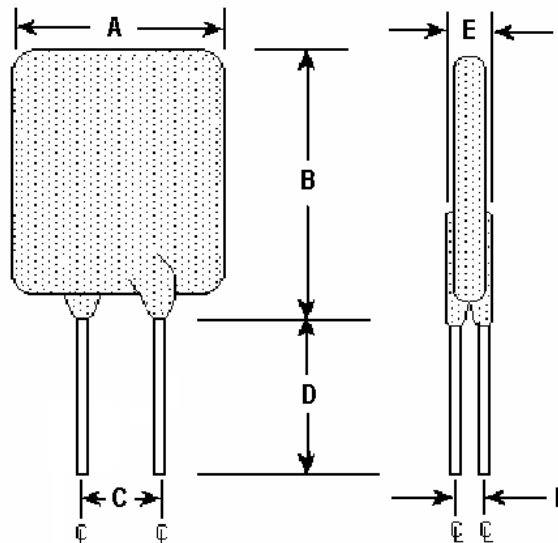

TABLE I. DIMENSIONS:

	A		B		C		D		E		F
	MIN	MAX	MIN	MAX	MIN	MAX	MIN	MAX	MIN	MAX	TYP
mm:	--	8.4	--	14.1	4.3	5.8	7.6	--	--	3.0	1.2
in*:	--	(0.33)	--	(0.56)	(0.17)	(0.23)	(0.30)	--	--	(0.12)	(0.05)

*Rounded off approximation

TABLE II. PERFORMANCE RATINGS:

CURRENT RATINGS		TIME TO TRIP	INITIAL RESISTANCE VALUES		R ₁ MAX	TRIPPED-STATE POWER DISSIPATION
AMPS AT 25°C HOLD	AMPS AT 25°C TRIP	SECONDS AT 25°C, 22.5A MAX	OHMS AT 25°C MIN	OHMS AT 25°C MAX	OHMS AT 25°C	WATTS AT 25°C 16V TYP
4.5	9.0	5.5	0.0145	0.0260	0.0400	3.5

Agency Recognitions:
Reference Documents:
Precedence:
Effectivity:
CAUTION:

UL
PS300, PS400 (reference for R₁ MAX)
This specification takes precedence over documents referenced herein.
Reference documents shall be the issue in effect on the date of invitation for bid.
Operation beyond the rated voltage or current may result in rupture, electrical arcing or flame.

Materials Information
ROHS Compliant

ELV Compliant

Pb-Free

Halogen Free⁺

Directive 2011/65/EU Compliant

Directive 2000/53/EC Compliant



* Halogen Free refers to: Br≤900ppm, Cl≤900ppm, Br+Cl≤1500ppm

TABLE III. AUTOMOTIVE SPECIFIC STRESS TESTS AND TEST CONDITIONS:

ELECTRICAL STRESS TESTS	TEST CONDITIONS (see note 2)
ESD Voltage Withstand (see note 1)	25kV
Short Circuit Fault Current Durability	25 cycles, 16V, 200A
Fault Current Durability	350 cycles, 16V/50A
End-of-life Mode Verification	1750 cycles, 16V/50A
Jump Start Endurance (see note 1)	3 cycles, 26V, 1 minute duration
Load Dump Endurance (see note 1)	10 cycles, 86.5V

Note 1: The PolySwitch devices are tested in series with a load resistance and the voltages specified in the test conditions are shared between the PolySwitch device and the load resistance as specified in PS400.

Note 2: Please refer to Appendix A of PS400 for the detailed test procedures

Information furnished is believed to be accurate and reliable. However, users should independently evaluate the suitability of and test each product selected for their own applications. Littelfuse products are not designed for, and shall not be used for, any purpose (including, without limitation, military, aerospace, medical, lifesaving, life-sustaining or nuclear facility applications, devices intended for surgical implant into the body, or any other application in which the failure or lack of desired operation of the product may result in personal injury, death, or property damage) other than those expressly set forth in applicable Littelfuse product documentation. Warranties granted by Littelfuse shall be deemed void for products used for any purpose not expressly set forth in applicable Littelfuse documentation. Littelfuse shall not be liable for any claims or damages arising out of products used in applications not expressly intended by Littelfuse as set forth in applicable Littelfuse documentation. The sale and use of Littelfuse products is subject to Littelfuse Terms and Conditions of Sale, unless otherwise agreed by Littelfuse.