

LS0503EVD22L

5 V, 3 A eFuse with Overvoltage and Overcurrent Protection

HF RoHS Pb



Web Resources



Download ECAD models, order samples, and find technical resources at www.littelfuse.com

Pinout Designation

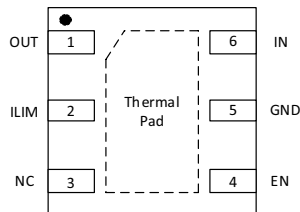

Top View

Pin Description

No	Name	I/O	Description
EN	4	I	Logic-level control input. When this pin is driven high, the power switch is enabled. When this pin is driven low, the power switch turns off. This pin cannot be left floating and it must be limited below the absolute maximum rating if tied to the IN pin.
NC	3	-	-
GND	5	—	Ground connection. Connect this pin externally to the exposed thermal pad.
ILIM	2	O	External resistor. The ILIM pin is used to set the current-limit threshold. The recommended value for this pin is: $36 \text{ k}\Omega \leq \text{RILIM} \leq 1100 \text{ k}\Omega$.
IN	6	I	Input voltage. Connect a ceramic capacitor with a value of $0.1 \mu\text{F}$ or greater from the IN pin to the GND pin as close to the IC as possible.
OUT	1	O	Protected power switch, VOUT. Connect a ceramic capacitor with a value of $0.1 \mu\text{F}$ or greater between OUT pin and GND.
Thermal pad	—	—	The exposed thermal pad is internally connected to the GND pin. Use the thermal pad to heat-sink the device to the circuit board pads. Connect the thermal pad to the GND pin externally.

Description

The LS0503EVD22L integrated load switch provides a robust input over-current protection to downstream circuit systems. The device comes with built-in over-voltage protection, internal soft-start. The switch's low RDS(ON) minimizes power loss of the system. In the event of input over voltage, LS0503EVD22L immediately turns off the switch to prevent downstream system from stress of excessive high voltage. Set the current limit level with an external resistor. Internal soft-start ensures a smooth output voltage ramp-up and limits the input in-rush current.

Features & Benefits

- Wide Input Voltage Range from 2.7 V to 5.7 V
- 30 V Maximum Input Voltage
- Built-in Fast Response Over-Voltage Protection at 5.7 V
- 100 m Ω Low $R_{\text{DS(ON)}}$ Protection Switch
- Discharge Output at OVP
- Internal Soft-Start
- Thermal Shutdown
- Programmable Current Limit Peak Current Up to 3 A
- Hiccup Mode Protection for Over Load or Short Circuit
- DFN2X2_6L Package
- Pb-Free and RoHS Compliant

Applications

- Bluetooth Headsets
- Wearable Device
- Tablet PC
- Charging Cable
- Battery Devices
- Adapter Powered Devices

Typical Applications

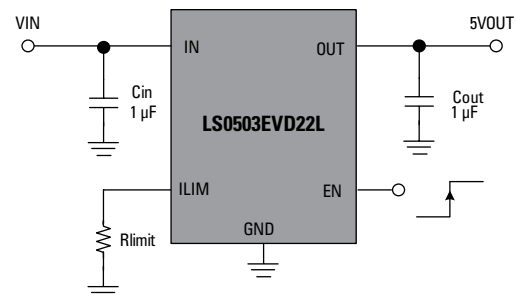

Functional Block Diagram

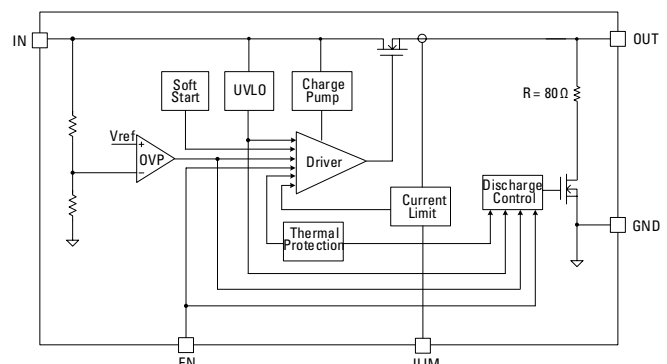

LS0503EVD22L

5 V, 3 A eFuse with Overvoltage and Overcurrent Protection

Absolute Maximum Rating (Reference to GND)

Symbol	Value	Units
IN, OUT	-0.3 to +30	V
ILIM	-0.3 to +6.5	V
ESD	Class 2	
Junction Temperature Range	-40 to +150	°C
Storage Temperature Range	-65 to +150	°C
Lead Temperature (Soldering 10s)	260	°C

* Notes: Stress exceeding those listed "Absolute Maximum Ratings" may damage the device.

Thermal information

Symbol	Value	Units
Maximum Power Dissipation ($T_A = 25\text{ °C}$)	1.52	W
Thermal Resistance (θ_{JA})	82	°C/W
Thermal Resistance (θ_{JC})	52	°C/W

Notes:

1: Measured on JESD51-7, 4-Layer PCB.

2: The maximum allowable power dissipation is a function of the maximum junction temperature $T_{j,MAX}$, the junction to ambient thermal resistance θ_{JA} , and the ambient temperature T_A . The maximum allowable continuous power dissipation at any ambient temperature is calculated by $P_{D,MAX} = (T_{j,MAX} - T_A) / \theta_{JA}$. Exceeding the maximum allowable power dissipation will cause excessive die temperature, and the regulator will go into thermal shutdown. Internal thermal shutdown circuitry protects the device from permanent damage.

Recommend Operating Conditions

Symbol	Value	Units
Input Voltage (IN)	+2.7 to +5.7	V
Operating Temperature Range	-40 to +85	°C
Junction Temperature Range	+125	°C

* Notes: The device is not guaranteed to function outside of the recommended operating conditions.

Electrical Characteristics ($T_A = +25\text{ °C}$, $V_{IN} = 5\text{ V}$, $C_{IN} = 1\text{ }\mu\text{F}$, unless otherwise specified)

Symbol	Parameter	Test Conditions	Min	Nom	Max	Unit
V_{IN}	Input Voltage Range	-	2.7	-	5.7	V
I_{BIAS}	Quiescent Current	-	-	200	260	μA
I_{SD}	Shutdown Current	$V_{EN} = 0\text{ V}$	-	5	10	μA
$R_{DS(ON)}$	Power Switch On Resistance	-	-	100	-	m Ω
V_{UV}	Input Under-voltage Threshold	-	-	2.48	-	V
V_{UVHYS}	Input Under-voltage Hysteresis	-	-	180	-	mV
V_{OV}	Input Over-voltage Threshold	-	-	5.7	-	V
V_{OV}	Over Voltage Protection response time	-	-	250	-	ns
V_{OV}	Input Over-voltage Hysteresis	-	-	330	-	mV
T_{SS}	Soft-start Time	-	-	230	-	μs
I_{LIMT}	Current Limit	$R_{LIM} = 500\text{ k}\Omega$	1.35	1.5	1.65	A
K_{LIM}	Current Limit Setting Factor	$I_{INLIM} = 1\text{ A} \sim 3\text{ A}$	-	650	-	A*k Ω
R_{Disch}	OUT Discharging Resistance	$V_{IN} = 6.5\text{ V}$	-	80	-	Ω
$V_{IH,EN}$	EN Logic High Input Voltage	-	1.2	-	-	V
$V_{IL,EN}$	EN Logic Low Input Voltage	-	-	-	0.4	V
T_{SD}	Thermal Shutdown Temperature	-	-	160	-	°C
T_{HYS}	Thermal Shutdown Hysteresis	-	-	40	-	°C

LS0503EVD22L

5 V, 3 A eFuse with Overvoltage and Overcurrent Protection

Figure 1 - Quiescent Current vs. Input Voltage

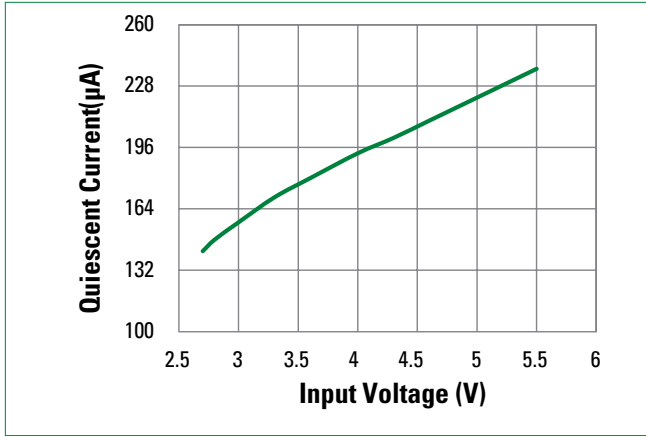

Figure 2 - RLimit vs. ILimit (5V_{IN} Application)

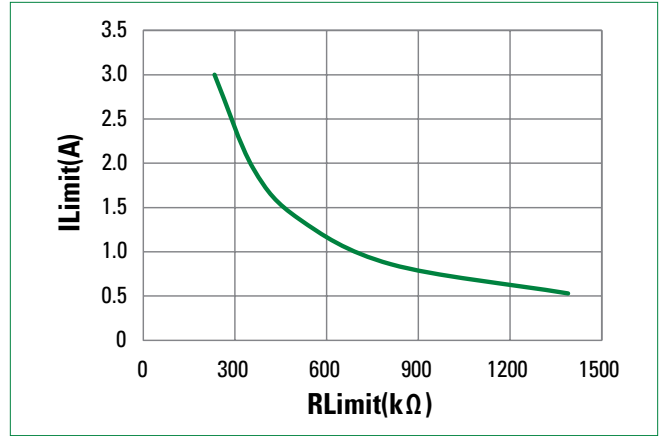

Figure 3 - V_{IN} On (5V_{IN}, I_O = 0 A)

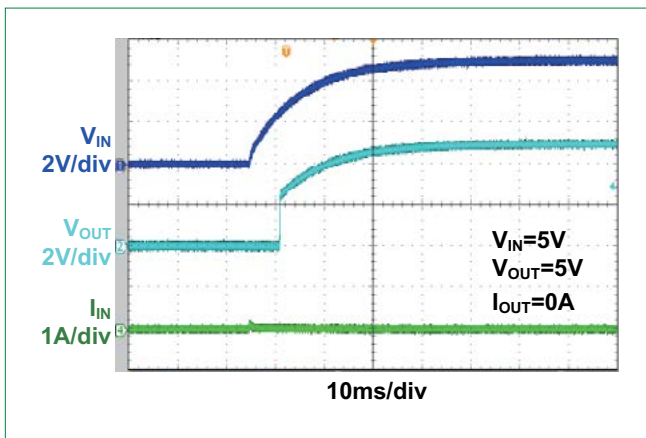

Figure 4 - V_{IN} Off (5V_{IN}, I_O = 0 A)

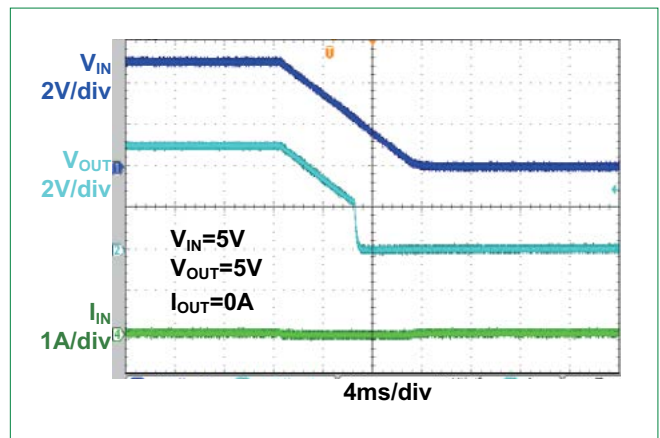

Figure 5 - V_{IN} On (5V_{IN}, I_O = 3 A)

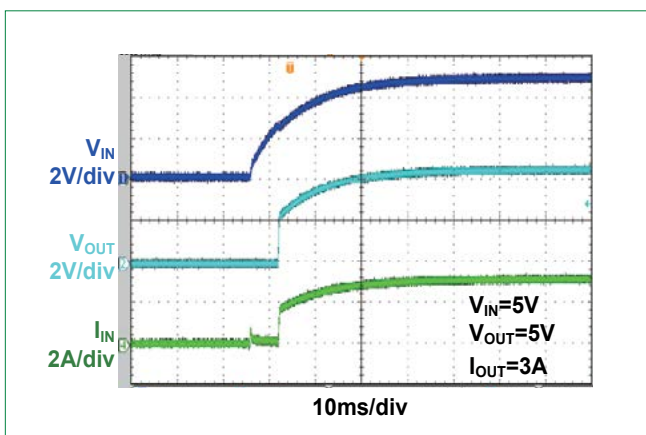
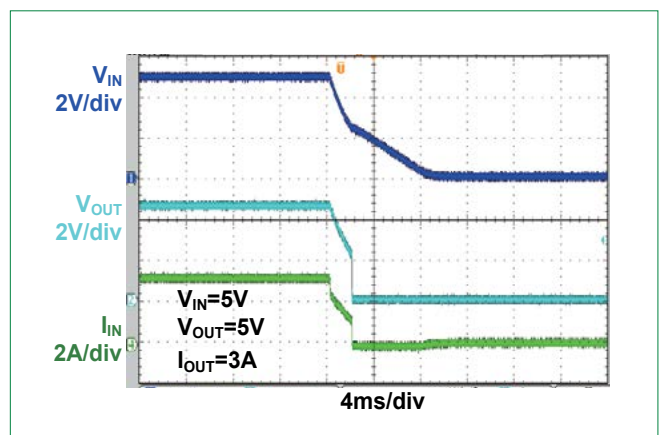

Figure 6 - V_{IN} Off (5V_{IN}, I_O = 3 A)



LS0503EVD22L

5 V, 3 A eFuse with Overvoltage and Overcurrent Protection

Figure 7 - Soft Start ($3.3V_{IN}, I_o = 0 A$)

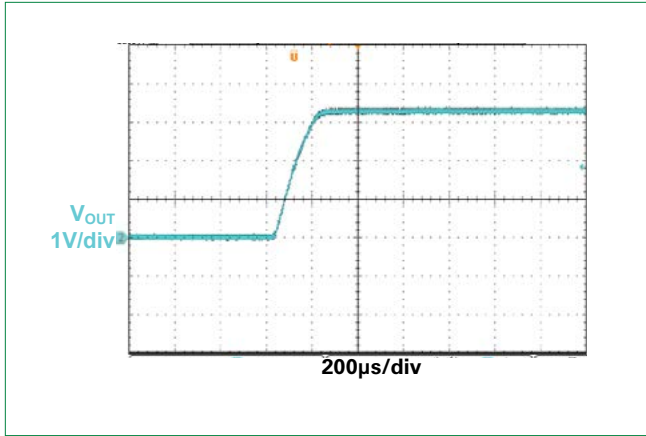

Figure 8 - Soft Start ($5V_{IN}, I_o = 0 A$)

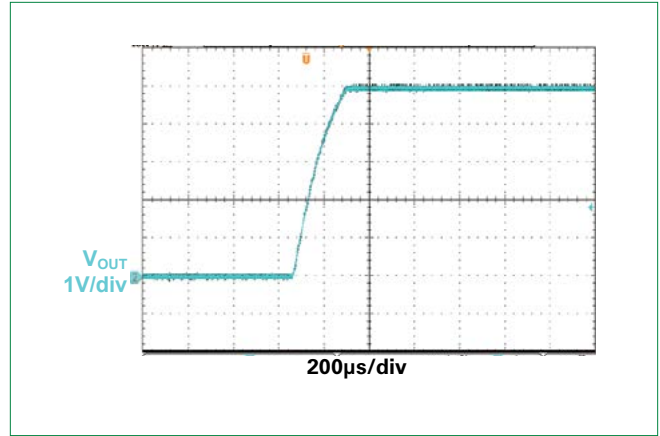

Figure 9 - Current Limit ($5V_{IN}, R_{limit} = 220 k$)

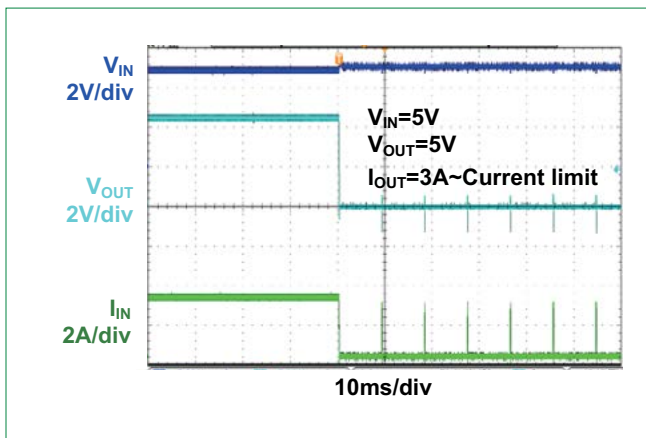

Figure 10 - Current Limit ($5V_{IN}, R_{limit} = 500 k$)

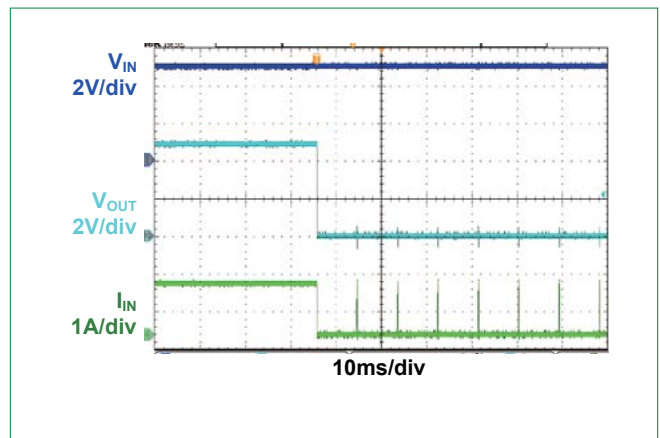

Figure 11 - Short Protection ($5V_{IN}, R_{limit} = 220 k$)

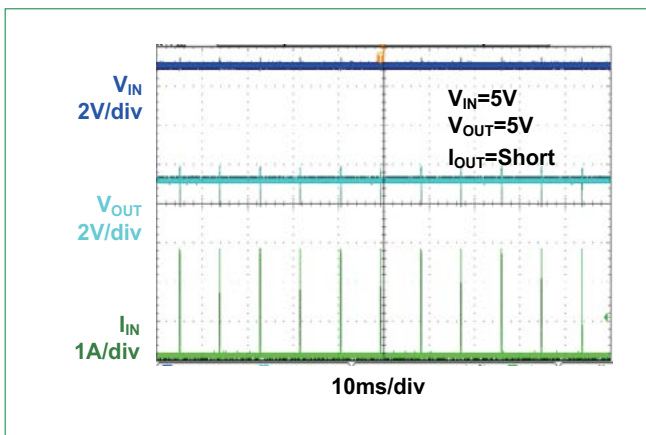
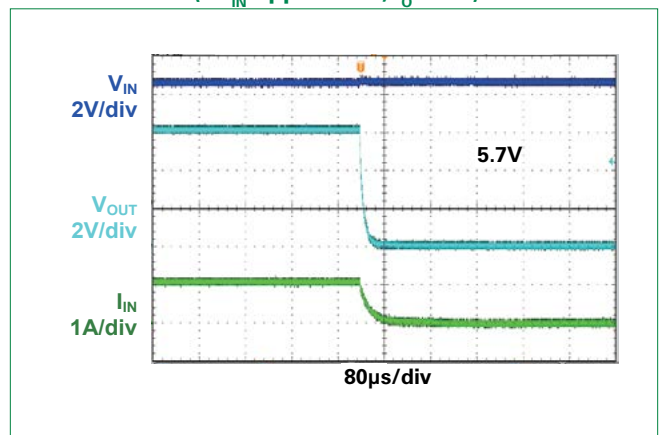

Figure 12 - Over Voltage Protection ($5V_{IN}$ Application, $I_o = 1 A$)



LS0503EVD22L

5 V, 3 A eFuse with Overvoltage and Overcurrent Protection

Detailed Description

The LS0503EVD22L is a fully integrated load switch with built-in over-voltage protection, internal soft-start and programmable current limit. When the input voltage is within the valid range (2.7 V~5.7 V), the output pin OUT will ramp up with a fixed slew rate defined by internal soft-start. After OUT ramps up to input level, the internal load switch is fully turned on and ready to supply power to the system.

LS0503EVD22L continuously monitors the system load current through the switch when the power is on. Once the load current reaches the current limit ILIMIT programmed by ILIMIT pin, LS0503EVD22L will regulate the load current for 60 μs to prevent the load current from running away. After 60 μs, if the current limit condition sustains, LS0503EVD22L will turn off the load switch, wait for 8 ms and then try to re-start. In the event of system short circuit failure, the load current could jump significantly higher than the current limit. Whenever the load current is 2 A larger than the current limit level, LS0503EVD22L immediately turns off the load switch to prevent device damage and waits for 8ms before it tries to re-start.

LS0503EVD22L has an internal input OVP to protect the system from being stressed by excessively high voltage. Once it detects input voltage is higher than the built-in over-voltage threshold, LS0503EVD22L immediately turns off the load switch. The load switch turns on automatically once the input voltage falls within the valid range.

The LS0503EVD22L also has thermal shutdown protection, when device temperature (T_J) exceeds T_{SHDN} , typically 160 °C, the thermal shutdown circuitry will shut down the internal MOSFET thereby disconnecting the load from the input supply. The LS0503EVD22L will remain off until the device temperature falls below $T_{SHDN} - 40$ °C, after which it will attempt to restart.

Programmable Over-Current Protection

A programmable current limit level and short circuit current protection has been designed to prevent the load current overload the regulator. When the input current limit loop is engaged, input current will be automatically reduced to the pre-determined level which is set by ILIM pin, and regulate the load current for 60us, then enter hiccup mode waiting for 10ms to reduce power dissipation. When a short event happens, the short protection circuit will be triggered and turn off power switch quickly, LS0503EVD22L will restart after 10ms. The output can be shorted to ground indefinitely without damaging the part.

Input current limit can be programmed with below equation:

$$I_{INLIM} = \frac{650A * k\Omega}{R_{ILIM}}$$

Where R_{LIM} is the program resistor at the I_{LIM} pin.

Program Current Limit Resistance (kΩ)	650	325	216.5
Current Limit I_{INLIM} (A)	1	2	3

For the stable system operation, recommend to set the current limit level 1.2~1.5 times of the maximum system load current to avoid mis-triggering the current limit and causing system malfunctions.

Soft Start

When LS0503EVD22L is power on, VOUT will ramp up with a controlled rising time for minimizing inrush current.

Enable

Enable interface pin. Pull it above ON threshold High to enable the IC. Pull it below OFF threshold to disable the IC.

Input and Output Capacitor Selection

The LS0503EVD22L require ≥ 1 μF input and output capacitor connected to GND. Although X7R type capacitors are recommended, X5R and others may be used.

PCB Layout Guideline

- For all applications, a 0.1 μF or greater ceramic decoupling capacitor is recommended between IN terminal and GND, and a 0.1 μF or greater ceramic decoupling capacitor is recommended between OUT terminal and GND. For hot-plug applications, where input power path inductance is negligible, this capacitor can be eliminated/minimized.
- The optimum placement of decoupling capacitor is closest to the IN and GND terminals of the device. Care must be taken to minimize the loop area formed by the bypass-capacitor connection, the IN terminal, and the GND terminal of the IC.
- High current carrying power path connections should be as short as possible and should be sized to carry at least twice the full-load current.
- The GND terminal must be tied to the PCB ground plane at the terminal of the IC. The PCB ground should be a copper plane or island on the board.
- Obtaining acceptable performance with alternate layout schemes is possible; however, this layout has been shown to produce good results and is intended as a guideline.

LS0503EVD22L

5 V, 3 A eFuse with Overvoltage and Overcurrent Protection

Application Schematic

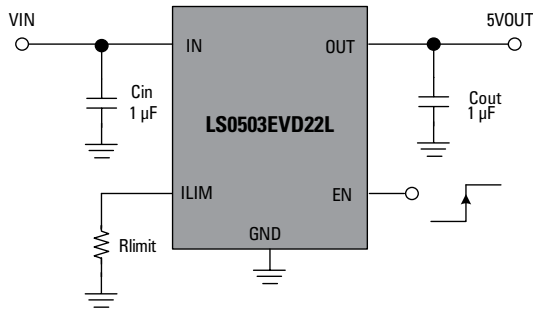

Bill of Materials

Qty	Ref	Value	Description	Package
2	CIN2, CO2	1 µF	Ceramic Capacitor, 35 V, X5R	0805
1	Rlimit	500 kΩ	Resistor, ±1 %	0603
1	R1	NC	Resistor, ±1 %	0603
1	U1	LS0503EVD22L	eFuse IC	DFN2x2_6L

Soldering Parameters

Average Ramp Up Rate (T_{smin} to T_p)	1~2 °C/second, 3 °C/second max	
Preheat & Soak	- Temperature Min (T _{s(min)})	150 °C
	- Temperature Max (T _{s(max)})	200 °C
	- Time (min to max) (t _s)	60 – 120 seconds
Time Maintained Above	- Temperature(T _L)	217 °C
	- Time(t _L)	60~150 seconds
Peak Temperature (T_p)	See classification temp in table below	
Time Within 5°C of Actual Peak Temperature (t_p)	30 seconds max	
Ramp-down Rate	6 °C/second max	
Time 25 °C to Peak Temperature (T_p)	8 minutes max	

Notes:

1. Tolerance for peak profile Temperature(T_p) is defined as a supplier minimum and a user maximum.
2. Tolerance for time at peak profile temperature (t_p) is defined as a supplier minimum and a user maximum.

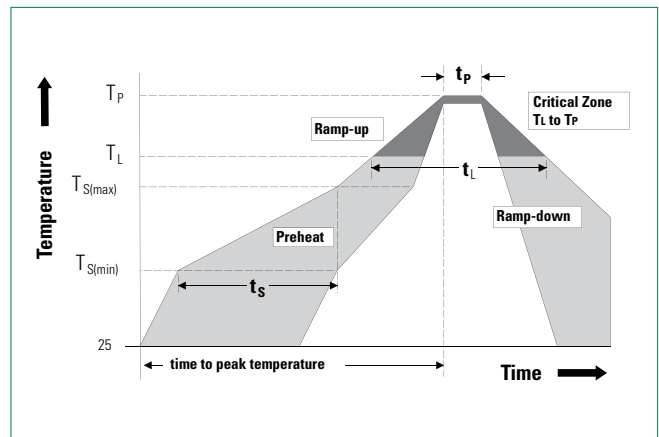

Pb-free Process –Classification Temperatures (TC)

Package Thickness	Volume mm ³ <350	Volume mm ³ 350-2000	Volume mm ³ >2000
	<1.6 mm	260 °C	260 °C
1.6 mm–2.5 mm	260 °C	250 °C	245 °C
>2.5 mm	250 °C	245 °C	245 °C
-	3,4,5,6	NC	No Connection

Note: For all temperature information, please refer to top side of the package, measured on the package body surface.

Ordering Information

Part Number	Package	Min Order Qty
LS0503EVD22L	DFN2x2_6L	3000/Tape & Reel

LS0503EVD22L

5 V, 3 A eFuse with Overvoltage and Overcurrent Protection

Part Numbering

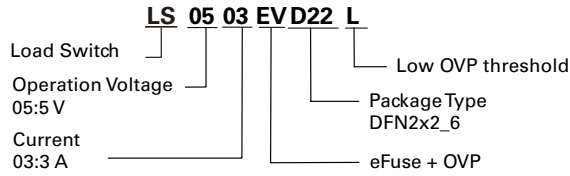

Part Marking

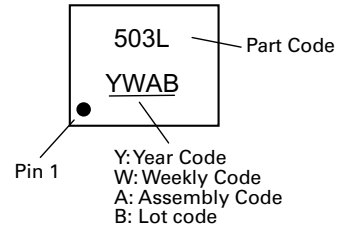

Dimensions — DFN2x2_6L

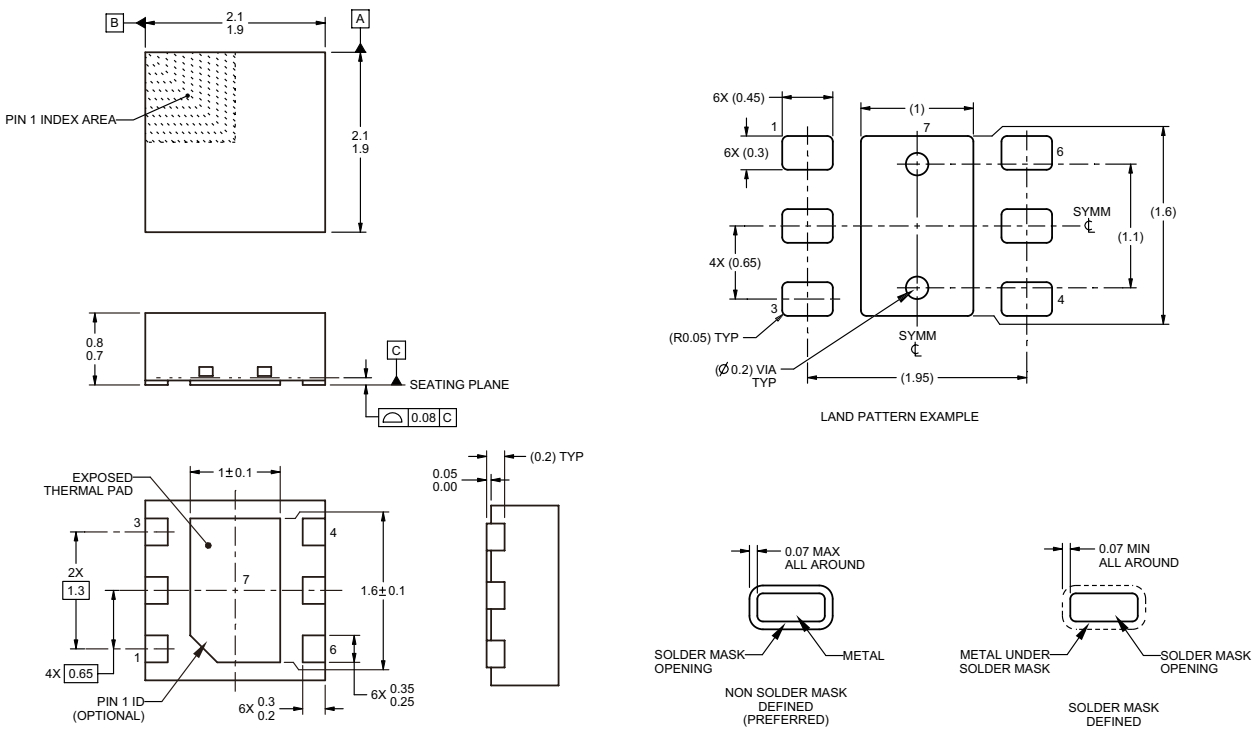

Carrier Tape & Reel Specification — DFN2x2_6L

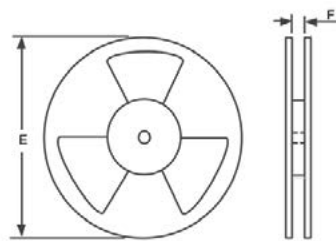
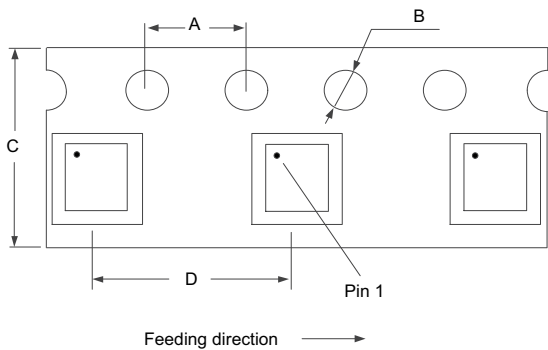

Symbol	Millimeters
A	4.0
B	1.5
C	8.0
D	4.0
E	7 inch
F	9.0

Disclaimer Notice - Information furnished is believed to be accurate and reliable. However, users should independently evaluate the suitability of and test each product selected for their own applications. Littelfuse products are not designed for, and may not be used in, all applications. Read complete Disclaimer Notice at <http://www.littelfuse.com/disclaimer-electronics>.