

LQ05021QCS4

5 V, 2 A Ultra Low Consumption Load Switch With Slew Rate Control

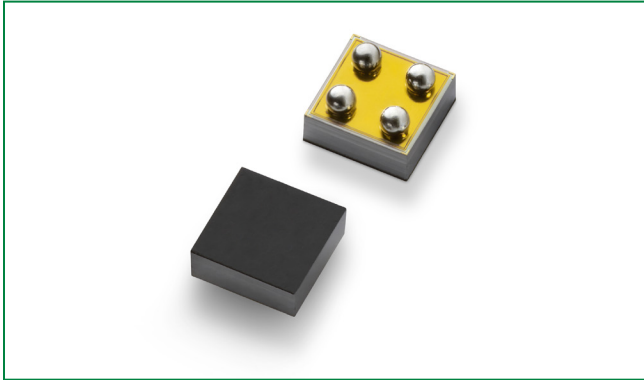

Description

The LQ05021QCS4 is an ultimted efficient, 2 A rated integrated load switch with slew rate control. Its outstanding performance in efficiency makes this an ideal solution for applications like IoT, mobile and wearable.

This remarkable device incorporates cutting-edge technology that achieves industry-leading performance in terms of the lowest quiescent current (I_Q), and shutdown current (I_{SD}). The low I_Q and I_{SD} solutions empower designers to curtail parasitic leakage current, enhance system efficiency, and extend battery lifespan.

The integration of slew rate control within the LQ05021QCS4 serves as a critical enhancement to system reliability, effectively mitigating voltage swings on the bus during switching events. In situations where uncontrolled switches might otherwise generate substantial inrush currents, leading to voltage droop and potential bus reset events, the slew rate control functions to confine inrush current during activation, thereby minimizing the voltage droop.

The LQ05021QCS4 load switch device is designed in a chip scale package of 0.77 mm x 0.77 mm x 0.46 mm with 4 bumps and 0.4 mm pitch and support an extensive input voltage range, enhancing both the operational lifespan and the resilience of the system. Additionally, this single device can serve in various voltage rail applications, streamlining inventory management and lowering operational expenses.

Pinout Designation

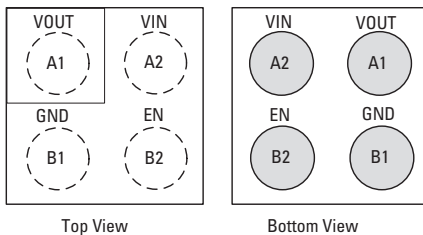

Pin Description

Pin #	Pin Name	Description
A1	V_{OUT}	Switch output
A2	V_{IN}	Switch input. Supply voltage for IC
B1	GND	Ground
B2	EN	Enable to control the switch. The EN pin has an internal pull-down resistor

Features and Benefits

- Ultra-low I_Q : 1 nA Typ @ 5.5 V_{IN}
- Ultra-low I_{SD} : 19 nA Typ @ 5.5 V_{IN}
- Low R_{ON} = 34 m Ω Typ @ 5.5 V_{IN}
- I_{OUT} max = 2.0 A
- Wide input range: 1.1 V to 5.5 V, 6 Vabs max
- Controlled rise time: 430 μ s at 3.3 V_{IN}
- Internal EN pull-down resistor
- Integrated output discharge switch
- Ultra small: 4 bumps in a 0.77 mm x 0.77 mm x 0.46 mm WLCSP

Applications

- Mobile devices
- Data storage, SSD
- IoT devices
- Wearables
- Low power subsystems

LQ05021QCS4

5 V, 2 A Ultra Low Consumption Load Switch With Slew Rate Control

Functional Block Diagram

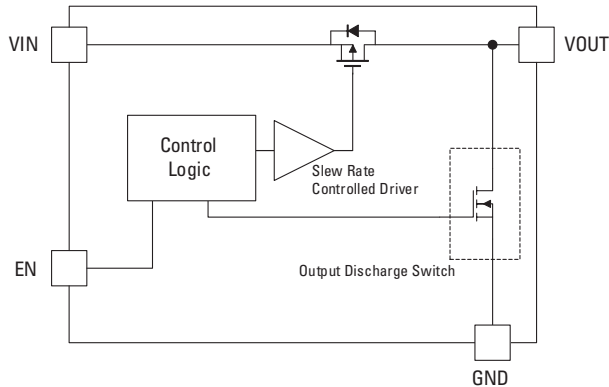

Typical Applications

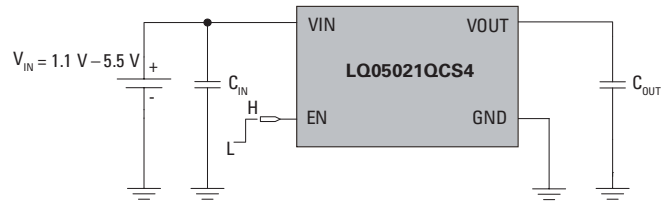

Absolute Maximum Rating

Symbol	Parameter	Min	Max	Unit
V_{IN}, V_{OUT}, V_{EN}	Each Pin Voltage Range to GND	-0.3	6	V
I_{OUT}	Maximum Continuous Switch Current		2	A
P_D	Power Dissipation at $T_A = 25\text{ }^\circ\text{C}$		1	W
T_{STG}	Storage Junction Temperature	-65	150	$^\circ\text{C}$
T_J	Maximum Junction Temperature		150	$^\circ\text{C}$
θ_{JA}	Thermal Resistance, Junction to Ambient (board dependent)		110	$^\circ\text{C}/\text{W}$
ESD	Electrostatic Discharge Capability	Human Body Model, JESD22-A114	6	kV
		Charged Device Model, JESD22-C101	2	kV

Note: Stresses exceeding the absolute maximum ratings may damage the device. The device may not function or be operable above the recommended operating conditions; extended exposure to stresses above the recommended operating conditions may affect device reliability. The absolute maximum ratings are stress ratings only.

Recommend Operating Conditions

Symbol	Parameter	Min	Max	Unit
V_{IN}	Supply Voltage	1.1	5.5	V
T_A	Ambient Operating Temperature	-40	85	$^\circ\text{C}$

Note: The device is not guaranteed to function outside of the recommended operating conditions.

LQ05021QCS4

5 V, 2 A Ultra Low Consumption Load Switch With Slew Rate Control

Electrical Characteristics (Values are at $V_{IN} = 3.3\text{ V}$ and $T_A = 25\text{ °C}$ unless otherwise noted.)

Symbol	Parameter	Test Conditions	Min	Typ	Max	Unit
Basic Operation						
V_{IN}	Supply Voltage		1.1		5.5	V
I_Q	Quiescent Current	$V_{IN} = V_{EN} = 5.5\text{ V}, I_{OUT} = 0\text{ mA}$		520		nA
		$V_{IN} = V_{EN} = 5.5\text{ V}, I_{OUT} = 0\text{ mA}^1$		1		nA
		$V_{IN} = V_{EN} = 5.5\text{ V}, I_{OUT} = 0\text{ mA}, T_A = 85\text{ °C}^1$		12		nA
I_{SD}	Shutdown Current	EN = Disable, $I_{OUT} = 0\text{ mA}, V_{IN} = 1.1\text{ V}$		3		nA
		EN = Disable, $I_{OUT} = 0\text{ mA}, V_{IN} = 1.8\text{ V}$		4		nA
		EN = Disable, $I_{OUT} = 0\text{ mA}, V_{IN} = 3.3\text{ V}$		6		nA
		EN = Disable, $I_{OUT} = 0\text{ mA}, V_{IN} = 4.5\text{ V}$		9		nA
		EN = Disable, $I_{OUT} = 0\text{ mA}, V_{IN} = 5.5\text{ V}$		19	50	nA
		EN = Disable, $I_{OUT} = 0\text{ mA}, V_{IN} = 5.5\text{ V}, T_A = 55\text{ °C}$		110		nA
		EN = Disable, $I_{OUT} = 0\text{ mA}, V_{IN} = 5.5\text{ V}, T_A = 85\text{ °C}$		600		nA
R_{ON}	On-Resistance	$V_{IN} = 5.5\text{ V}, I_{OUT} = 500\text{ mA}$	$T_A = 25\text{ °C}$	34	47	mΩ
			$T_A = 85\text{ °C}$	40		mΩ
		$V_{IN} = 3.3\text{ V}, I_{OUT} = 500\text{ mA}$	$T_A = 25\text{ °C}$	42	56	mΩ
			$T_A = 85\text{ °C}$	50		mΩ
		$V_{IN} = 1.8\text{ V}, I_{OUT} = 300\text{ mA}$	$T_A = 25\text{ °C}$	68		mΩ
		$V_{IN} = 1.2\text{ V}, I_{OUT} = 100\text{ mA}$	$T_A = 25\text{ °C}$	125		mΩ
$V_{IN} = 1.1\text{ V}, I_{OUT} = 100\text{ mA}$	$T_A = 25\text{ °C}$	155		mΩ		
R_{DSC}	Output Discharge Resistance	$E_N = \text{Low}, I_{FORCE} = 10\text{ mA}$	70	85	100	Ω
V_{IH}	EN Input Logic High Voltage	$V_{IN} = 1.1\text{ V} - 1.8\text{ V}$	0.9			V
		$V_{IN} = 1.8\text{ V} - 5.5\text{ V}$	1.2			V
V_{IL}	EN Input Logic Low Voltage	$V_{IN} = 1.1\text{ V} - 1.8\text{ V}$			0.3	V
		$V_{IN} = 1.8\text{ V} - 5.5\text{ V}$			0.4	V
R_{EN}	EN Internal resistance	Internal Pull-down Resistance	7	10.1	13	MΩ
I_{EN}	EN Current	$E_N = 5.5\text{ V}$			0.8	μA
Switching Characteristics ²						
t_{dON}	Turn-On Delay	$R_L = 150\text{ Ω}, C_{OUT} = 0.1\text{ μF}$		275		μs
t_R	V_{OUT} Rise Time			430		μs
t_{dON}	Turn-On Delay ⁴	$R_L = 500\text{ Ω}, C_{OUT} = 0.1\text{ μF}$		245		μs
t_R	V_{OUT} Rise Time ⁴			410		μs
t_{dOFF}	Turn-Off Delay ^{3,4}	$R_L = 10\text{ Ω}, C_{OUT} = 0.1\text{ μF}$		0.38		μs
t_F	V_{OUT} Fall Time ^{3,4}			1.32		μs
t_{dOFF}	Turn-Off Delay ⁴	$R_L = 500\text{ Ω}, C_{OUT} = 0.1\text{ μF}$		1.1		μs
t_F	V_{OUT} Fall Time ^{3,4}			18		μs

Notes:

- I_Q does not include enable pull down current through the pull-down resistor RPD.
- $t_{ON} = t_{dON} + t_R$, $t_{OFF} = t_{dOFF} + t_F$
- Output discharge path is enabled during off.
- By design; characterized, not production tested.

LQ05021QCS4

5 V, 2 A Ultra Low Consumption Load Switch With Slew Rate Control

Timing Waveforms

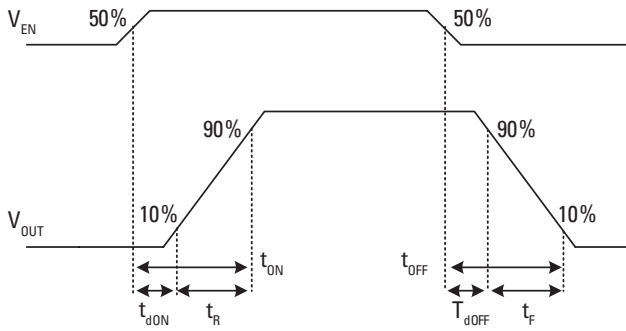

Typical Performance Characteristics

Figure 1 - On-Resistance vs. Supply Voltage

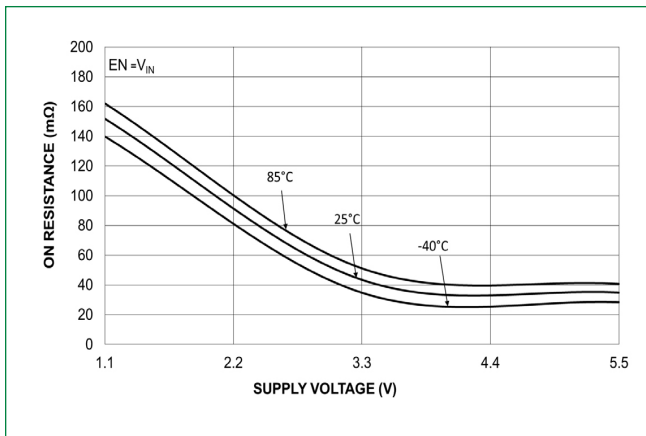

Figure 2 - On-Resistance vs. Temperature

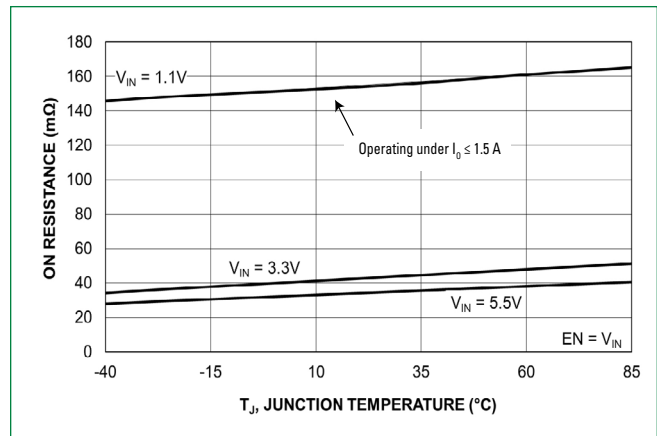

Figure 3 - Quiescent Current vs. Supply Voltage

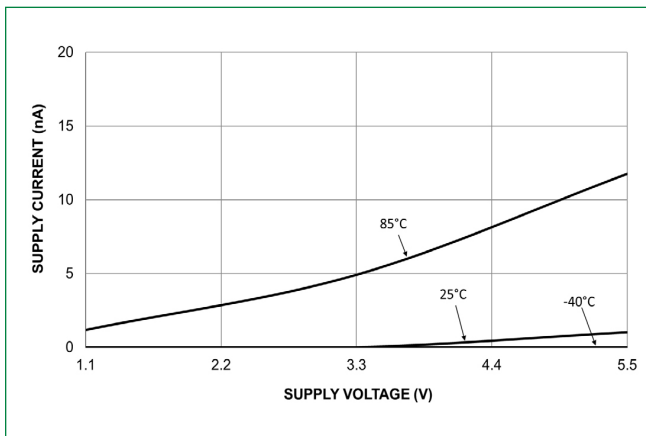
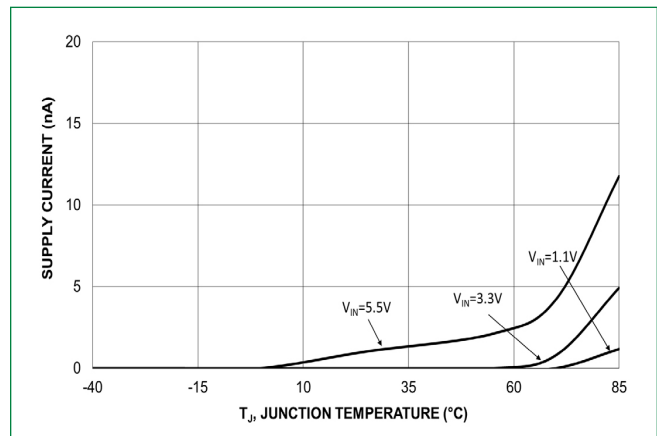

Figure 4 - Quiescent Current vs. Temperature



LQ05021QCS4

5 V, 2 A Ultra Low Consumption Load Switch With Slew Rate Control

Figure 5 - Shutdown Current vs. Supply Voltage

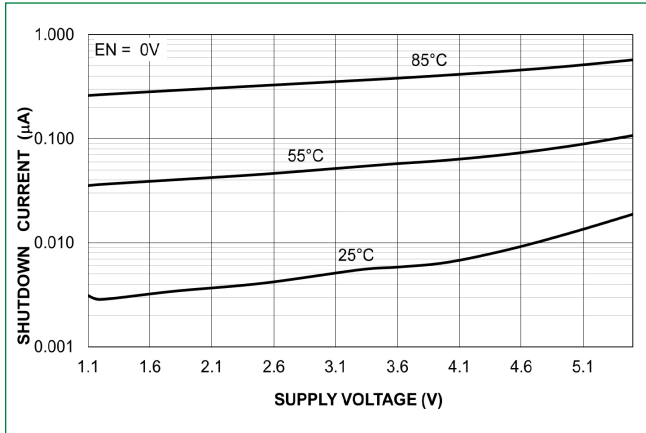

Figure 6 - Shutdown Current vs. Temperature

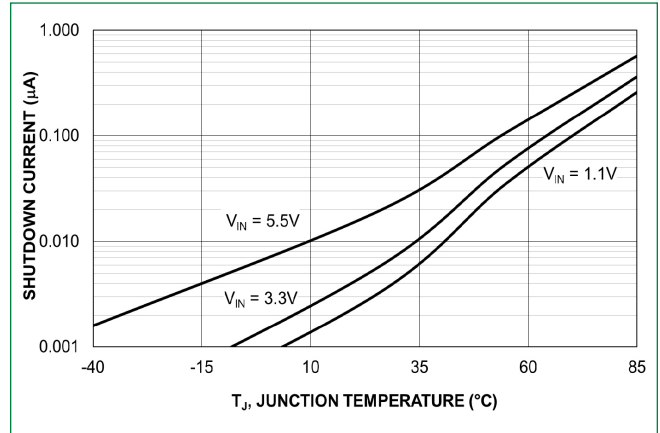

Figure 7 - EN Input Logic High Threshold

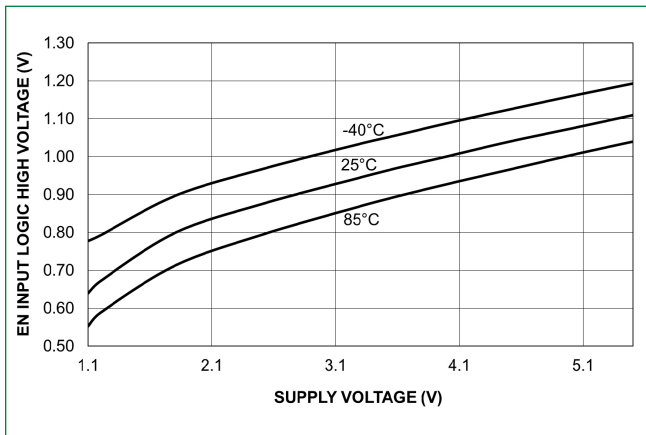

Figure 8 - EN Input Logic High Threshold Vs. Temperature

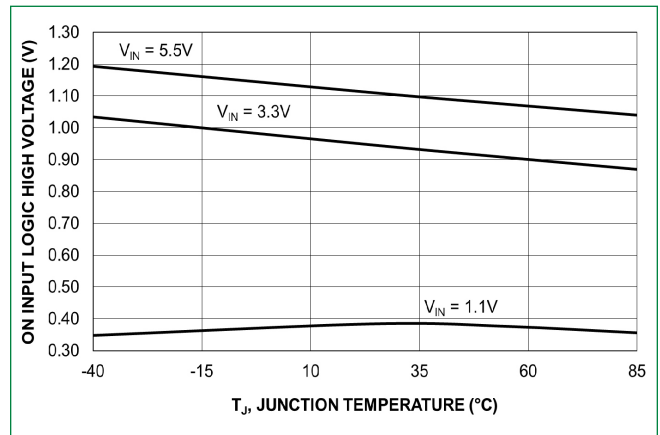

Figure 9 - EN Input Logic Low Threshold

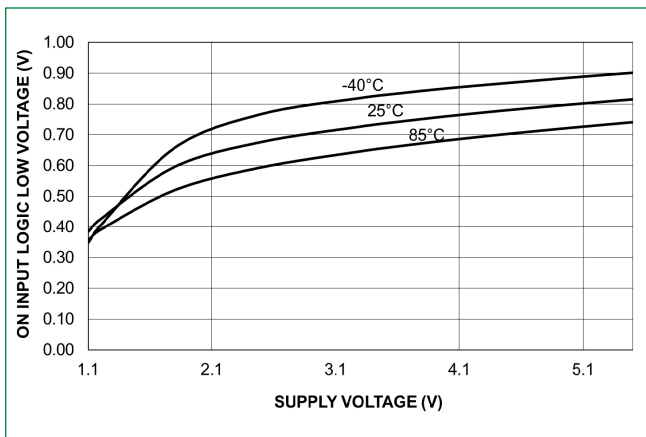
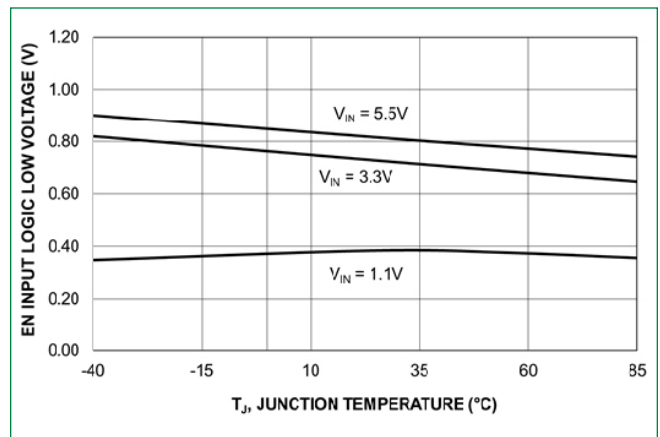

Figure 10 - EN Input Logic Low Threshold Vs. Temperature



LQ05021QCS4

5 V, 2 A Ultra Low Consumption Load Switch With Slew Rate Control

Figure 11 - V_{OUT} Rise Time vs. Temperature

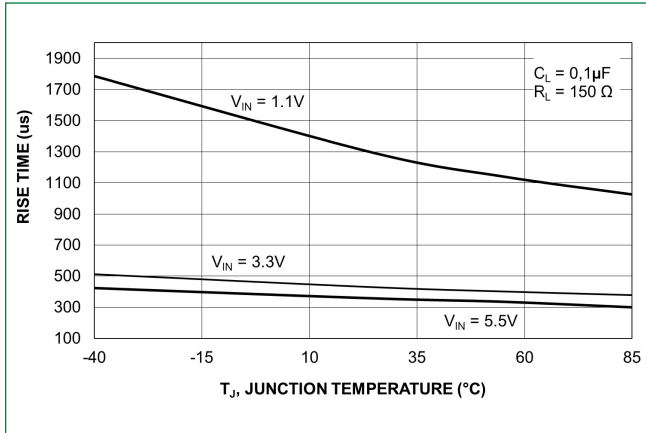

Figure 12 - Turn-On Delay Time vs. Temperature

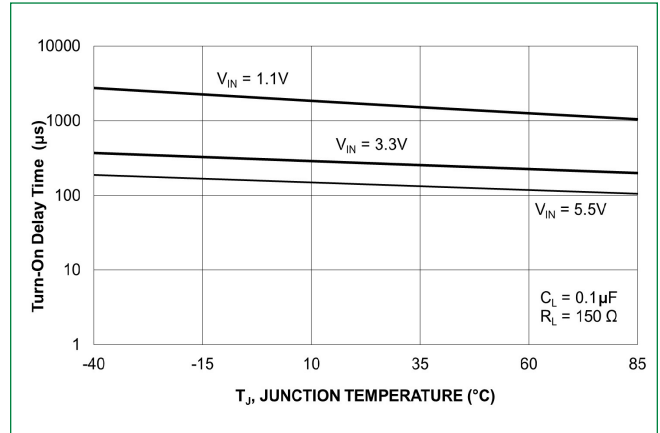

Figure 13 - Pull-down Resistance vs. Temperature

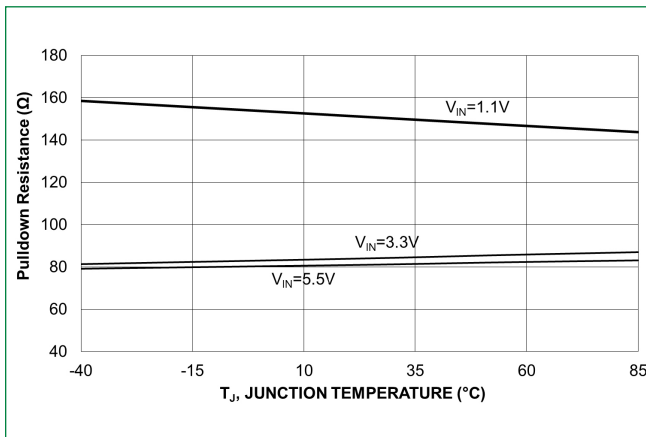

Figure 14 - Enable Input Current vs. Temperature

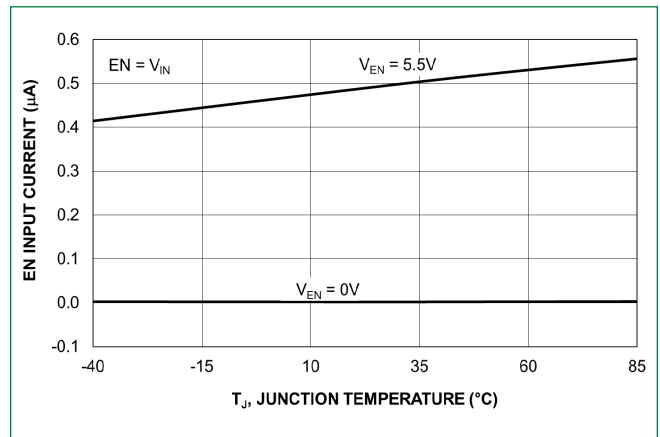

Figure 15 - Turn-On Response
 $V_{IN} = 3.3V$, $C_{IN} = 1.0\mu F$, $C_{OUT} = 0.1\mu F$, $R_L = 150\Omega$

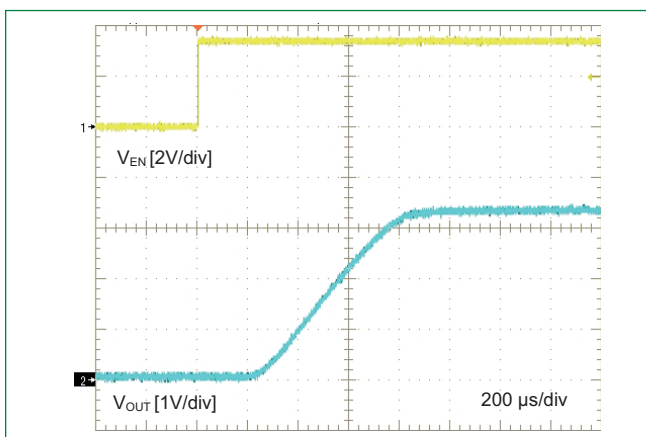
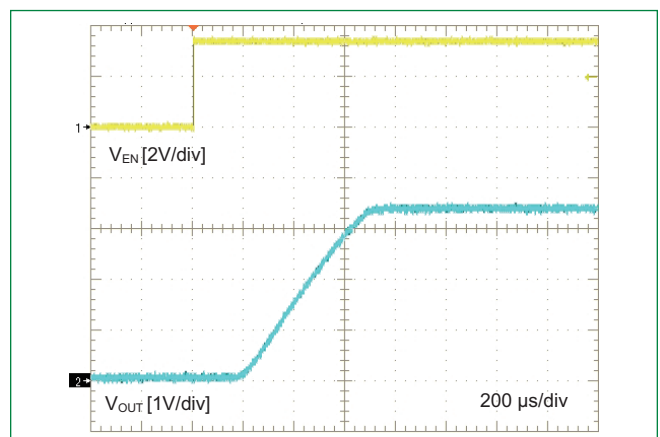

Figure 16 - Turn-On Response
 $V_{IN} = 3.3V$, $C_{IN} = 1.0\mu F$, $C_{OUT} = 0.1\mu F$, $R_L = 500\Omega$



LQ05021QCS4

5 V, 2 A Ultra Low Consumption Load Switch With Slew Rate Control

Figure 17 - Turn-Off Response, Output Discharge
 $V_{IN} = 3.3\text{ V}$, $C_{IN} = 1.0\ \mu\text{F}$, $C_{OUT} = 0.1\ \mu\text{F}$, $R_L = 150\ \Omega$

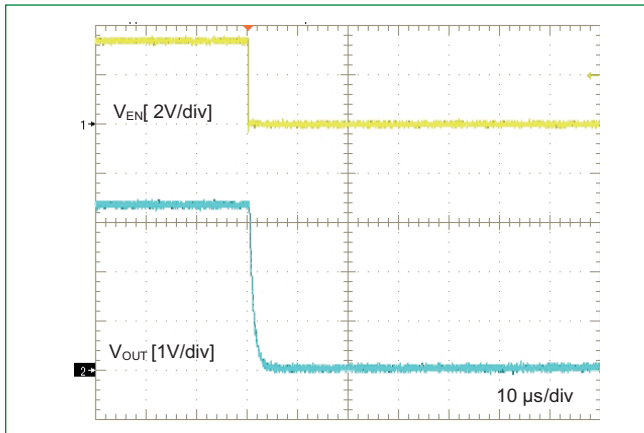
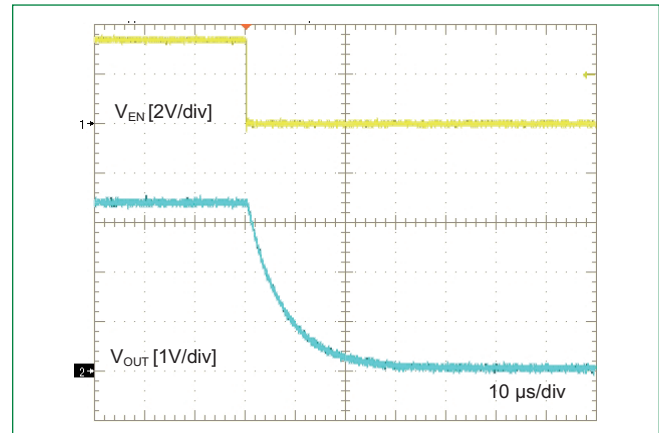

Figure 18 - Turn-Off Response, Output Discharge
 $V_{IN} = 3.3\text{ V}$, $C_{IN} = 1.0\ \mu\text{F}$, $C_{OUT} = 0.1\ \mu\text{F}$, $R_L = 500\ \Omega$



Application Information

The LQ05021QCS4 is a highly efficient integrated load switch with a 2 A capacity. It allows a fixed slew rate control to limit inrush current when activated. This device works with a wide input voltage range, from 1.1 V to 5.5 V, and has minimal on-resistance to reduce power loss. When it is off, it has very low leakage current, saving power resources. It is in a chip scale size package at 0.77 mm x 0.77 mm x 0.46 mm with 4 bumps at a 0.4 mm pitch make it ideal for efficient manufacturing in the space-saving required applications.

Input Capacitor

The proper functioning of the LQ05021QCS4 needs the presence of an input capacitor. Consider using a 1 μF capacitor positioned near the VIN pin to address voltage fluctuations on the input power rail that may occur as a result of transient inrush current during startup. To reduce the extent of the input voltage drop, suggest to use a higher input capacitor value.

Output Capacitor

It is advisable to employ an output capacitor to minimize voltage undershoot on the output pin during switch-off.

Voltage undershoot may arise due to parasitic inductance from board traces or deliberate load inductances. In the presence of load inductances, utilizing an output capacitor can enhance output voltage stability and overall system reliability. Position the C_{OUT} capacitor in close proximity to the V_{OUT} and GND pins.

EN pin

The device can be turned on by setting the EN pin to a high level. Be aware that there is an internal pull-down resistor in EN pin which can pull the primary switch to "off state" as long as no EN signal from an external controller is applied.

Output Discharge Function

The device incorporates an internal discharge N-channel FET switch located at the VOUT pin. When the EN signal switches the primary power FET to an off state, the N-channel switch activates to rapidly discharge the output capacitor.

Board Layout

To minimize the impact of parasitic inductance, it is advisable to keep all traces as short as possible. Using wider traces for V_{IN} , V_{OUT} , and GND is recommended to mitigate parasitic effects during dynamic operations and enhance thermal efficiency under high load currents.

LQ05021QCS4

5 V, 2 A Ultra Low Consumption Load Switch With Slew Rate Control

Dimensions

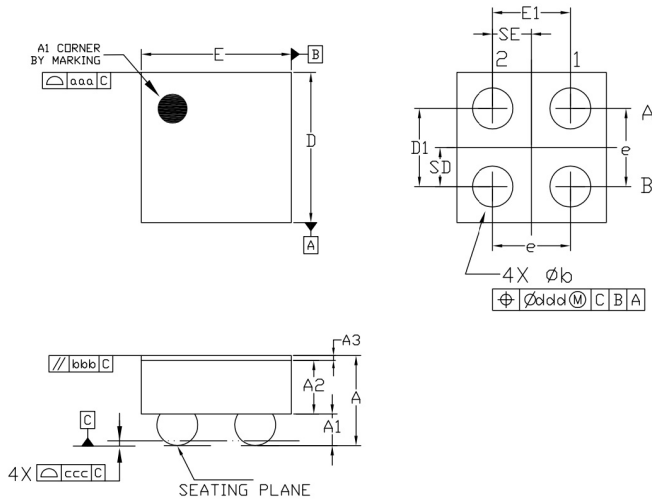

Dimension	Millimeters		
	Min	Nom	Max
A	0.410	0.460	0.510
A1	0.135	0.160	0.185
A2	0.250	0.275	0.300
A3	0.020	0.025	0.030
D	0.755	0.770	0.785
E	0.755	0.770	0.785
D1	0.350	0.400	0.450
E1	0.350	0.400	0.450
B	0.170	0.210	0.250
E	0.400 BSC		
SD	0.200 BSC		
SE	0.200 BSC		
Tol. of Form & Position			
aaa	0.100		
bbb	0.100		
ccc	0.050		
ddd	0.050		

Part Numbering

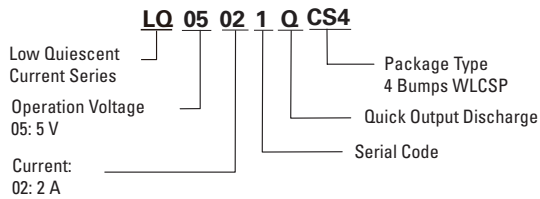

Part Marking

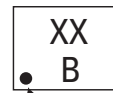

Pin 1 mark
 B = Device Code
 XX = Lot Run Code

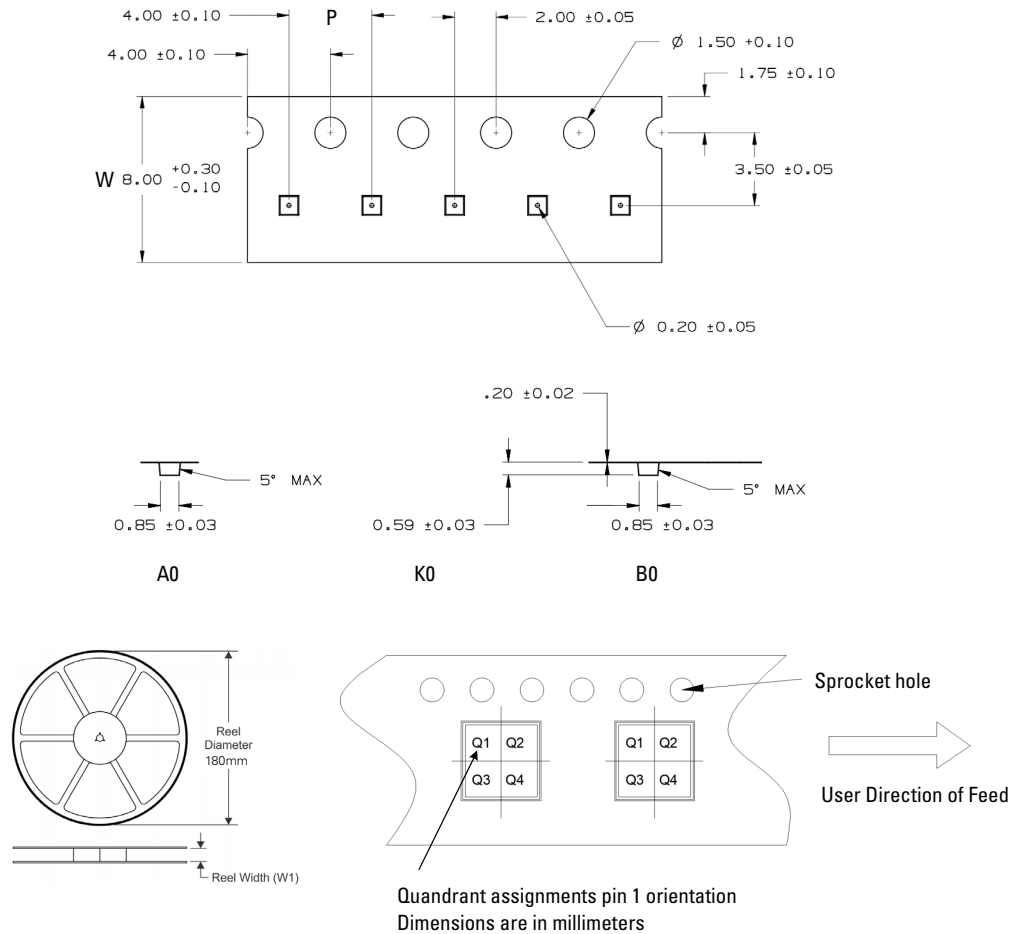
LQ05021QCS4**5 V, 2 A Ultra Low Consumption Load Switch With Slew Rate Control****Carrier Tape & Reel Specification**

Device	Package	Pins	SPQ	Reel Diameter	Reel Width W1	A0	B0	K0	P	W	Pin1
LQ05021QCS4	4 Bumps WLCSP	4	4000	180	9	0.85	0.85	0.59	4	8	Q1

Product Disclaimer - Littelfuse products are not designed for, and shall not be used for, any purpose (including, without limitation, automotive, military, aerospace, medical, life-saving, life-sustaining or nuclear facility applications, devices intended for surgical implant into the body, or any other application in which the failure or lack of desired operation of the product may result in personal injury, death, or property damage) other than those expressly set forth in applicable Littelfuse product documentation. Warranties granted by Littelfuse shall be deemed void for products used for any purpose not expressly set forth in applicable Littelfuse documentation. Littelfuse shall not be liable for any claims or damages arising out of products used in applications not expressly intended by Littelfuse as set forth in applicable Littelfuse documentation. The sale and use of Littelfuse products is subject to Littelfuse Terms and Conditions of Sale, unless otherwise agreed by Littelfuse. "Littelfuse" includes Littelfuse, Inc., and all of its affiliate entities.

<https://www.littelfuse.com/legal/disclaimers/product-disclaimer.aspx>