

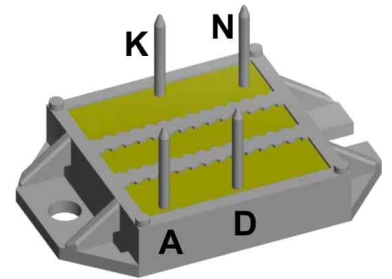
Standard Rectifier Module

1~ Rectifier	
V_{RRM}	= 1200 V
I_{DAV}	= 70 A
I_{FSM}	= 550 A

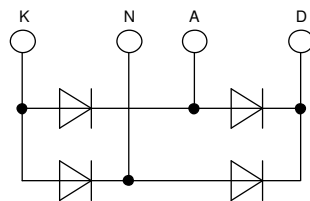
1~ Rectifier Bridge

Part number

VBO68-12NO7



 E72873



Features / Advantages:

- Package with DCB ceramic
- Improved temperature and power cycling
- Planar passivated chips
- Very low forward voltage drop
- Very low leakage current

Applications:

- Diode for main rectification
- For one phase bridge configurations
- Supplies for DC power equipment
- Input rectifiers for PWM inverter
- Battery DC power supplies
- Field supply for DC motors

Package: ECO-PAC1

- Isolation Voltage: 3000 V~
- Industry standard outline
- RoHS compliant
- Soldering pins for PCB mounting
- Height: 9 mm
- Base plate: DCB ceramic
- Reduced weight
- Advanced power cycling

Disclaimer Notice

Information furnished is believed to be accurate and reliable. However, users should independently evaluate the suitability of and test each product selected for their own applications. Littelfuse products are not designed for, and may not be used in, all applications. Read complete Disclaimer Notice at www.littelfuse.com/disclaimer-electronics.

Rectifier				Ratings			
Symbol	Definition	Conditions		min.	typ.	max.	Unit
V_{RSM}	max. non-repetitive reverse blocking voltage					1300	V
V_{RRM}	max. repetitive reverse blocking voltage					1200	V
I_R	reverse current	$V_R = 1200$ V	$T_{VJ} = 25^\circ\text{C}$			40	μA
		$V_R = 1200$ V	$T_{VJ} = 150^\circ\text{C}$			1.5	mA
V_F	forward voltage drop	$I_F = 30$ A	$T_{VJ} = 25^\circ\text{C}$			1.14	V
		$I_F = 60$ A				1.32	V
		$I_F = 30$ A	$T_{VJ} = 125^\circ\text{C}$			1.06	V
		$I_F = 60$ A				1.30	V
I_{DAV}	bridge output current	$T_C = 105^\circ\text{C}$ rectangular	$T_{VJ} = 150^\circ\text{C}$ d = 0.5			70	A
V_{FO}	threshold voltage	} for power loss calculation only				0.81	V
r_F	slope resistance					7.8	m Ω
R_{thJC}	thermal resistance junction to case					0.9	K/W
R_{thCH}	thermal resistance case to heatsink				0.4		K/W
P_{tot}	total power dissipation			$T_C = 25^\circ\text{C}$		135	W
I_{FSM}	max. forward surge current	t = 10 ms; (50 Hz), sine	$T_{VJ} = 45^\circ\text{C}$			550	A
		t = 8,3 ms; (60 Hz), sine	$V_R = 0$ V			595	A
		t = 10 ms; (50 Hz), sine	$T_{VJ} = 150^\circ\text{C}$			470	A
		t = 8,3 ms; (60 Hz), sine	$V_R = 0$ V			505	A
I^2t	value for fusing	t = 10 ms; (50 Hz), sine	$T_{VJ} = 45^\circ\text{C}$			1.52	kA ² s
		t = 8,3 ms; (60 Hz), sine	$V_R = 0$ V			1.48	kA ² s
		t = 10 ms; (50 Hz), sine	$T_{VJ} = 150^\circ\text{C}$			1.11	kA ² s
		t = 8,3 ms; (60 Hz), sine	$V_R = 0$ V			1.06	kA ² s
C_J	junction capacitance	$V_R = 400$ V; f = 1 MHz		$T_{VJ} = 25^\circ\text{C}$		18	pF



Package ECO-PAC1		Ratings				
Symbol	Definition	Conditions	min.	typ.	max.	Unit
I_{RMS}	RMS current	per terminal			100	A
T_{VJ}	virtual junction temperature		-40		150	°C
T_{op}	operation temperature		-40		125	°C
T_{stg}	storage temperature		-40		125	°C
Weight				19		g
M_D	mounting torque		1.4		2	Nm
$d_{Spp/App}$	creepage distance on surface / striking distance through air	terminal to terminal	6.0			mm
$d_{Spb/Apb}$		terminal to backside	10.0			mm
V_{ISOL}	isolation voltage	t = 1 second	3000			V
		t = 1 minute	2500			V



Ordering	Ordering Number	Marking on Product	Delivery Mode	Quantity	Code No.
Standard	VBO68-12NO7	VBO68-12NO7	Box	25	479578

Equivalent Circuits for Simulation

* on die level

$T_{VJ} = 150^{\circ}C$

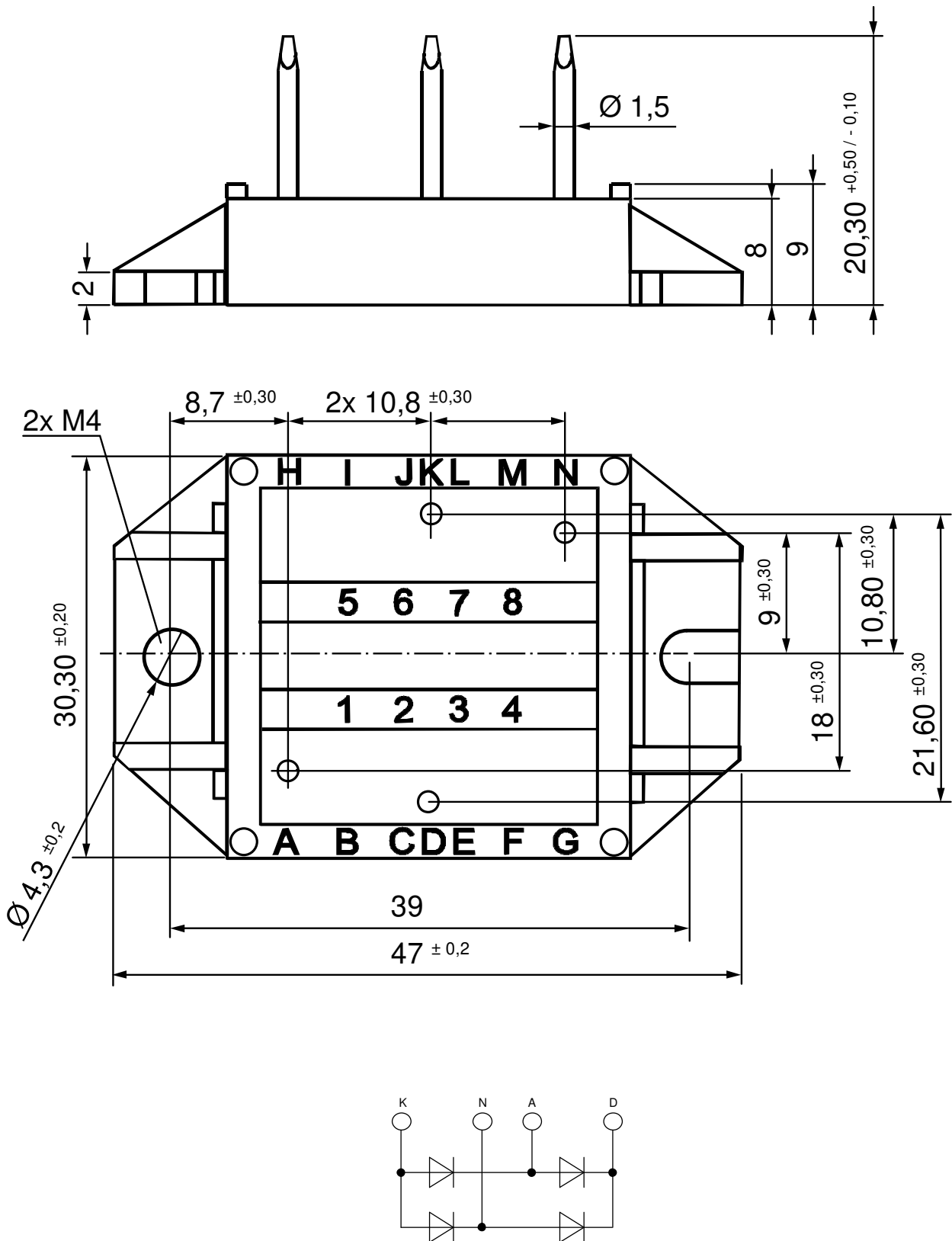


Rectifier

$V_{0\ max}$	threshold voltage	0.81	V
$R_{0\ max}$	slope resistance *	6.6	mΩ



Outlines ECO-PAC1



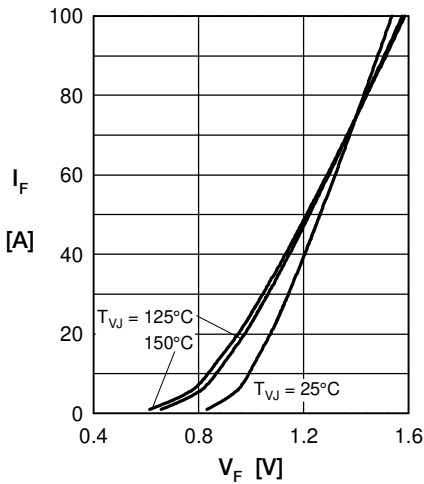
Rectifier


Fig. 1 Forward current versus voltage drop per diode

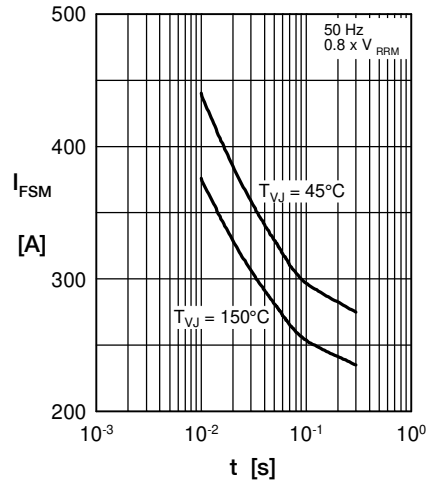


Fig. 2 Surge overload current

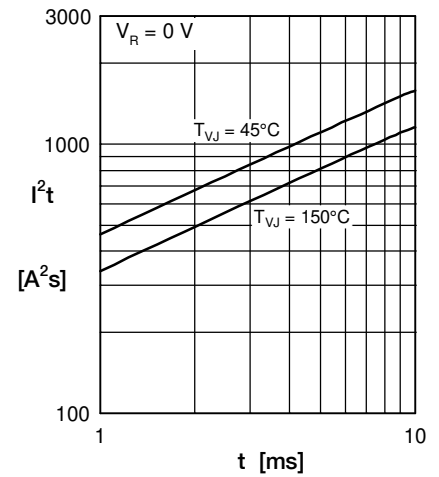
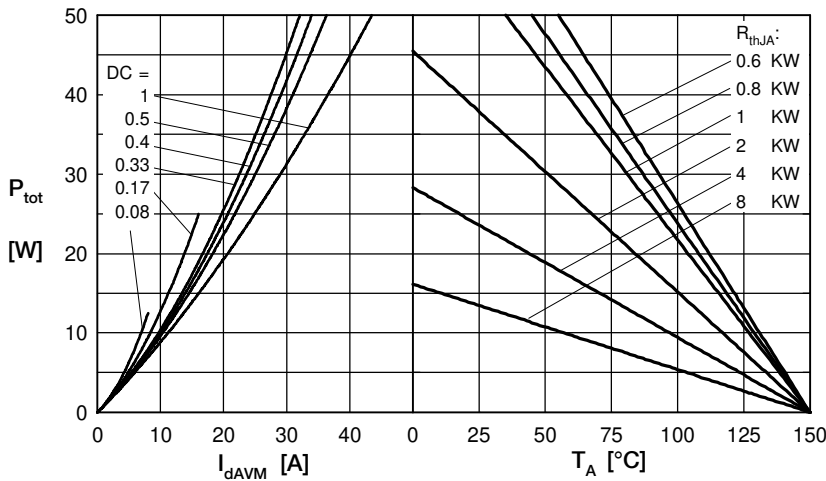

 Fig. 3 I^2t versus time per diode


Fig. 4 Power dissipation vs. direct output current & ambient temperature

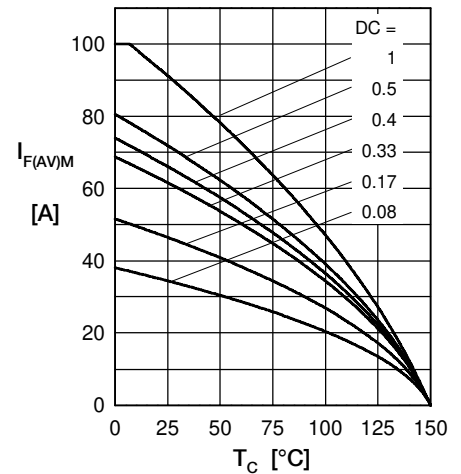


Fig. 5 Max. forward current vs. case temperature

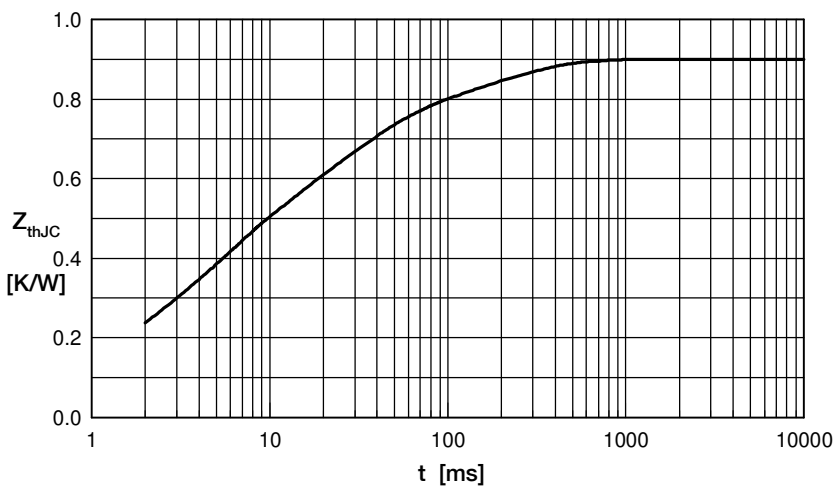


Fig. 6 Transient thermal impedance junction to case

 Constants for Z_{thJC} calculation:

i	R_{th} (K/W)	t_i (s)
1	0.0607	0.000
2	0.1230	0.00256
3	0.2330	0.0045
4	0.3230	0.0242
5	0.1628	0.18