

Converter - Brake - Inverter Module (CBI3) with Trench IGBT technology

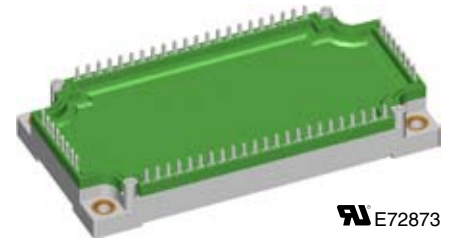
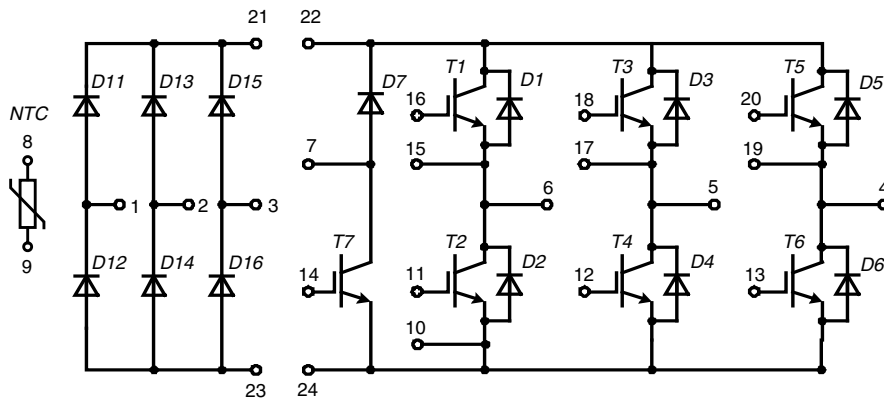

E72873

| Three Phase Rectifier | Brake Chopper | Three Phase Inverter |
|----------------------------|-------------------------------|-------------------------------|
| $V_{RRM} = 2200 \text{ V}$ | $V_{CES} = 1700 \text{ V}$ | $V_{CES} = 1700 \text{ V}$ |
| $I_{FAVM} = 60 \text{ A}$ | $I_{C25} = 48 \text{ A}$ | $I_{C25} = 74 \text{ A}$ |
| $I_{FSM} = 550 \text{ A}$ | $V_{CE(sat)} = 2.1 \text{ V}$ | $V_{CE(sat)} = 2.0 \text{ V}$ |

| Input Rectifier Bridge D11 - D16 | | | |
|----------------------------------|---|-----------------|---|
| Symbol | Conditions | Maximum Ratings | |
| V_{RRM} | | 2200 | V |
| I_{FAV} | $T_C = 80^\circ\text{C}$; sine 180° | 40 | A |
| I_{DAVM} | $T_C = 80^\circ\text{C}$; rectangular; $d = 1/3$; bridge | 130 | A |
| I_{FSM} | $T_C = 25^\circ\text{C}$; $t = 10 \text{ ms}$; sine 50 Hz | 550 | A |
| P_{tot} | $T_C = 25^\circ\text{C}$ | 110 | W |

| Symbol | Conditions | Characteristic Values | | | | |
|---|------------------------|------------------------------|------|------|------|-----|
| | | min. | typ. | max. | | |
| $(T_{VJ} = 25^\circ\text{C}, \text{ unless otherwise specified})$ | | | | | | |
| V_F | $I_F = 50 \text{ A}$; | $T_{VJ} = 25^\circ\text{C}$ | | 1.25 | 1.5 | V |
| | | $T_{VJ} = 125^\circ\text{C}$ | | 1.25 | | V |
| I_R | $V_R = V_{RRM}$; | $T_{VJ} = 25^\circ\text{C}$ | | 0.8 | 0.05 | mA |
| | | $T_{VJ} = 125^\circ\text{C}$ | | | | mA |
| R_{thJC} | (per diode) | | | | 1.1 | K/W |

Application: AC motor drives with

- Input from single or three phase grid
- Three phase synchronous or asynchronous motor
- Electric braking operation

Features

- High level of integration - only one power semiconductor module required for the whole drive
- IGBT technology with low saturation voltage, low switching losses and tail current, high RBSOA and short circuit ruggedness
- Epitaxial free wheeling diodes with Hiperfast and soft reverse recovery
- Industry standard package with insulated copper base plate and soldering pins for PCB mounting
- Temperature sense included

| Output Inverter T1 - T6 | | | |
|-------------------------|--|-----------------|---|
| Symbol | Conditions | Maximum Ratings | |
| V_{CES} | $T_{VJ} = 25^{\circ}\text{C}$ to 150°C | 1700 | V |
| V_{GES} | Continuous | ± 20 | V |
| I_{C25} | $T_C = 25^{\circ}\text{C}$ | 74 | A |
| I_{C80} | $T_C = 80^{\circ}\text{C}$ | 53 | A |
| I_{CM} | $T_C = 80^{\circ}\text{C}$; $t_p = 1$ ms | 100 | A |
| P_{tot} | $T_C = 25^{\circ}\text{C}$ | 290 | W |

| Symbol | Conditions | Characteristic Values | | | | |
|--|---|--|------|------|---------------|---|
| | | (T _{VJ} = 25°C, unless otherwise specified) | | | | |
| | | min. | typ. | max. | | |
| $V_{CE(sat)}$ | $I_C = 50$ A; $V_{GE} = 15$ V | $T_{VJ} = 25^{\circ}\text{C}$ | | 2.0 | 2.4 | V |
| | | $T_{VJ} = 125^{\circ}\text{C}$ | | 2.4 | | V |
| $V_{GE(th)}$ | $I_C = 2$ mA; $V_{GE} = V_{CE}$ | 5 | | 6.5 | V | |
| I_{CES} | $V_{CE} = V_{CES}$; $V_{GE} = 0$ V | | | 0.4 | mA | |
| | | | 1.0 | | mA | |
| I_{GES} | $V_{CE} = 0$ V; $V_{GE} = \pm 20$ V | | | 400 | nA | |
| C_{ies} | $V_{CE} = 25$ V; $V_{GE} = 0$ V; $f = 1$ MHz | | 4.4 | | nF | |
| Q_{Gon} | $V_{CE} = 900$ V; $V_{GE} = 15$ V; $I_C = 75$ A | | 600 | | nC | |
| $t_{d(on)}$ t_r $t_{d(off)}$ t_f E_{on} E_{off} | Inductive load, $T_{VJ} = 125^{\circ}\text{C}$ $V_{CE} = 900$ V; $I_C = 50$ A $V_{GE} = \pm 15$ V; $R_G = 8$ Ω | | 250 | | ns | |
| | | | 50 | | ns | |
| | | | 500 | | ns | |
| | | | 480 | | ns | |
| | | | 11 | | mJ | |
| | | | 12 | | mJ | |
| RBSOA | $I_C = I_{CM}$; $V_{GE} = 15$ V $R_G = 27$ Ω ; $T_{VJ} = 125^{\circ}\text{C}$ | $V_{CEK} \leq V_{CES} - L_S di/dt$ | | | V | |
| t_{SC} (SCSOA) | $V_{CE} = 1000$ V; $V_{GE} = \pm 15$ V; $R_G = 27$ Ω $t_p \leq 10$ μs ; non-repetitive; $T_{VJ} = 125^{\circ}\text{C}$ | | 10 | | μs | |
| R_{thJC} | | | 0.43 | | K/W | |

| Output Inverter D1 - D6 | | | |
|-------------------------|----------------------------|-----------------|---|
| Symbol | Conditions | Maximum Ratings | |
| I_{F25} | $T_C = 25^{\circ}\text{C}$ | 56 | A |
| I_{F80} | $T_C = 80^{\circ}\text{C}$ | 39 | A |

| Symbol | Conditions | Characteristic Values | | | | |
|------------|--|--------------------------------|------|---------------|-----|---|
| | | min. | typ. | max. | | |
| V_F | $I_F = 50$ A; | $T_{VJ} = 25^{\circ}\text{C}$ | | 2.0 | 2.4 | V |
| | | $T_{VJ} = 125^{\circ}\text{C}$ | | 2.0 | | V |
| I_{RM} | $I_F = 50$ A; $di_F/dt = -1200$ A/ μs ; $T_{VJ} = 125^{\circ}\text{C}$; $V_R = 900$ V; $V_{GE} = 0$ V | | 80 | | A | |
| Q_{rr} | | 20 | | μC | | |
| t_{rr} | | 650 | | ns | | |
| E_{rec} | | 9 | | mJ | | |
| R_{thJC} | (per diode) | | | 0.65 | K/W | |

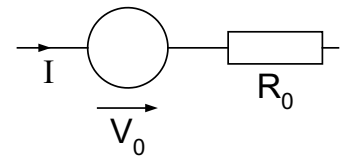
Equivalent Circuits for Simulation
Conduction

IGBT (typ. at $V_{GE} = 15$ V; $T_J = 125^{\circ}\text{C}$)
T1-T6

$V_0 = 1.0$ V; $R_0 = 25$ m Ω

T7

$V_0 = 1.0$ V; $R_0 = 28$ m Ω

Diode (typ. at $T_J = 125^{\circ}\text{C}$)
D1-D6

$V_0 = 1.35$ V; $R_0 = 15$ m Ω

D7

$V_0 = 1.65$ V; $R_0 = 37$ m Ω

D11-D16

$V_0 = 0.83$ V; $R_0 = 4.1$ m Ω

| Brake Chopper T7 | | | |
|-------------------------|--|------------------------|---|
| Symbol | Conditions | Maximum Ratings | |
| V_{CES} | $T_{VJ} = 25^{\circ}\text{C}$ to 150°C | 1700 | V |
| V_{GES} | Continuous | ± 20 | V |
| I_{C25} | $T_C = 25^{\circ}\text{C}$ | 48 | A |
| I_{C80} | $T_C = 80^{\circ}\text{C}$ | 34 | A |
| I_{CM} | $T_C = 80^{\circ}\text{C}$; $t_p = 1$ ms | 60 | A |
| P_{tot} | $T_C = 25^{\circ}\text{C}$ | 200 | W |

| Symbol | Conditions | Characteristic Values | | | | |
|----------------------------|--|---|------------------------------------|-------------|-----|---------------|
| | | $(T_{VJ} = 25^{\circ}\text{C}, \text{ unless otherwise specified})$ | | | | |
| | | min. | typ. | max. | | |
| $V_{CE(sat)}$ | $I_C = 30$ A; $V_{GE} = 15$ V | | $T_{VJ} = 25^{\circ}\text{C}$ | 1.9 | 2.2 | V |
| | | | $T_{VJ} = 125^{\circ}\text{C}$ | 2.1 | | V |
| $V_{GE(th)}$ | $I_C = 2$ mA; $V_{GE} = V_{CE}$ | 5 | | 6.5 | V | |
| I_{CES} | $V_{CE} = V_{CES}$; $V_{GE} = 0$ V | | $T_{VJ} = 25^{\circ}\text{C}$ | | 0.3 | mA |
| | | | $T_{VJ} = 125^{\circ}\text{C}$ | 0.6 | | mA |
| I_{GES} | $V_{CE} = 0$ V; $V_{GE} = \pm 20$ V | | | 400 | nA | |
| C_{iss} | $V_{CE} = 25$ V; $V_{GE} = 0$ V; $f = 1$ MHz | | 4.4 | | nF | |
| Q_{Gon} | $V_{CE} = 900$ V; $V_{GE} = 15$ V; $I_C = 30$ A | | 600 | | nC | |
| $t_{d(on)}$ | Inductive load, $T_{VJ} = 125^{\circ}\text{C}$ $V_{CE} = 900$ V; $I_C = 30$ A $V_{GE} = \pm 15$ V; $R_G = 27$ Ω | | | 165 | | ns |
| t_r | | | | 40 | | ns |
| $t_{d(off)}$ | | | | 700 | | ns |
| t_f | | | | 400 | | ns |
| E_{off} | | | | 7 | | mJ |
| E_{on} | | | | 6 | | mJ |
| RBSOA | $I_C = I_{CM}$; $V_{GE} = 15$ V $R_G = 27$ Ω ; $T_{VJ} = 125^{\circ}\text{C}$ | | $V_{CEK} \leq V_{CES} - L_S di/dt$ | | | V |
| t_{SC} (SCSOA) | $V_{CE} = 900$ V; $V_{GE} = \pm 15$ V; $R_G = 45$ Ω $t_p \leq 10$ μs ; non-repetitive; $T_{VJ} = 125^{\circ}\text{C}$ | | 10 | | | μs |
| R_{thJC} | | | | 0.62 | | K/W |

| Brake Chopper D7 | | | |
|-------------------------|--|------------------------|---|
| Symbol | Conditions | Maximum Ratings | |
| V_{RRM} | $T_{VJ} = 25^{\circ}\text{C}$ to 150°C | 1700 | V |
| I_{F25} | $T_C = 25^{\circ}\text{C}$ | 30 | A |
| I_{F80} | $T_C = 80^{\circ}\text{C}$ | 21 | A |

| Symbol | Conditions | Characteristic Values | | | | |
|---------------|---|------------------------------|--------------------------------|-------------|-----|---|
| | | min. | typ. | max. | | |
| V_F | $I_F = 30$ A; | | $T_{VJ} = 25^{\circ}\text{C}$ | 2.5 | 3.3 | V |
| | | | $T_{VJ} = 125^{\circ}\text{C}$ | 2.6 | | V |
| I_R | $V_R = V_{RRM}$; | | | 0.05 | mA | |
| | | | $T_{VJ} = 125^{\circ}\text{C}$ | 0.2 | mA | |
| I_{RM} | $I_F = 30$ A; $di_F/dt = -800$ A/ μs ; $T_{VJ} = 125^{\circ}\text{C}$ $V_R = 900$ V | | | 35 | A | |
| t_{rr} | | | | 700 | ns | |
| R_{thJC} | (per diode) | | | 0.9 | K/W | |

Temperature Sensor NTC

| Symbol | Conditions | Characteristic Values | | | |
|-------------|--------------------------|-----------------------|------|------|------------|
| | | min. | typ. | max. | |
| R_{25} | $T = 25^{\circ}\text{C}$ | 4.75 | 5.0 | 5.25 | k Ω |
| $B_{25/50}$ | | | 3375 | | K |

Module

| Symbol | Conditions | Maximum Ratings | |
|-----------|--|-----------------|--------------------|
| T_{VJ} | operating | -40...+125 | $^{\circ}\text{C}$ |
| T_{JM} | | +150 | $^{\circ}\text{C}$ |
| T_{stg} | | -40...+125 | $^{\circ}\text{C}$ |
| V_{ISO} | $I_{ISOL} \leq 1 \text{ mA}; 50/60 \text{ Hz}; 1 \text{ min.}$ | 3400 | V~ |
| M_d | Mounting torque (M5) | 3 - 6 | Nm |

| Symbol | Conditions | Characteristic Values | | |
|------------------|------------------------------|-----------------------|------|------------|
| | | min. | typ. | max. |
| $R_{therm-chip}$ | Resistance terminal to chip | | 7 | m Ω |
| d_s | Creepage distance on surface | 12.7 | | mm |
| d_A | Strike distance in air | 9.6 | | mm |
| R_{thCH} | with heatsink compound | | 0.02 | K/W |
| Weight | | | 300 | g |

Dimensions in mm (1 mm = 0.0394")

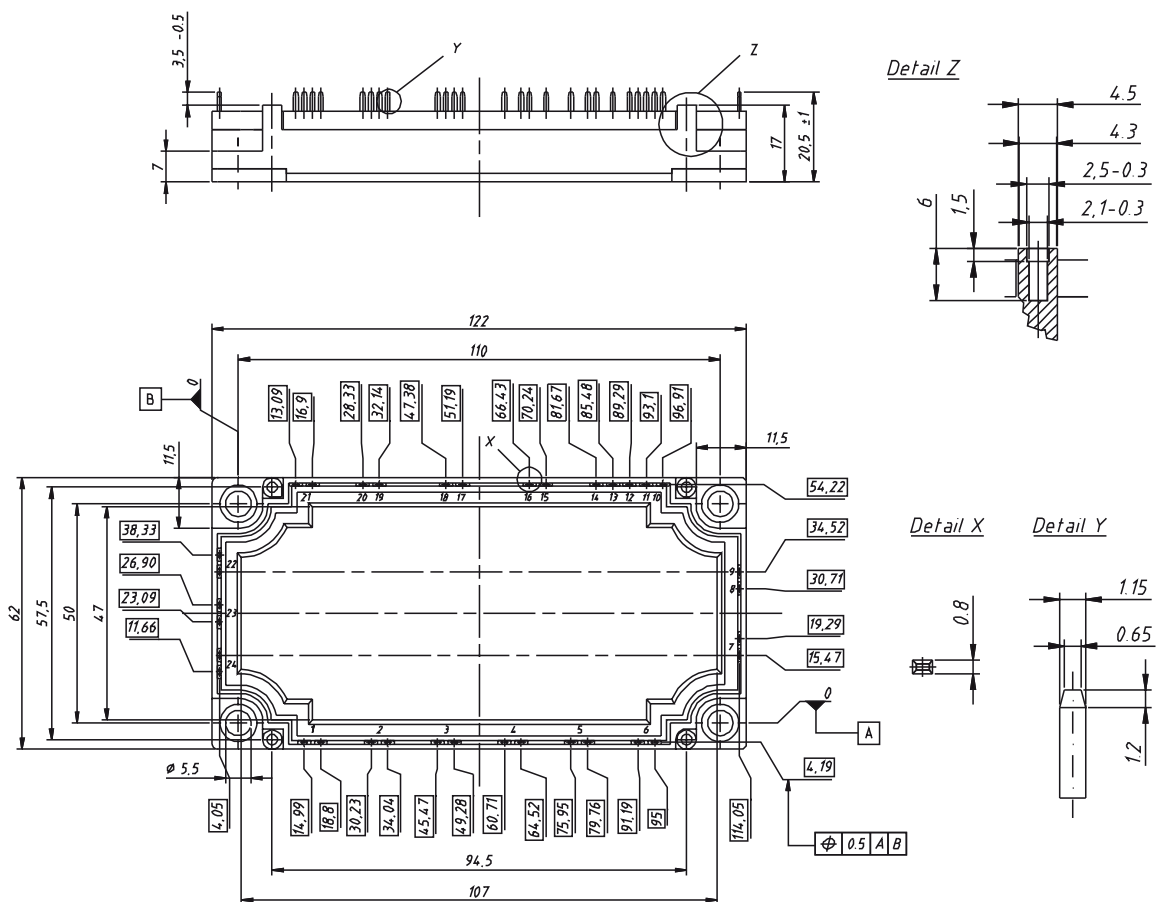

IXYS reserves the right to change limits, test conditions and dimensions.

20090826a

© 2009 IXYS All rights reserved

Input Rectifier Bridge D11 - D16

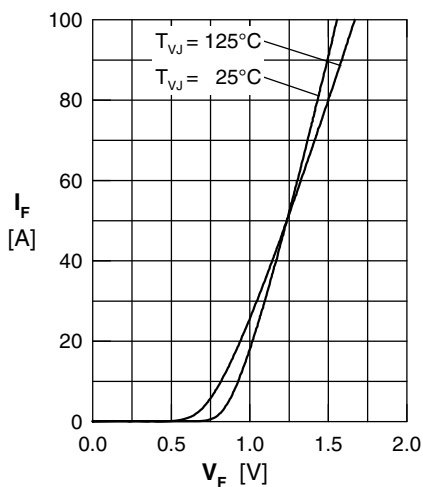

Fig. 1 Typ. forward current vs. voltage drop per diode

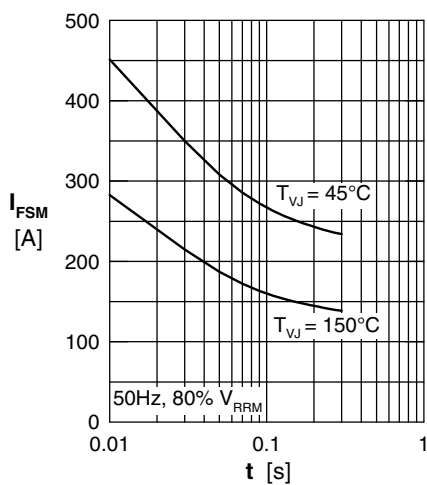

Fig. 2 Surge overload current

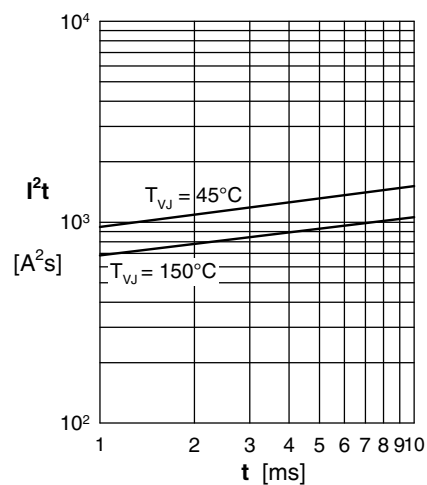

Fig. 3 I^2t versus time per diode

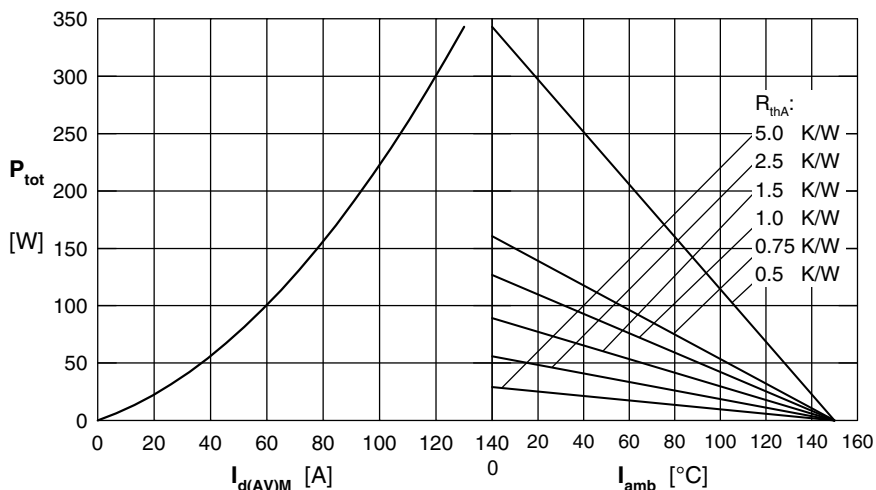

Fig. 4 Power dissipation versus direct output current & ambient temperature, sin 180°

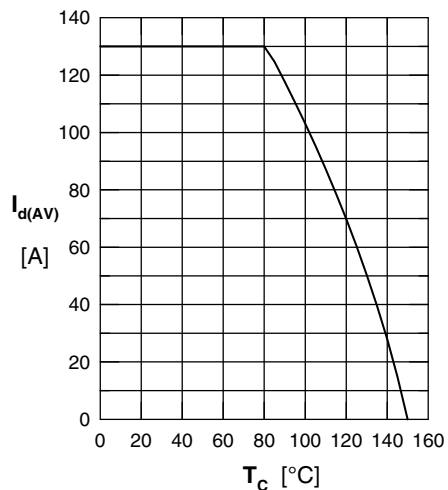

Fig. 5 Max. forward current vs. case temperature

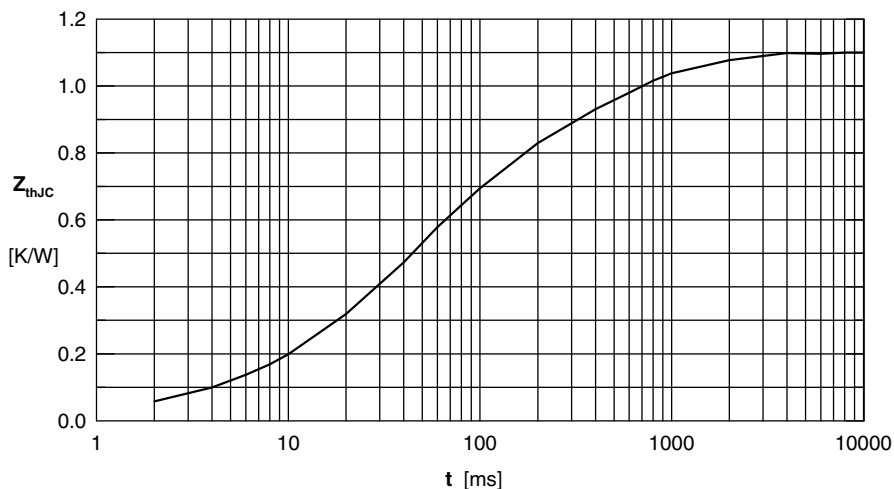
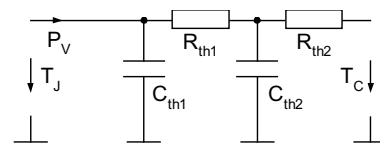

Fig. 6 Transient thermal impedance junction to case



| | R_i | τ_i |
|---|-------|----------|
| 1 | 0.06 | 0.0085 |
| 2 | 0.024 | 0.001 |
| 3 | 0.586 | 0.045 |
| 4 | 0.114 | 0.85 |
| 5 | 0.317 | 0.35 |

Output Inverter T1 - T6 / D1 - D6

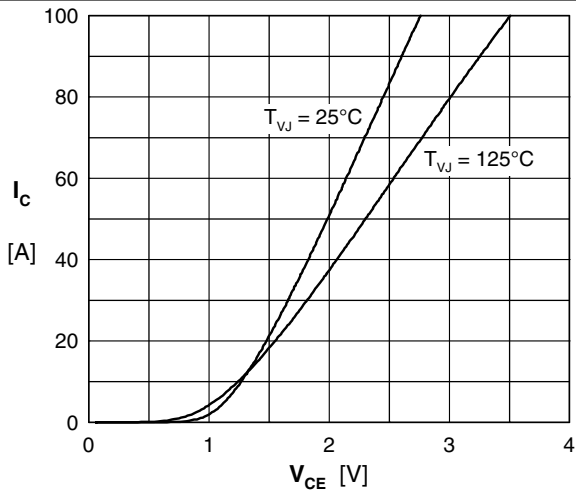

Fig. 7 Typical output characteristic

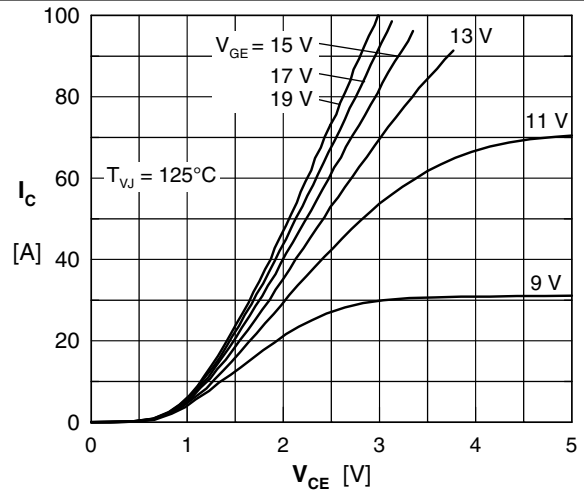

Fig. 8 Typical output characteristic

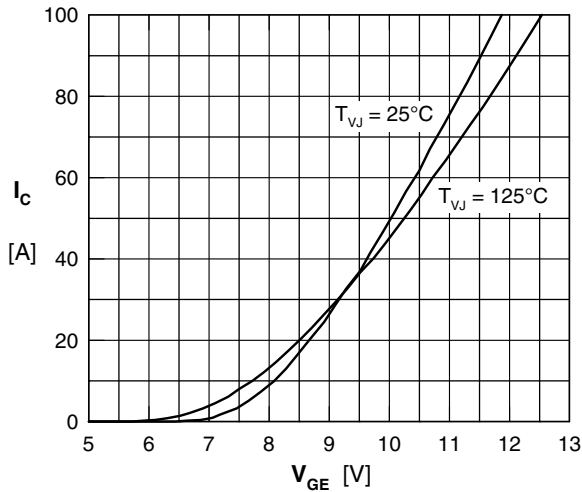

Fig. 9 Typical transfer characteristic

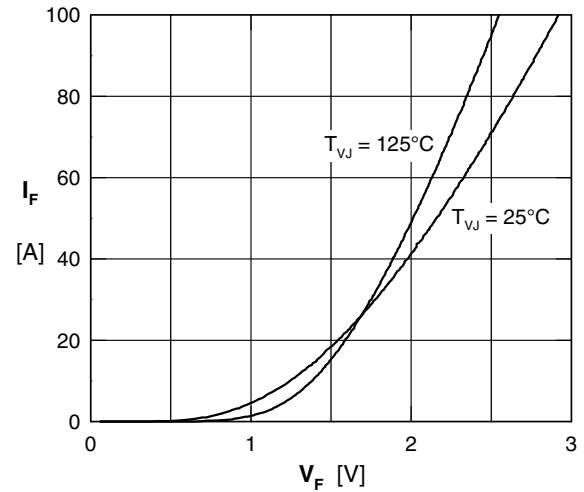

Fig. 10 Typical forward characteristic of free wheeling diode

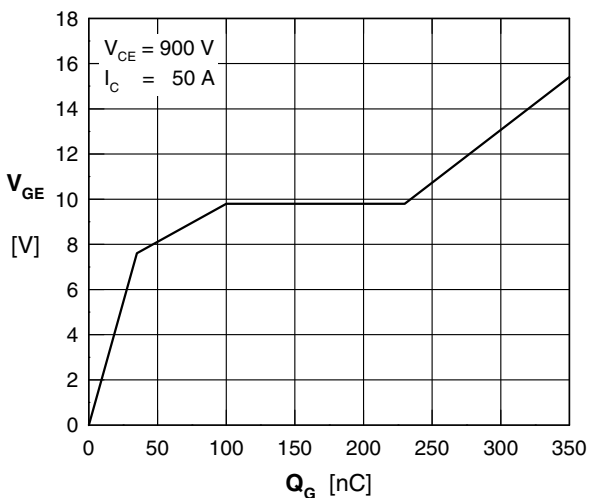

Fig. 11 Typical turn on gate charge

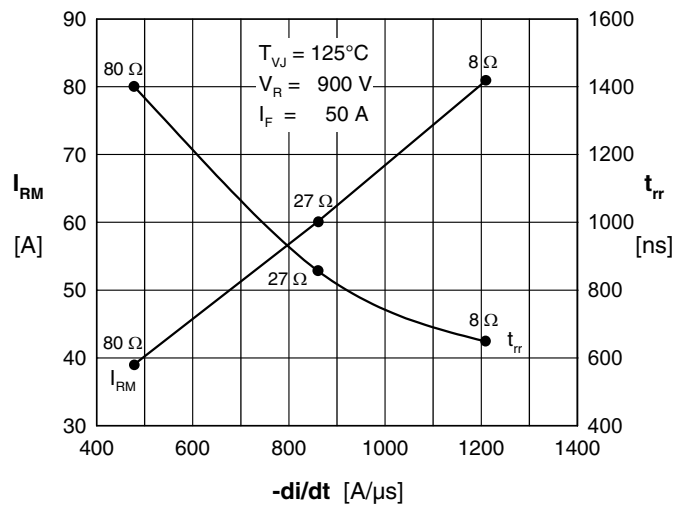

Fig. 12 Typ. turn-off characteristics of free wheeling diode

IXYS reserves the right to change limits, test conditions and dimensions.

20090826a

Output Inverter T1 - T6 / D1 - D6

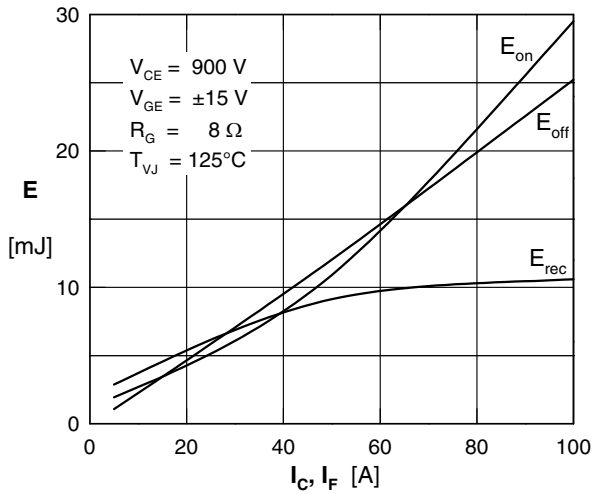

Fig. 13 Typ. turn on energy & switching times versus collector current

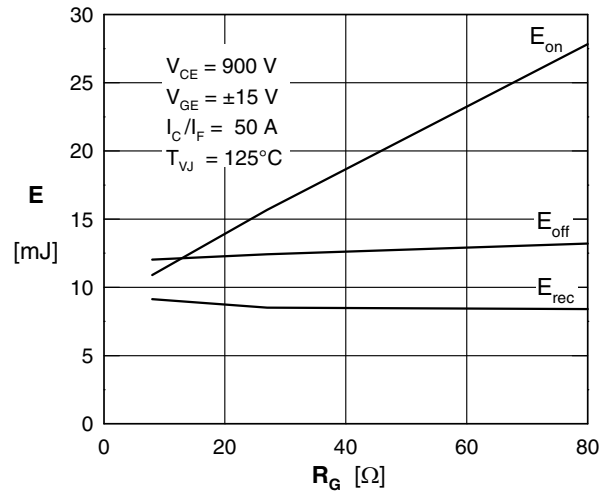

Fig. 14 Typ. turn off energy and switching times versus collector current

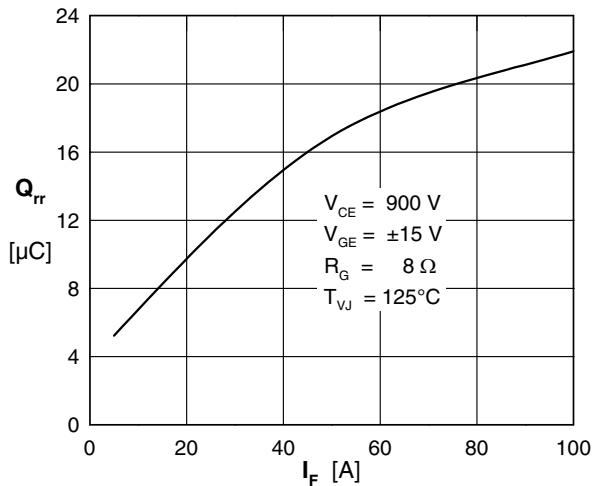

Fig. 15 Typical turn-off characteristics of free wheeling diode

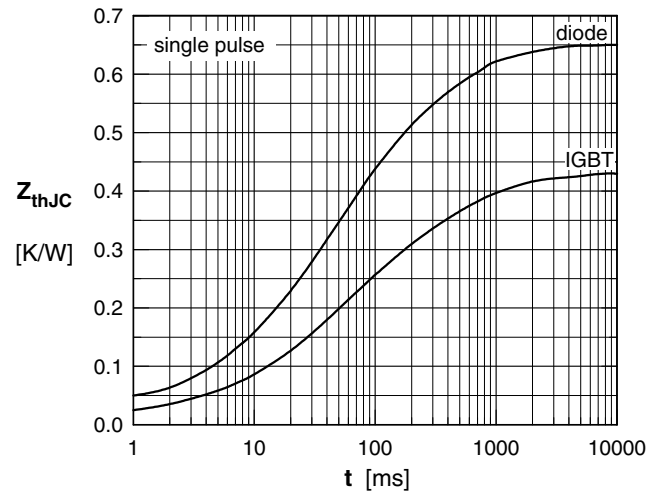

Fig. 16 Transient thermal impedance junction to case

Temperature Sensor NTC

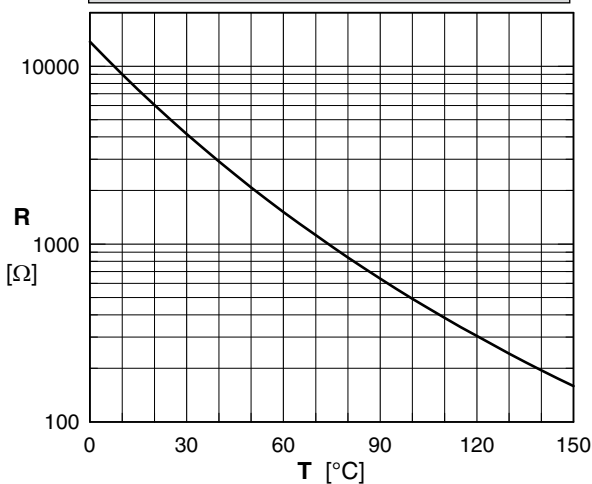
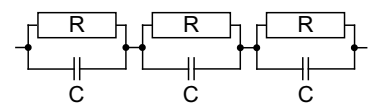

Fig. 17 Typ. NTC resistance vs. temperature

| | IGBT | | Diode | |
|---|----------------|----------------|----------------|----------------|
| | R _i | τ _i | R _i | τ _i |
| 1 | 0.0326 | 0.0014 | 0.1941 | 0.0206 |
| 2 | 0.1311 | 0.0258 | 0.0542 | 0.0016 |
| 3 | 0.1492 | 0.1099 | 0.2549 | 0.0930 |
| 4 | 0.1169 | 0.6361 | 0.1461 | 0.5958 |



Brake Chopper T7 / D7

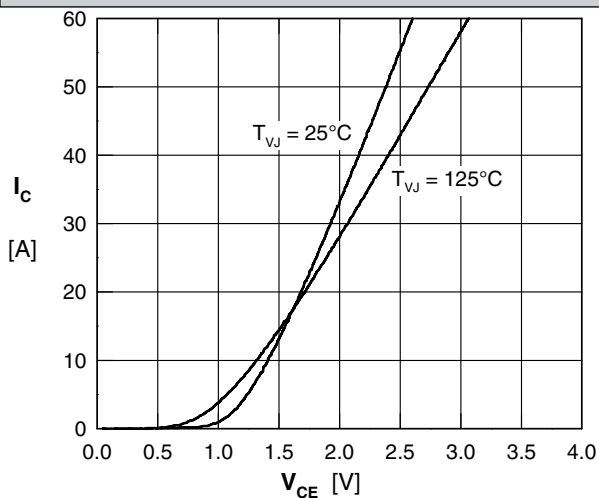

Fig. 18 Typical output characteristic

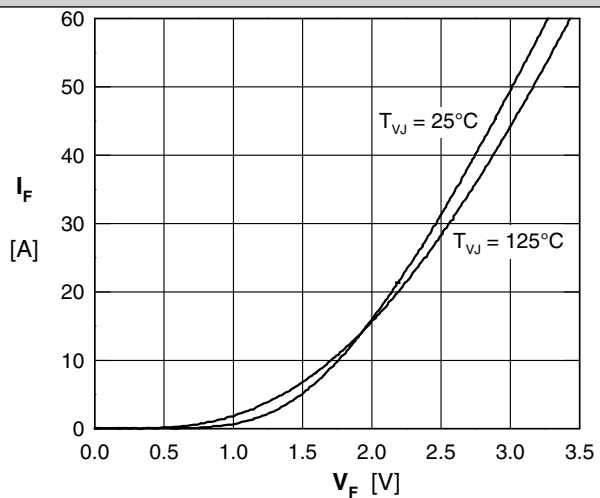

Fig. 19 Typ. forward characteristics of brake diode

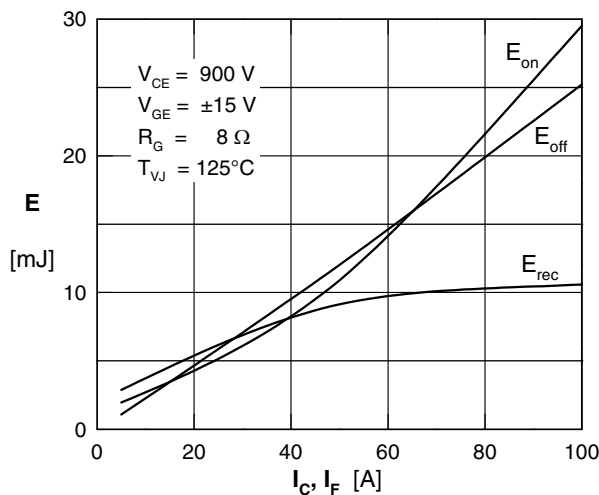

Fig. 20 Typ. turn on energy & switching times versus collector current

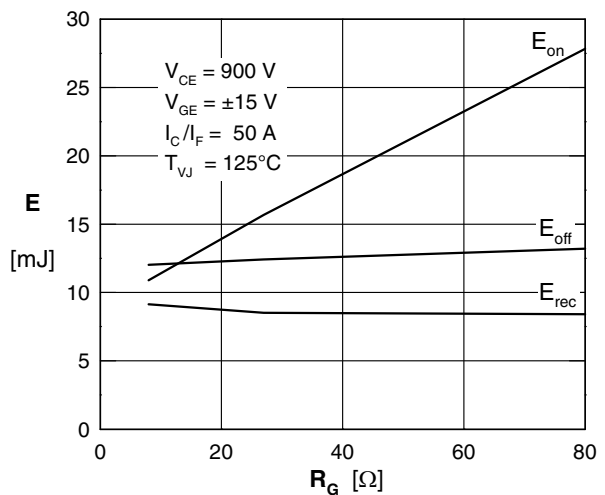

Fig. 21 Typ. turn off energy and switching times versus collector current

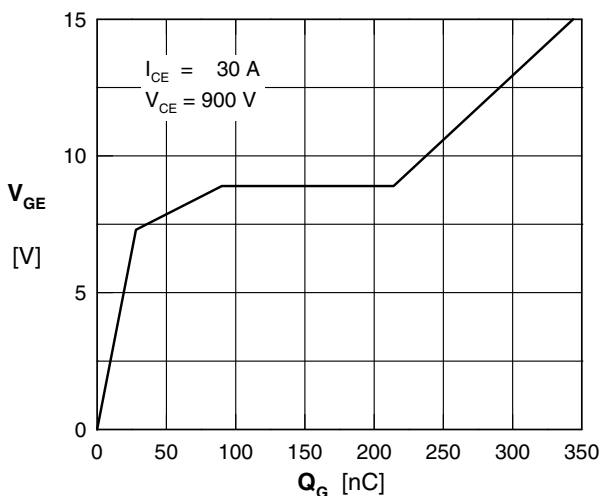

Fig. 22 Typ. turn on gate charge

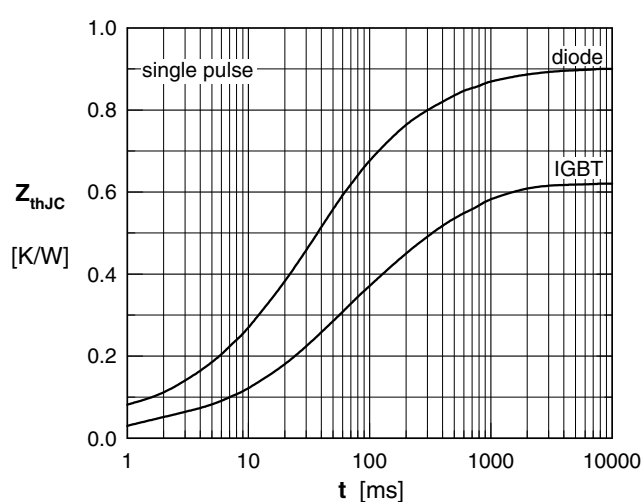

Fig. 23 Transient thermal impedance junction to case

IXYS reserves the right to change limits, test conditions and dimensions.

20090826a