

# XPT IGBT Module

 $V_{CES} = 1200\text{ V}$ 
 $I_{C25} = 335\text{ A}$ 
 $V_{CE(sat)} = 1.7\text{ V}$ 

Boost/Brake Chopper + free wheeling Diode + NTC

Part number

**MIXG240RF1200PTED**

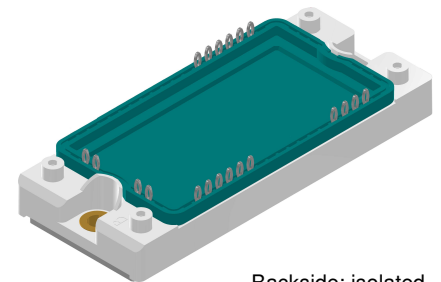

Backside: isolated

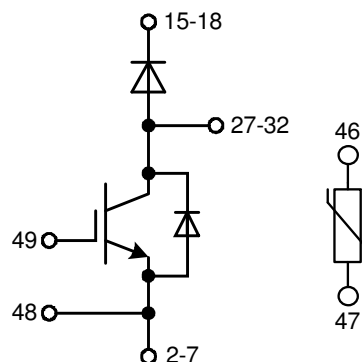

### Features / Advantages:

- X2PT - 2nd generation Xtreme light Punch Through
- Rugged X2PT design results in:
  - short circuit rated for 10  $\mu\text{sec}$ .
  - very low gate charge
  - low EMI
  - square RBSOA @ 2x  $I_c$
- Thin wafer technology combined with X2PT design results in a competitive low  $V_{CE(sat)}$
- Easy paralleling due to the positive temperature coefficient of the on-state voltage
- SONIC™ diode
  - fast and soft reverse recovery
  - low operating forward voltage

### Applications:

- AC motor drives
- Solar inverter
- Medical equipment
- Uninterruptible power supply
- Air-conditioning systems
- Welding equipment
- Switched-mode and resonant-mode power supplies
- Inductive heating, cookers
- Pumps, Fans

### Package: E2-Pack

- Isolation Voltage: 3600 V~
- Industry standard outline
- RoHS compliant
- PressFit-Pins for PCB mounting
- Height: 17 mm
- Base plate: Copper internally DCB isolated
- Advanced power cycling
- Phase Change Material available

### Terms and Conditions of Usage

The data contained in this product data sheet is exclusively intended for technically trained staff. The user will have to evaluate the suitability of the product for the intended application and the completeness of the product data with respect to his application. The specifications of our components may not be considered as an assurance of component characteristics. The information in the valid application- and assembly notes must be considered. Should you require product information in excess of the data given in this product data sheet or which concerns the specific application of your product, please contact your local sales office.

Due to technical requirements our product may contain dangerous substances. For information on the types in question please contact your local sales office.

Should you intend to use the product in aviation, in health or life endangering or life support applications, please notify. For any such application we urgently recommend

- to perform joint risk and quality assessments;

- the conclusion of quality agreements;

- to establish joint measures of an ongoing product survey, and that we may make delivery dependent on the realization of any such measures.

Free Wheeling Diode FWD				Ratings			
Symbol	Definition	Conditions	min.	typ.	max.	Unit	
$V_{RSM}$	max. non-repetitive reverse blocking voltage	$T_{VJ} = 25^{\circ}C$			1200	V	
$V_{RRM}$	max. repetitive reverse blocking voltage	$T_{VJ} = 25^{\circ}C$			1200	V	
$I_R$	reverse current, drain current	$V_R = 1200 V$			*	$\mu A$	
	* not applicable, see Ices at IGBT	$V_R = 1200 V$			*	mA	
$V_F$	forward voltage drop	$I_F = 20 A$			2.20	V	
		$I_F = 40 A$			2.82	V	
		$I_F = 20 A$	$T_{VJ} = 150^{\circ}C$			1.90	V
		$I_F = 40 A$	$T_{VJ} = 150^{\circ}C$			3.08	V
$I_{FAV}$	average forward current	$T_C = 80^{\circ}C$ rectangular $d = 0.5$			30	A	
$V_{FO}$	threshold voltage	} for power loss calculation only			1.20	V	
$r_F$	slope resistance				45	m $\Omega$	
$R_{thJC}$	thermal resistance junction to case				1.3	K/W	
$R_{thCH}$	thermal resistance case to heatsink			0.50		K/W	
$P_{tot}$	total power dissipation	$T_C = 25^{\circ}C$			115	W	
$I_{FSM}$	max. forward surge current	$t = 10 ms; (50 Hz), sine; V_R = 0 V$			120	A	
$C_J$	junction capacitance	$V_R = 600 V$ $f = 1 MHz$			7	pF	

Boost IGBT				Ratings			
Symbol	Definition	Conditions	min.	typ.	max.	Unit	
$V_{CES}$	collector emitter voltage				1200	V	
$V_{GES}$	max. DC gate voltage				±20	V	
$V_{GEM}$	max. transient gate emitter voltage				±30	V	
$I_{C25}$	collector current				335	A	
$I_{C80}$					250	A	
$P_{tot}$	total power dissipation				1250	W	
$V_{CE(sat)}$	collector emitter saturation voltage	$I_C = 200A; V_{GE} = 15V$			1.7	V	
					2	V	
$V_{GE(th)}$	gate emitter threshold voltage	$I_C = 8mA; V_{GE} = V_{CE}$	6	6.8	7.5	V	
$I_{CES}$	collector emitter leakage current	$V_{CE} = V_{CES}; V_{GE} = 0V$			0.2	mA	
					2	mA	
$I_{GES}$	gate emitter leakage current	$V_{GE} = ±20V$			500	nA	
$Q_{G(on)}$	total gate charge	$V_{CE} = 600V; V_{GE} = 15V; I_C = 200A$		930		nC	
$t_{d(on)}$	turn-on delay time	inductive load $V_{CE} = 600V; I_C = 200A$ $V_{GE} = ±15V; R_G = 3.3Ω$		220		ns	
$t_r$	current rise time			75		ns	
$t_{d(off)}$	turn-off delay time			400		ns	
$t_f$	current fall time			240		ns	
$E_{on}$	turn-on energy per pulse			25		mJ	
$E_{off}$	turn-off energy per pulse			22.5		mJ	
<b>RBSOA</b>	reverse bias safe operating area	$V_{GE} = ±15V; R_G = 3.3Ω$					
$I_{CM}$		$V_{CEmax} = 1200V$			600	A	
<b>SCSOA</b>	short circuit safe operating area	$V_{CEmax} = 1200V$					
$t_{SC}$	short circuit duration	$V_{CE} = 720V; V_{GE} = ±15V$			10	μs	
$I_{SC}$	short circuit current	$R_G = 3.3Ω; \text{non-repetitive}$		900		A	
$R_{thJC}$	thermal resistance junction to case				0.12	K/W	
$R_{thCH}$	thermal resistance case to heatsink				0.06	K/W	
<b>Boost Diode BD</b>							
$V_{RRM}$	max. repetitive reverse voltage				1200	V	
$I_{F25}$	forward current				265	A	
$I_{F80}$					195	A	
$V_F$	forward voltage	$I_F = 200A$			2.20	V	
					1.90	V	
$I_R$	reverse current	$V_R = V_{RRM}$			0.4	mA	
					4	mA	
$Q_{rr}$	reverse recovery charge	$V_R = 600V$ $-di_F/dt = 3200A/μs$ $I_F = 200A; V_{GE} = 0V$		71		μC	
$I_{RM}$	max. reverse recovery current			190		A	
$t_{rr}$	reverse recovery time			450		ns	
$E_{rec}$	reverse recovery energy			11		mJ	
$R_{thJC}$	thermal resistance junction to case				0.2	K/W	
$R_{thCH}$	thermal resistance case to heatsink				0.10	K/W	

Package E2-Pack		Ratings				
Symbol	Definition	Conditions	min.	typ.	max.	Unit
$I_{RMS}$	RMS current	per terminal			30	A
$T_{VJ}$	virtual junction temperature		-40		175	°C
$T_{op}$	operation temperature		-40		150	°C
$T_{stg}$	storage temperature		-40		125	°C
<b>Weight</b>				176		g
$M_D$	mounting torque		3		6	Nm
$d_{Spp/App}$	creepage distance on surface / striking distance through air	terminal to terminal	6.0			mm
$d_{Spb/Apb}$		terminal to backside	12.0			mm
$V_{ISOL}$	isolation voltage	t = 1 second t = 1 minute 50/60 Hz, RMS; $I_{ISOL} \leq 1$ mA	3600			V
			3000			V
$R_{pin-chip}$	resistance pin to chip	$V = V_{CEsat} + 2 \cdot R \cdot I_C$ resp. $V = V_F + 2 \cdot R \cdot I_F$		2.5		mΩ

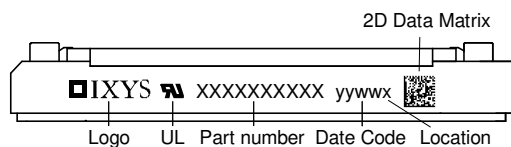
**Part description**

- M = Module
- I = IGBT
- X = XPT IGBT
- G = Gen 2 / std
- 240 = Current Rating [A]
- RF = Boost/Brake Chopper + free wheeling Diode
- 1200 = Reverse Voltage [V]
- PT = PressFit-Pin, Thermistor
- ED = E2-Pack

Ordering	Ordering Number	Marking on Product	Delivery Mode	Quantity	Code No.
Standard	MIXG240RF1200PTED	MIXG240RF1200PTED	Blister	28	522223
Alternative	MIXG240RF1200PTED-PC	MIXG240RF1200PTED	Blister	28	522145

Similar Part	Package	Voltage class
MIXG360RF1200PTED	E2-Pack	1200

**Temperature Sensor NTC**

Symbol	Definition	Conditions	min.	typ.	max.	Unit
$R_{25}$	resistance	$T_{VJ} = 25^\circ$	4.85	5	5.15	kΩ
$B_{25/50}$	temperature coefficient			3375		K

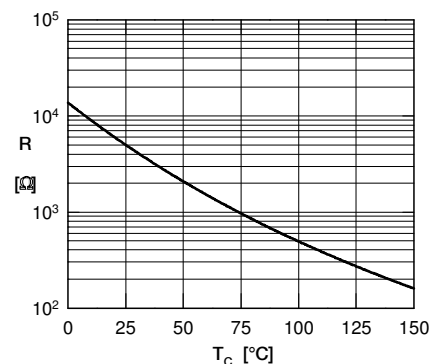

## Outlines E2-Pack

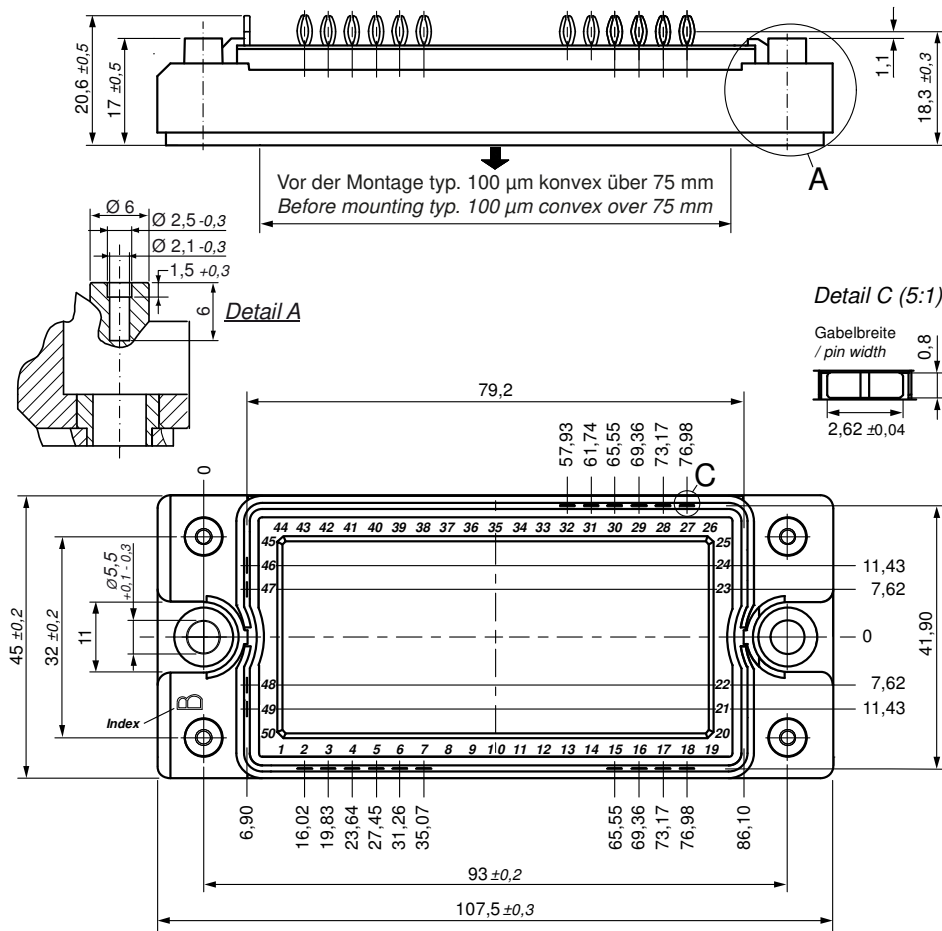

### Bemerkung / Note:

- Nicht tolerierte Maße nach / Measure without tolerances according DIN ISO 2768-T1-m
- PCB-Lochmuster / PCB hole pattern: **see pin position**
- Toleranz Pin-Position und PCB-Lochmuster / Tolerance of pin position and PCB hole pattern:  $\oplus 0.1$
- Bohrlochdurchmesser / Diameter of drill: **Ø 2.35 mm**
- Endlochdurchmesser / Diameter of plated holes: **Ø 2.14 - 2.29 mm** (Cu thickness in via typ. 50 µm)
- Beschichtung / Plating: **chem. Sn max. 15 µm**
- Einpresskraft / Insert Force: per terminal with a typ. insert speed of 7 mm/s: **typ. 90 N**
- Weitere Angaben / Further information: [www.ixys.com](http://www.ixys.com) **Application note IXAN0077**
- Montageanleitung / Mounting instruction: [www.ixys.com](http://www.ixys.com) **Application note IXAN0024**

### Detail A: PCB-Montage / Mounting on PCB<sup>L</sup>

- Empfohlene, selbstschneidende Schraube / Recommended, self-tapping screw: **EJOT PT®** (Größe / size: **K25**)<sup>L</sup>
- Max. Schraubenlänge / Max. screw length: **PCB-Dicke / thickness + 6 mm** (max. Lochtiefe / hole depth)<sup>L</sup>
- Empfohlenes Drehmoment / Recommended mounting torque: **1.5 Nm**

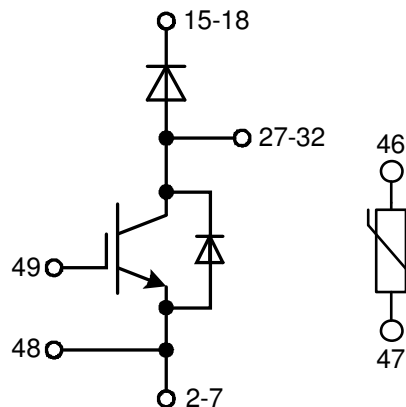

## Boost IGBT

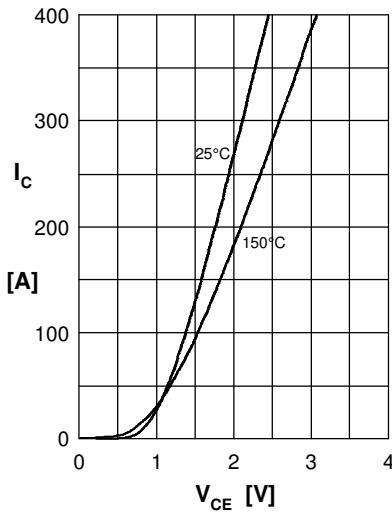

Fig. 1 Typ. output characteristics IGBT

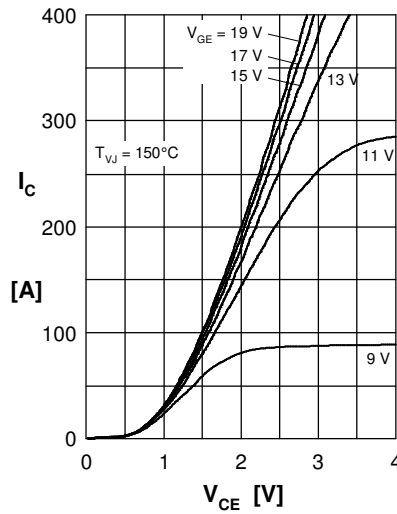

Fig. 2 Typ. output characteristics IGBT

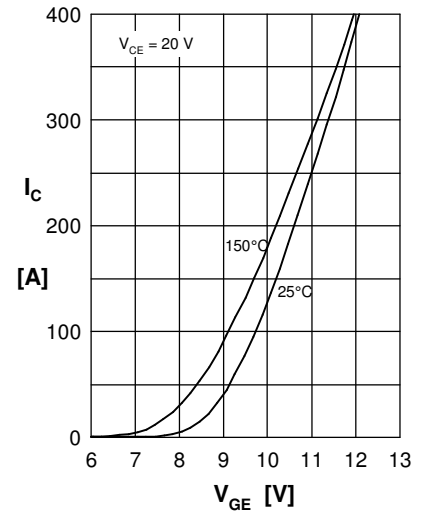

Fig. 3 Typ. transfer char. IGBT

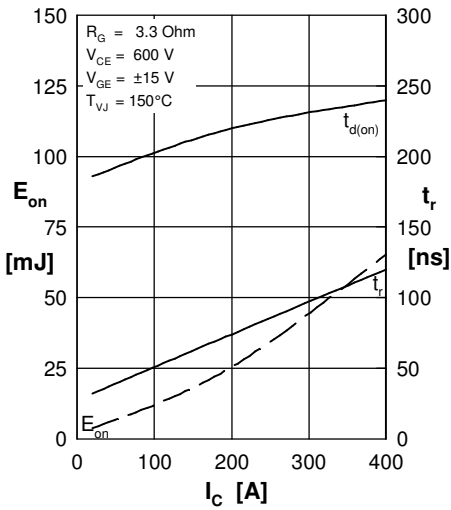

Fig. 4 Typ. turn-on energy & switch. times vs. collector current

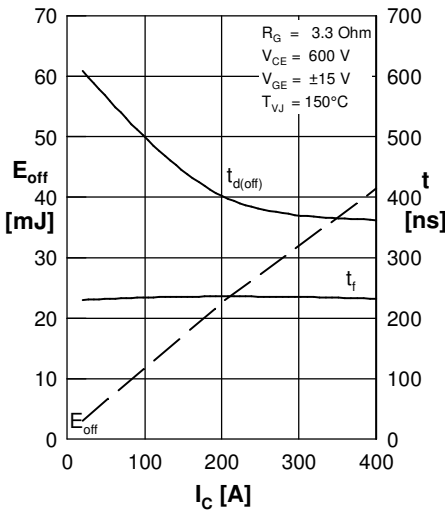

Fig. 5 Typ. turn-off energy & switch. times vs. collector current

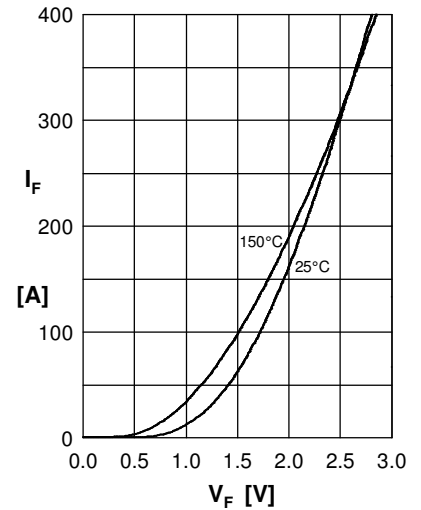

Fig. 6 Typ. forward characteristics Diode

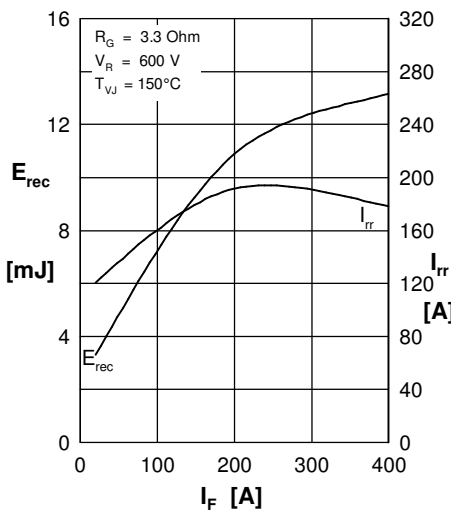

Fig. 7 Typ. reverse recovery characteristics Diode

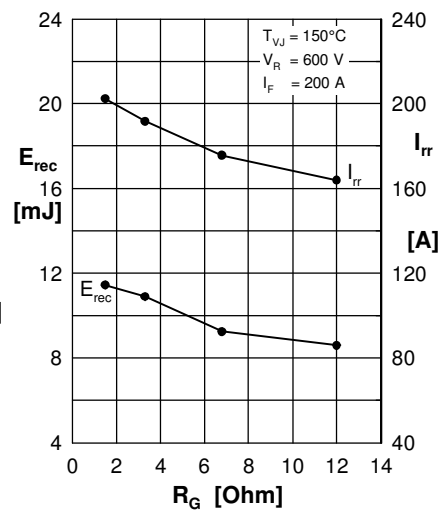

Fig. 8 Typ. reverse recovery characteristics Diode

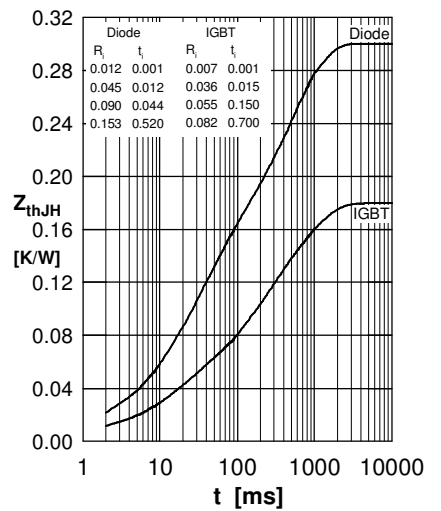

Fig. 9 Typ. transient thermal resistance junction to heatsink