

# Converter - Brake - Inverter Module

## XPT IGBT

Three Phase Rectifier	Brake Chopper	Three Phase Inverter
$V_{RRM} = 1600 \text{ V}$	$V_{CES} = 1200 \text{ V}$	$V_{CES} = 1200 \text{ V}$
$I_{DAVM} = 265 \text{ A}$	$I_{C25} = 60 \text{ A}$	$I_{C25} = 120 \text{ A}$
$I_{FSM} = 1100 \text{ A}$	$V_{CE(sat)} = 1.8 \text{ V}$	$V_{CE(sat)} = 1.8 \text{ V}$

**Part name** (Marking on product)

MIXA80WB1200TEH

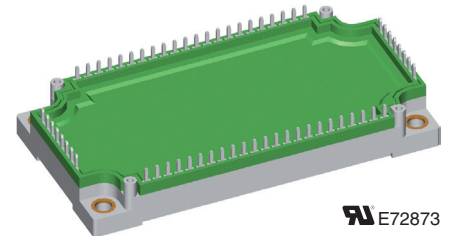

E72873

Pin configuration see outlines.

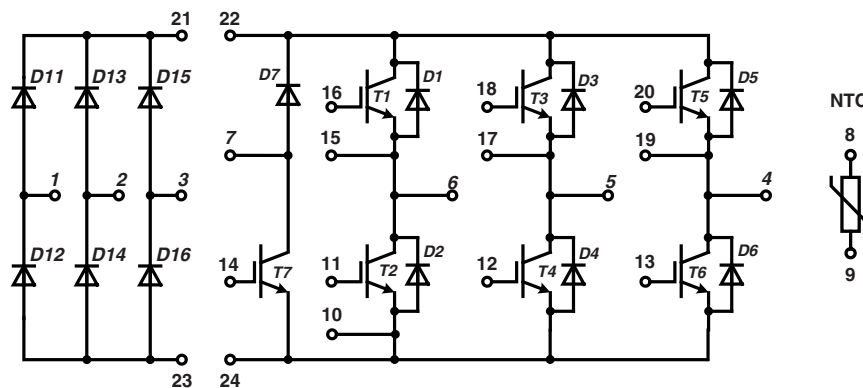

### Features:

- Easy paralleling due to the positive temperature coefficient of the on-state voltage
- Rugged XPT design (Xtreme light Punch Through) results in:
  - short circuit rated for 10  $\mu\text{sec}$ .
  - very low gate charge
  - square RBSOA @ 3x  $I_C$
  - low EMI
- Thin wafer technology combined with the XPT design results in a competitive low  $V_{CE(sat)}$
- SONIC™ diode
  - fast and soft reverse recovery
  - low operating forward voltage

### Application:

- AC motor drives
- Solar inverter
- Medical equipment
- Uninterruptible power supply
- Air-conditioning systems
- Welding equipment
- Switched-mode and resonant-mode power supplies

### Package:

- "E3-Pack" standard outline
- Insulated copper base plate
- Soldering pins for PCB mounting
- Temperature sense included

### Terms & Conditions of usage

The data contained in this product data sheet is exclusively intended for technically trained staff. The user will have to evaluate the suitability of the product for the intended application and the completeness of the product data with respect to his application. The specifications of our components may not be considered as an assurance of component characteristics. The information in the valid application- and assembly notes must be considered. Should you require product information in excess of the data given in this product data sheet or which concerns the specific application of your product, please contact the sales office, which is responsible for you. Due to technical requirements our product may contain dangerous substances. For information on the types in question please contact the sales office, which is responsible for you. Should you intend to use the product in aviation, in health or life endangering or life support applications, please notify. For any such application we urgently recommend

- to perform joint risk and quality assessments;
- the conclusion of quality agreements;
- to establish joint measures of an ongoing product survey, and that we may make delivery dependent on the realization of any such measures.

IXYS reserves the right to change limits, test conditions and dimensions.

20160518e

**Output Inverter T1 - T6**

Symbol	Definitions	Conditions	Ratings			Unit	
			min.	typ.	max.		
$V_{CES}$	collector emitter voltage		$T_{VJ} = 25^{\circ}\text{C}$		1200	V	
$V_{GES}$	max. DC gate voltage	continuous			$\pm 20$	V	
$V_{GEM}$	max. transient collector gate voltage	transient			$\pm 30$	V	
$I_{C25}$	collector current		$T_C = 25^{\circ}\text{C}$		120	A	
$I_{C80}$			$T_C = 80^{\circ}\text{C}$		84	A	
$P_{tot}$	total power dissipation		$T_C = 25^{\circ}\text{C}$		390	W	
$V_{CE(sat)}$	collector emitter saturation voltage	$I_C = 77\text{ A}; V_{GE} = 15\text{ V}$	$T_{VJ} = 25^{\circ}\text{C}$ $T_{VJ} = 125^{\circ}\text{C}$	1.8 2.1	2.1	V V	
$V_{GE(th)}$	gate emitter threshold voltage	$I_C = 3\text{ mA}; V_{GE} = V_{CE}$	$T_{VJ} = 25^{\circ}\text{C}$	5.4	6.0	6.5	V
$I_{CES}$	collector emitter leakage current	$V_{CE} = V_{CES}; V_{GE} = 0\text{ V}$	$T_{VJ} = 25^{\circ}\text{C}$ $T_{VJ} = 125^{\circ}\text{C}$		0.03 0.6	0.2	mA mA
$I_{GES}$	gate emitter leakage current	$V_{GE} = \pm 20\text{ V}$			500	nA	
$Q_{G(on)}$	total gate charge	$V_{CE} = 600\text{ V}; V_{GE} = 15\text{ V}; I_C = 75\text{ A}$			230	nC	
$t_{d(on)}$	turn-on delay time	inductive load $V_{CE} = 600\text{ V}; I_C = 75\text{ A}$ $V_{GE} = \pm 15\text{ V}; R_G = 10\ \Omega$	$T_{VJ} = 125^{\circ}\text{C}$		70	ns	
$t_r$	current rise time				40	ns	
$t_{d(off)}$	turn-off delay time				250	ns	
$t_f$	current fall time				100	ns	
$E_{on}$	turn-on energy per pulse				6.8	mJ	
$E_{off}$	turn-off energy per pulse				8.3	mJ	
<b>RBSOA</b>	reverse bias safe operating area	$V_{GE} = \pm 15\text{ V}; R_G = 10\ \Omega;$	$T_{VJ} = 125^{\circ}\text{C}$ $V_{CEK} = 1200\text{ V}$		225	A	
<b>SCSOA</b>	short circuit safe operating area		$T_{VJ} = 125^{\circ}\text{C}$		10	$\mu\text{s}$	
$t_{SC}$	short circuit duration	$V_{CE} = 900\text{ V}; V_{GE} = \pm 15\text{ V};$			300	A	
$I_{SC}$	short circuit current	$R_G = 10\ \Omega;$ non-repetitive					
$R_{thJC}$	thermal resistance junction to case	(per IGBT)			0.32	K/W	

**Output Inverter D1 - D6**

Symbol	Definitions	Conditions	Ratings			Unit
			min.	typ.	max.	
$V_{RRM}$	max. repetitive reverse voltage		$T_{VJ} = 25^{\circ}\text{C}$		1200	V
$I_{F25}$	forward current		$T_C = 25^{\circ}\text{C}$		135	A
$I_{F80}$			$T_C = 80^{\circ}\text{C}$		90	A
$V_F$	forward voltage	$I_F = 100\text{ A}; V_{GE} = 0\text{ V}$	$T_{VJ} = 25^{\circ}\text{C}$ $T_{VJ} = 125^{\circ}\text{C}$	1.95 1.95	2.2	V V
$Q_{rr}$	reverse recovery charge	$V_R = 600\text{ V}$ $di_F/dt = -1600\text{ A}/\mu\text{s}$ $I_F = 100\text{ A}; V_{GE} = 0\text{ V}$	$T_{VJ} = 125^{\circ}\text{C}$		12.5	$\mu\text{C}$
$I_{RM}$	max. reverse recovery current				100	A
$t_{rr}$	reverse recovery time				350	ns
$E_{rec}$	reverse recovery energy				4	mJ
$R_{thJC}$	thermal resistance junction to case	(per diode)			0.4	K/W

 $T_C = 25^{\circ}\text{C}$  unless otherwise stated

**Brake T7**

Symbol	Definitions	Conditions	Ratings			Unit	
			min.	typ.	max.		
$V_{CES}$	collector emitter voltage		$T_{VJ} = 25^{\circ}\text{C}$		1200	V	
$V_{GES}$	max. DC gate voltage	continuous			$\pm 20$	V	
$V_{GEM}$	max. transient collector gate voltage	transient			$\pm 30$	V	
$I_{C25}$	collector current		$T_C = 25^{\circ}\text{C}$		60	A	
$I_{C80}$			$T_C = 80^{\circ}\text{C}$		40	A	
$P_{tot}$	total power dissipation		$T_C = 25^{\circ}\text{C}$		195	W	
$V_{CE(sat)}$	collector emitter saturation voltage	$I_C = 35\text{ A}; V_{GE} = 15\text{ V}$	$T_{VJ} = 25^{\circ}\text{C}$ $T_{VJ} = 125^{\circ}\text{C}$	1.8 2.1	2.1	V V	
$V_{GE(th)}$	gate emitter threshold voltage	$I_C = 1.5\text{ mA}; V_{GE} = V_{CE}$	$T_{VJ} = 25^{\circ}\text{C}$	5.4	6.0	6.5	V
$I_{CES}$	collector emitter leakage current	$V_{CE} = V_{CES}; V_{GE} = 0\text{ V}$	$T_{VJ} = 25^{\circ}\text{C}$ $T_{VJ} = 125^{\circ}\text{C}$	0.01 0.1	0.1	mA mA	
$I_{GES}$	gate emitter leakage current	$V_{GE} = \pm 20\text{ V}$			500	nA	
$Q_{G(on)}$	total gate charge	$V_{CE} = 600\text{ V}; V_{GE} = 15\text{ V}; I_C = 35\text{ A}$			107	nC	
$t_{d(on)}$	turn-on delay time	inductive load $V_{CE} = 600\text{ V}; I_C = 35\text{ A}$ $V_{GE} = \pm 15\text{ V}; R_G = 27\ \Omega$	$T_{VJ} = 125^{\circ}\text{C}$	70		ns	
$t_r$	current rise time			40		ns	
$t_{d(off)}$	turn-off delay time			250		ns	
$t_f$	current fall time			100		ns	
$E_{on}$	turn-on energy per pulse			3.8		mJ	
$E_{off}$	turn-off energy per pulse			4.1		mJ	
<b>RBSOA</b>	reverse bias safe operating area	$V_{GE} = \pm 15\text{ V}; R_G = 27\ \Omega;$	$T_{VJ} = 125^{\circ}\text{C}$ $V_{CEK} = 1200\text{ V}$		105	A	
<b>SCSOA</b>	short circuit safe operating area		$T_{VJ} = 125^{\circ}\text{C}$		10	$\mu\text{s}$	
$t_{SC}$	short circuit duration	$V_{CE} = 900\text{ V}; V_{GE} = \pm 15\text{ V};$			140	A	
$I_{SC}$	short circuit current	$R_G = 27\ \Omega;$ non-repetitive					
$R_{thJC}$	thermal resistance junction to case				0.64	K/W	

**Brake Chopper D7**

Symbol	Definitions	Conditions	Ratings			Unit
			min.	typ.	max.	
$V_{RRM}$	max. repetitive reverse voltage		$T_{VJ} = 25^{\circ}\text{C}$		1200	V
$I_{F25}$	forward current		$T_C = 25^{\circ}\text{C}$		44	A
$I_{F80}$			$T_C = 80^{\circ}\text{C}$		29	A
$V_F$	forward voltage	$I_F = 30\text{ A}; V_{GE} = 0\text{ V}$	$T_{VJ} = 25^{\circ}\text{C}$ $T_{VJ} = 125^{\circ}\text{C}$	1.95 1.95	2.2	V V
$I_R$	reverse current	$V_R = V_{RRM}$	$T_{VJ} = 25^{\circ}\text{C}$ $T_{VJ} = 125^{\circ}\text{C}$	0.01 0.15	0.1	mA mA
$Q_{rr}$	reverse recovery charge	$V_R = 600\text{ V}$ $di_F/dt = 600\text{ A}/\mu\text{s}$ $I_F = 30\text{ A}; V_{GE} = 0\text{ V}$	$T_{VJ} = 125^{\circ}\text{C}$	3.5		$\mu\text{C}$
$I_{RM}$	max. reverse recovery current			30		A
$t_{rr}$	reverse recovery time			350		ns
$E_{rec}$	reverse recovery energy			0.9		mJ
$R_{thJC}$	thermal resistance junction to case				1.2	K/W

 $T_C = 25^{\circ}\text{C}$  unless otherwise stated

**Input Rectifier Bridge D11 - D16**

Symbol	Definitions	Conditions	Ratings			Unit
			min.	typ.	max.	
$V_{RRM}$	max. repetitive reverse voltage				1600	V
$I_{FAV}$	average forward current	sine 180°			94	A
$I_{DAVM}$	max. average DC output current	rect.; $d = 1/3$			265	A
$I_{FSM}$	max. forward surge current	$t = 10$ ms; sine 50 Hz			1100	A
$I^2t$	$I^2t$ value for fusing	$t = 10$ ms; sine 50 Hz			6000	A <sup>2</sup> s
$P_{tot}$	total power dissipation				4700	A <sup>2</sup> s
$V_F$	forward voltage	$I_F = 150$ A		1.3	1.6	V
$I_R$	reverse current	$V_R = V_{RRM}$		1.3		V
$R_{thJC}$	thermal resistance junction to case	(per diode)		0.05	0.1	mA
				2.0		mA
					0.5	K/W

**Temperature Sensor NTC**

Symbol	Definitions	Conditions	Ratings			Unit	
			min.	typ.	max.		
$R_{25}$	resistance						
$B_{25/50}$							
			$T_C = 25^\circ\text{C}$	4.75	5.0	5.25	k $\Omega$
					3375	K	

**Module**

Symbol	Definitions	Conditions	Ratings			Unit
			min.	typ.	max.	
$T_{VJ}$	operating temperature		-40		125	°C
$T_{VJM}$	max. virtual junction temperature				150	°C
$T_{stg}$	storage temperature		-40		125	°C
$V_{ISOL}$	isolation voltage	$I_{ISOL} \leq 1$ mA; 50/60 Hz			3000	V~
CTI	comparative tracking index				200	
$M_d$	mounting torque (M5)		3		6	Nm
$d_S$	creep distance on surface		6			mm
$d_A$	strike distance through air		6			mm
$R_{pin-chip}$	resistance pin to chip			5		m $\Omega$
$R_{thCH}$	thermal resistance case to heatsink	with heatsink compound		0.01		K/W
Weight				300		g

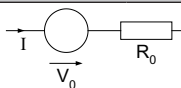
**Equivalent Circuits for Simulation**

Symbol	Definitions	Conditions	Ratings			Unit
			min.	typ.	max.	
$V_0$	rectifier diode	D8 - D13			0.87	V
$R_0$					2.7	m $\Omega$
$V_0$	IGBT	T1 - T6			1.1	V
$R_0$					17.9	m $\Omega$
$V_0$	free wheeling diode	D1 - D6			1.09	V
$R_0$					9.1	m $\Omega$
$V_0$	IGBT	T7			1.1	V
$R_0$					40	m $\Omega$
$V_0$	free wheeling diode	D7			1.2	V
$R_0$					27.0	m $\Omega$

 $T_C = 25^\circ\text{C}$  unless otherwise stated

### Circuit Diagram

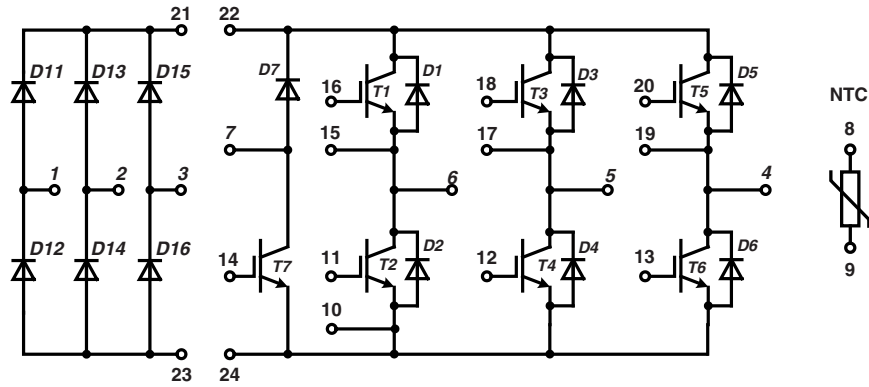

### Outline Drawing

Dimensions in mm (1 mm = 0.0394")

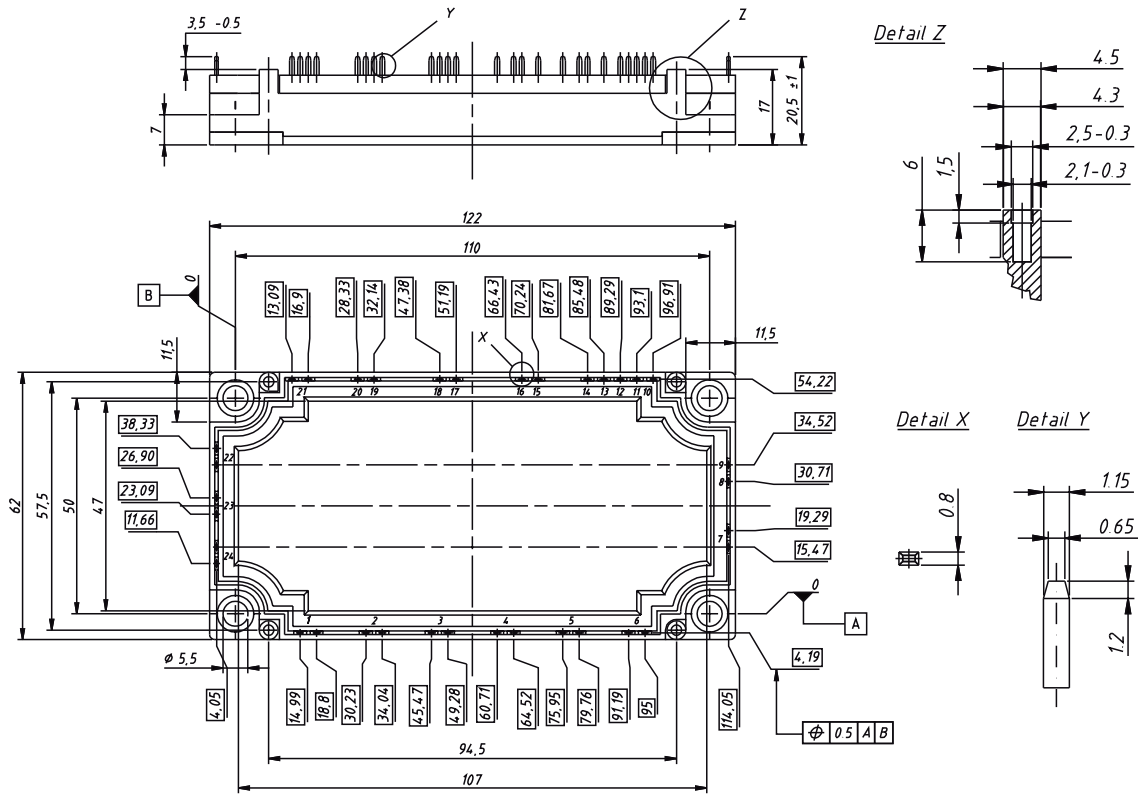

### Product Marking

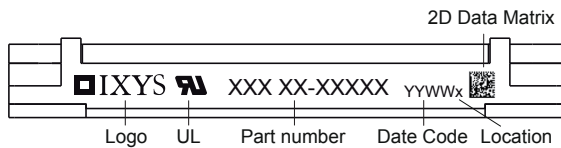

#### Part number

- M = Module
- I = IGBT
- XA = XPT standard
- 80 = Current Rating [A]
- WB = 6-Pack + 3~ Rectifier Bridge & Brake Unit
- 1200 = Reverse Voltage [V]
- T = NTC
- EH = E3-Pack

Ordering	Part Name	Marking on Product	Delivering Mode	Base Qty	Ordering Code
Standard	MIXA80WB1200 TEH	MIXA80WB1200TEH	Box	5	509112

## Inverter T1 - T6

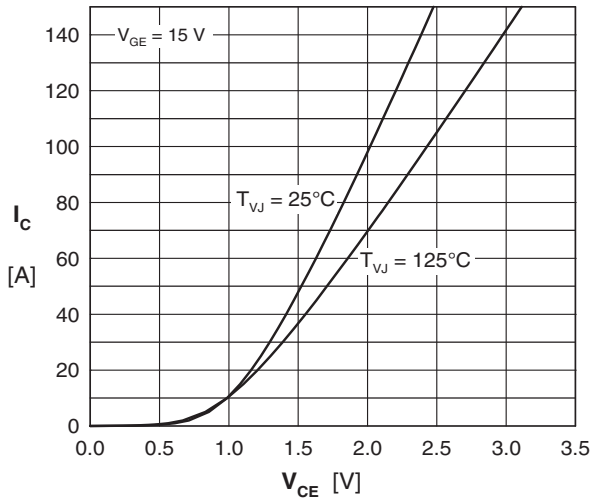

Fig. 1 Typ. output characteristics

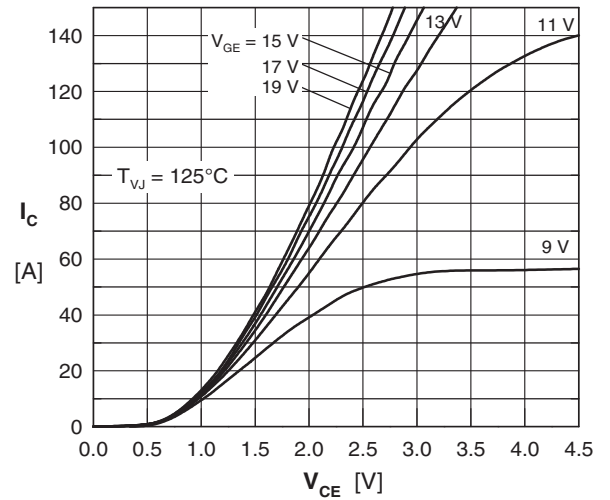

Fig. 2 Typ. output characteristics

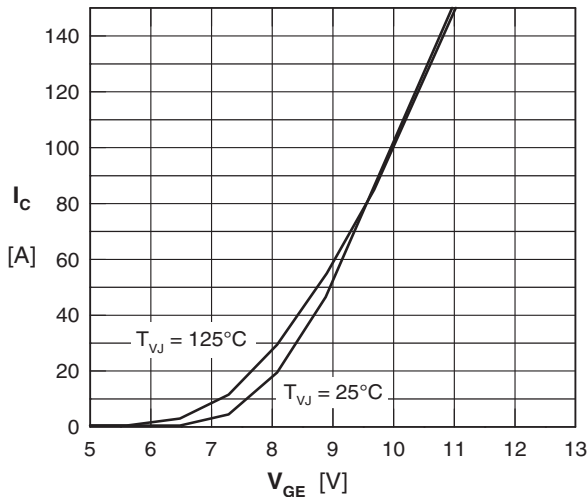

Fig. 3 Typ. transfer characteristics

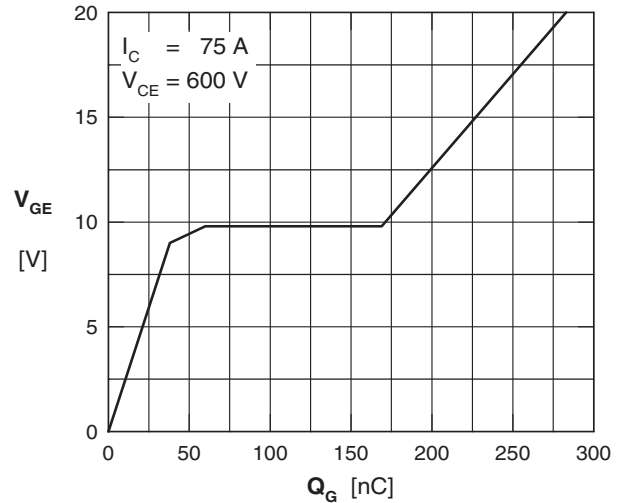

Fig. 4 Typ. turn-on gate charge

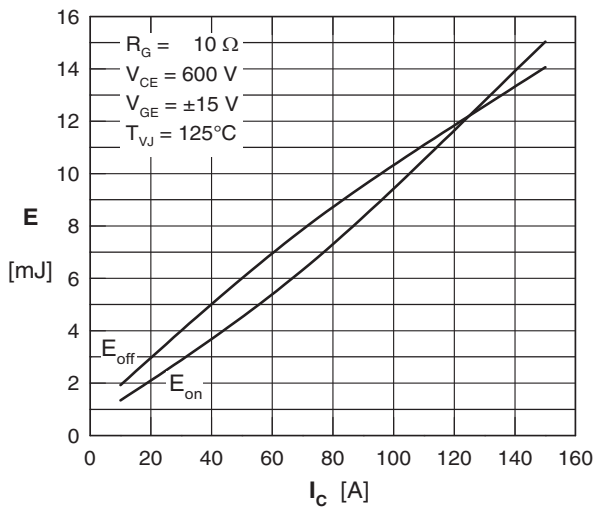

Fig. 5 Typ. switching energy vs. collector current

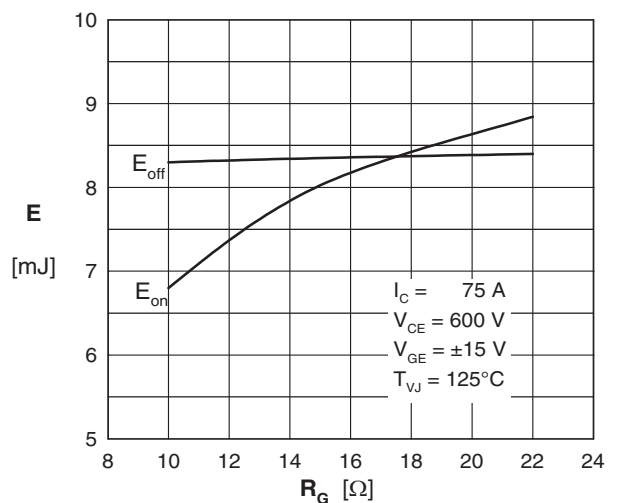

Fig. 6 Typ. switching energy vs. gate resistance

## Inverter D1 - D6

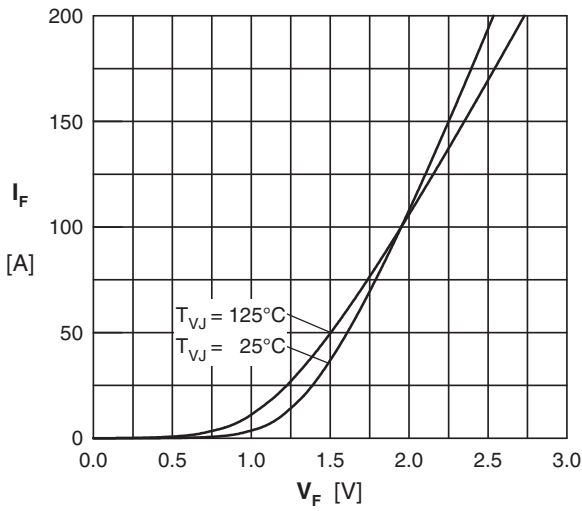

Fig. 7 Typ. Forward current versus  $V_F$

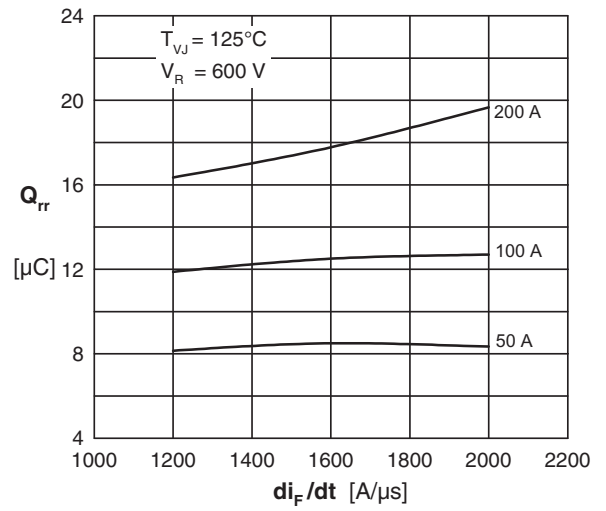

Fig. 8 Typ. reverse recov.charge  $Q_{rr}$  vs.  $di/dt$

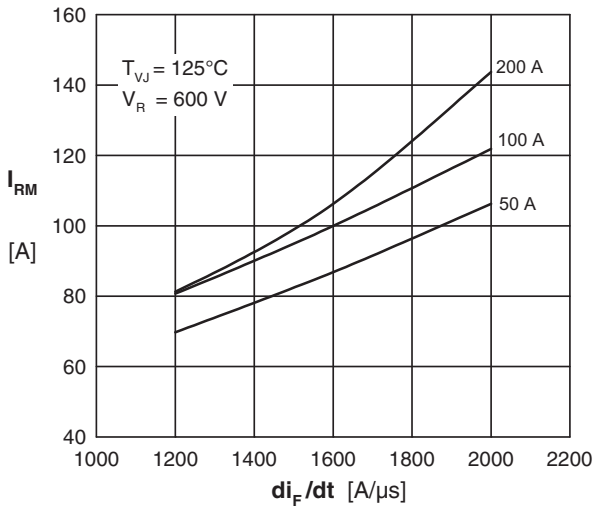

Fig. 9 Typ. peak reverse current  $I_{RM}$  vs.  $di/dt$

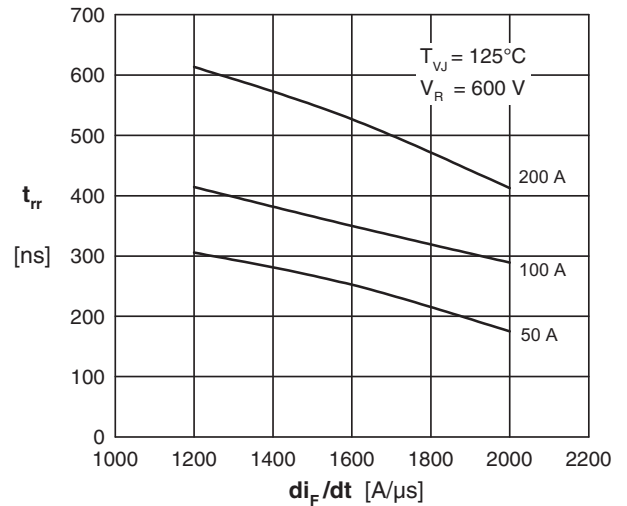

Fig. 10 Typ. recovery time  $t_{rr}$  versus  $di/dt$

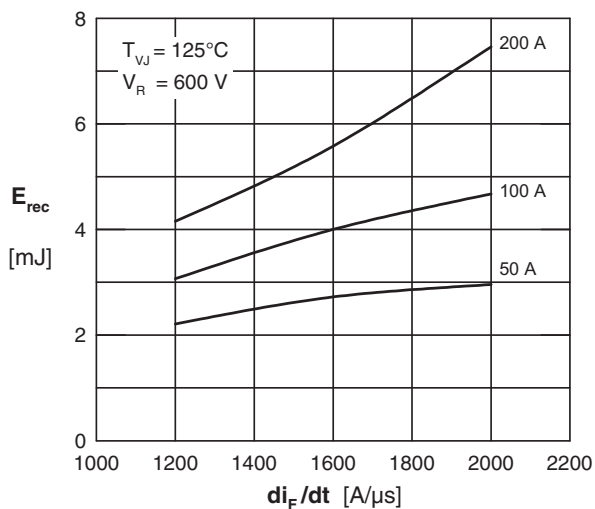

Fig. 11 Typ. recovery energy  $E_{rec}$  versus  $di/dt$

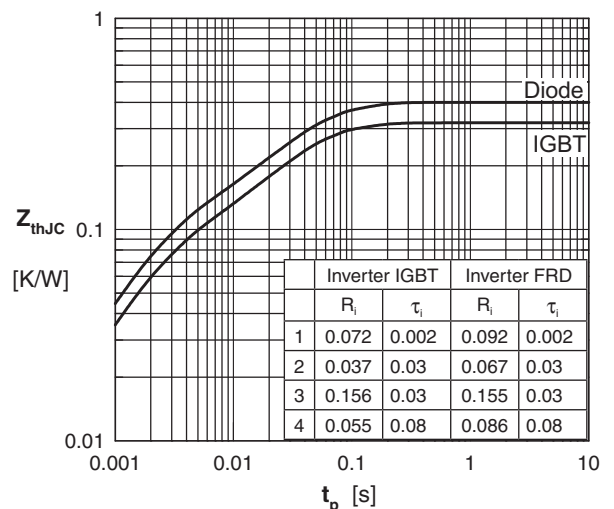

Fig. 12 Typ. transient thermal impedance

## Brake T7 & D7

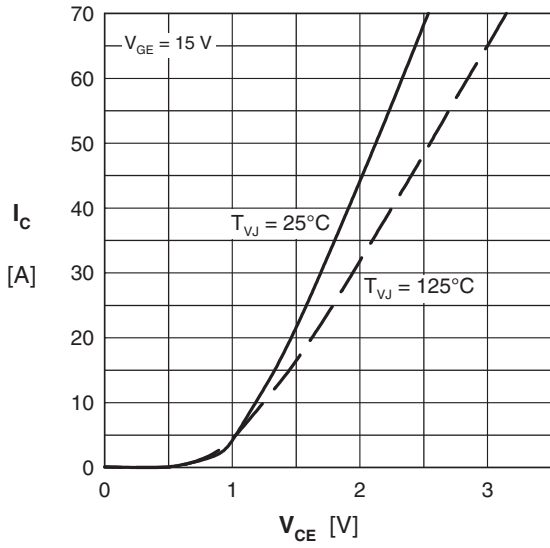

Fig. 13 Typ. output characteristics

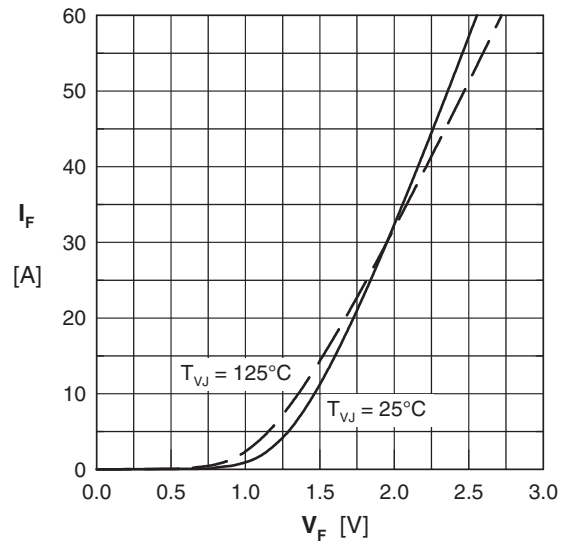

Fig. 14 Typ. forward characteristics

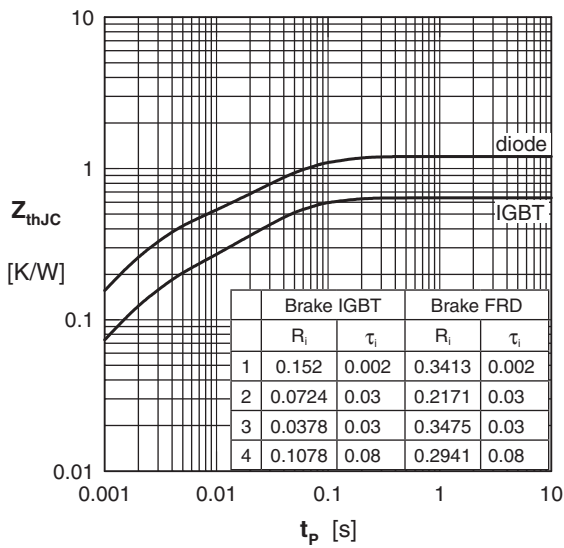

Fig. 15 Typ. transient thermal impedance

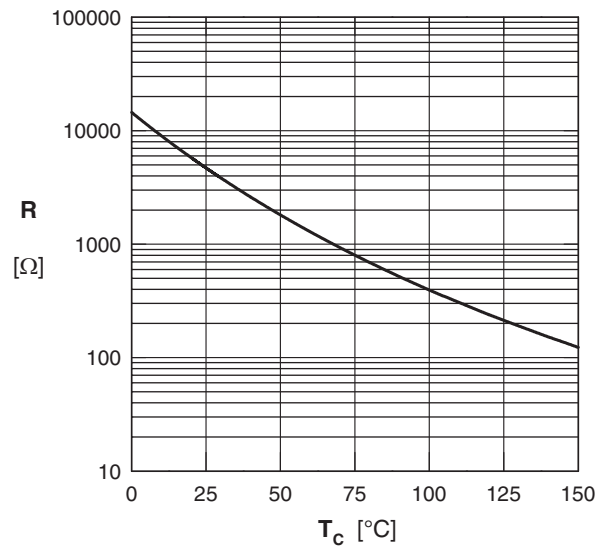

Fig. 16 Typ. NTC resistance vs. temperature



## Rectifier D11 - D16

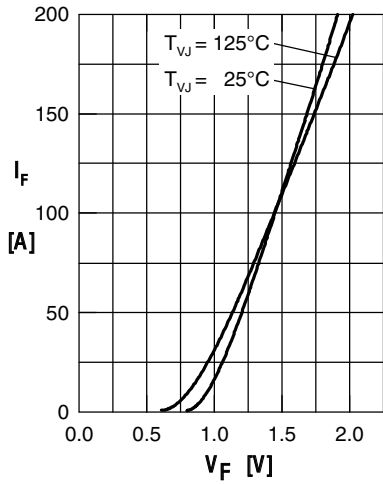

Fig. 1 Forward current vs. voltage drop per diode

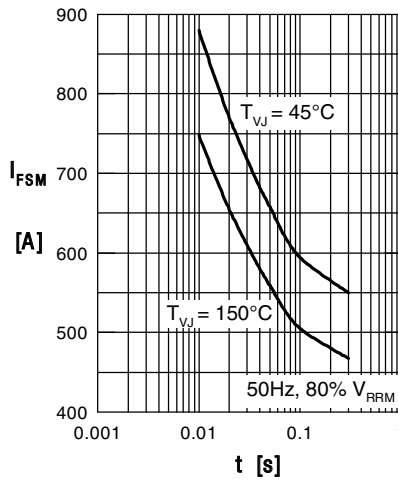

Fig. 2 Surge overload current vs. time per diode

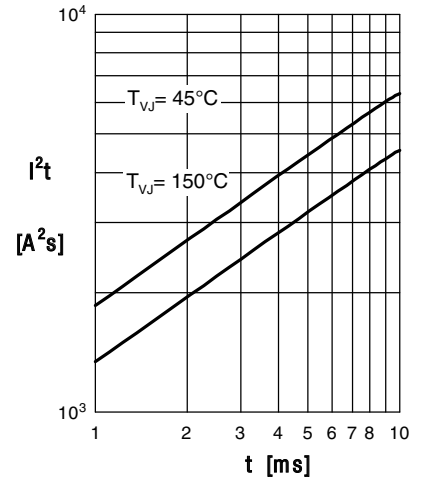

Fig. 3  $I^2t$  vs. time per diode

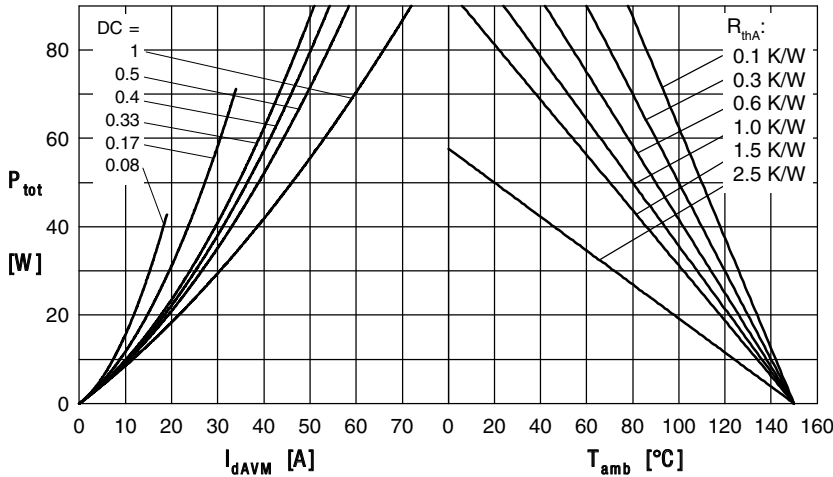

Fig. 4 Power dissipation vs. forward current and ambient temperature per diode

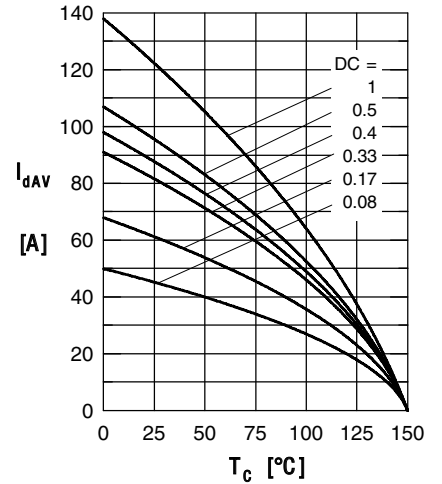

Fig. 5 Max. forward current vs. case temperature per diode

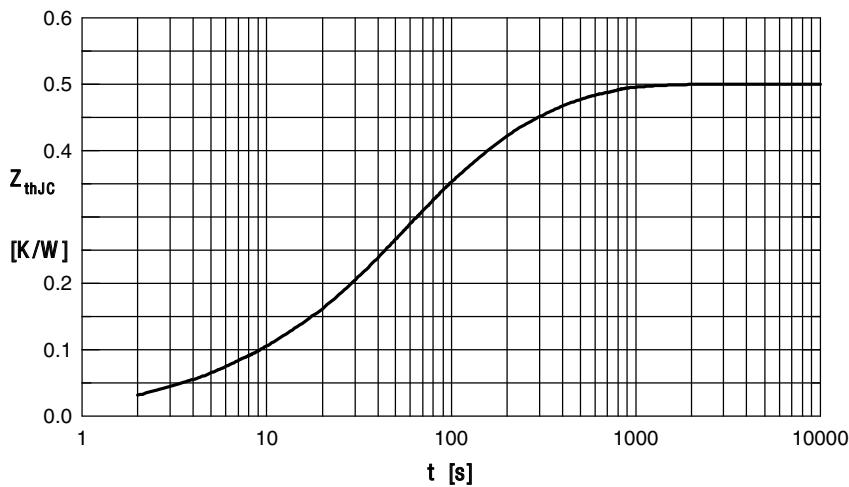

Fig. 6 Transient thermal impedance junction to case vs. time per diode

Constants for  $Z_{thJC}$  calculation:

i	$R_{th}$ (K/W)	$t_i$ (s)
1	0.040	0.004
2	0.003	0.010
3	0.140	0.030
4	0.120	0.300
5	0.197	0.080