

# Standard Rectifier Module

$$V_{RRM} = 2 \times 1600 \text{ V}$$

$$I_{FAV} = 280 \text{ A}$$

$$V_F = 1.05 \text{ V}$$

Phase leg

Part number

**MDMA280P1600YD**



Backside: isolated

 E72873



## Features / Advantages:

- Package with DCB ceramic
- Improved temperature and power cycling
- Planar passivated chips
- Very low forward voltage drop
- Very low leakage current

## Applications:

- Diode for main rectification
- For single and three phase bridge configurations
- Supplies for DC power equipment
- Input rectifiers for PWM inverter
- Battery DC power supplies
- Field supply for DC motors

## Package: Y4

- Isolation Voltage: 4800 V~
- Industry standard outline
- RoHS compliant
- Height: 30 mm
- Base plate: DCB ceramic
- Reduced weight
- Advanced power cycling

## Disclaimer Notice

Information furnished is believed to be accurate and reliable. However, users should independently evaluate the suitability of and test each product selected for their own applications. Littelfuse products are not designed for, and may not be used in, all applications. Read complete Disclaimer Notice at [www.littelfuse.com/disclaimer-electronics](http://www.littelfuse.com/disclaimer-electronics).

Rectifier				Ratings			
Symbol	Definition	Conditions		min.	typ.	max.	Unit
$V_{RSM}$	max. non-repetitive reverse blocking voltage					1700	V
$V_{RRM}$	max. repetitive reverse blocking voltage					1600	V
$I_R$	reverse current	$V_R = 1600$ V		$T_{VJ} = 25^\circ\text{C}$		1	mA
		$V_R = 1600$ V		$T_{VJ} = 150^\circ\text{C}$		20	mA
$V_F$	forward voltage drop	$I_F = 280$ A		$T_{VJ} = 25^\circ\text{C}$		1.14	V
		$I_F = 560$ A				1.36	V
		$I_F = 280$ A		$T_{VJ} = 125^\circ\text{C}$		1.05	V
		$I_F = 560$ A				1.32	V
$I_{FAV}$	average forward current	$T_C = 100^\circ\text{C}$		$T_{VJ} = 150^\circ\text{C}$		280	A
		rectangular	d = 0.5				
$V_{FO}$	threshold voltage			$T_{VJ} = 150^\circ\text{C}$		0.74	V
$r_F$	slope resistance					1	m $\Omega$
		} for power loss calculation only					
$R_{thJC}$	thermal resistance junction to case					0.13	K/W
$R_{thCH}$	thermal resistance case to heatsink				0.06		K/W
$P_{tot}$	total power dissipation			$T_C = 25^\circ\text{C}$		960	W
$I_{FSM}$	max. forward surge current	t = 10 ms; (50 Hz), sine		$T_{VJ} = 45^\circ\text{C}$		10.5	kA
		t = 8,3 ms; (60 Hz), sine		$V_R = 0$ V		11.3	kA
		t = 10 ms; (50 Hz), sine		$T_{VJ} = 150^\circ\text{C}$		8.93	kA
		t = 8,3 ms; (60 Hz), sine		$V_R = 0$ V		9.64	kA
$I^2t$	value for fusing	t = 10 ms; (50 Hz), sine		$T_{VJ} = 45^\circ\text{C}$		551.3	kA <sup>2</sup> s
		t = 8,3 ms; (60 Hz), sine		$V_R = 0$ V		535.0	kA <sup>2</sup> s
		t = 10 ms; (50 Hz), sine		$T_{VJ} = 150^\circ\text{C}$		398.3	kA <sup>2</sup> s
		t = 8,3 ms; (60 Hz), sine		$V_R = 0$ V		386.6	kA <sup>2</sup> s
$C_J$	junction capacitance	$V_R = 400$ V; f = 1 MHz		$T_{VJ} = 25^\circ\text{C}$		381	pF



Package Y4				Ratings			
Symbol	Definition	Conditions	min.	typ.	max.	Unit	
$I_{RMS}$	RMS current	per terminal			300	A	
$T_{VJ}$	virtual junction temperature		-40		150	°C	
$T_{op}$	operation temperature		-40		125	°C	
$T_{stg}$	storage temperature		-40		125	°C	
<b>Weight</b>					150	g	
$M_D$	mounting torque		2.25		2.75	Nm	
$M_T$	terminal torque		4.5		5.5	Nm	
$d_{Spp/APP}$	creepage distance on surface   striking distance through air	terminal to terminal	14.0	10.0		mm	
$d_{Spb/APb}$		terminal to backside	16.0	16.0		mm	
$V_{ISOL}$	isolation voltage	t = 1 second		4800		V	
		t = 1 minute	50/60 Hz, RMS; $I_{ISOL} \leq 1$ mA	4000		V	



Data Matrix: part no. (1-19), DC + PI (20-25), lot.no.# (26-31), blank (32), serial no.# (33-36)

**Part description**

- M = Module
- D = Diode
- M = Standard Rectifier
- A = (up to 1800V)
- 280 = Current Rating [A]
- P = Phase leg
- 1600 = Reverse Voltage [V]
- YD = Y4-M6

Ordering	Ordering Number	Marking on Product	Delivery Mode	Quantity	Code No.
Standard	MDMA280P1600YD	MDMA280P1600YD	Box	6	518448

Similar Part	Package	Voltage class
MDMA180P1600YD	Y4-M6	1600
MDMA210P1600YD	Y4-M6	1600

**Equivalent Circuits for Simulation**

\* on die level

$T_{VJ} = 150^{\circ}\text{C}$



**Rectifier**

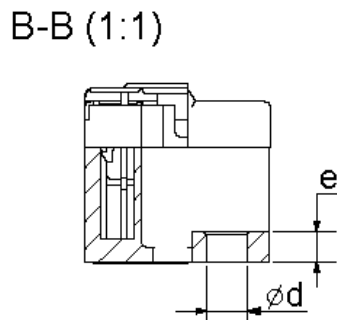
$V_{0\ max}$	threshold voltage	0.74	V
$R_{0\ max}$	slope resistance *	0.35	mΩ



**Outlines Y4**



Dim.	MIN [mm]	MAX [mm]	MIN [inch]	MAX [inch]
a	30.0	30.6	1.181	1.205
b	typ. 0.25		typ. 0.010	
c	64.0	65.0	2.520	2.559
d	6.5	7.0	0.256	0.275
e	4.9	5.1	0.193	0.201
h	93.5	94.5	3.681	3.720
i	79.5	80.5	3.130	3.169
k	33.4	34.0	1.315	1.339
l	16.7	17.3	0.657	0.681
m	22.7	23.3	0.894	0.917
n	22.7	23.3	0.894	0.917
o	14.0	15.0	0.551	0.591
p	typ. 10.5		typ. 0.413	



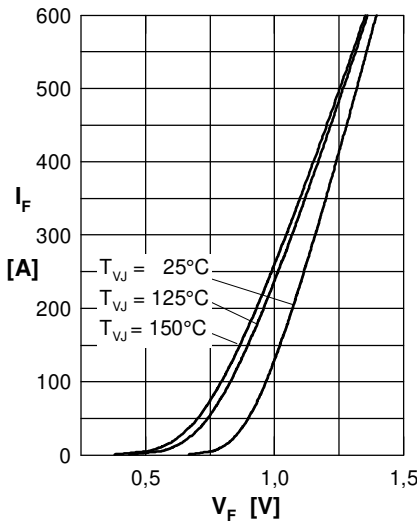
**Rectifier**


Fig. 1 Forward current versus voltage drop per diode

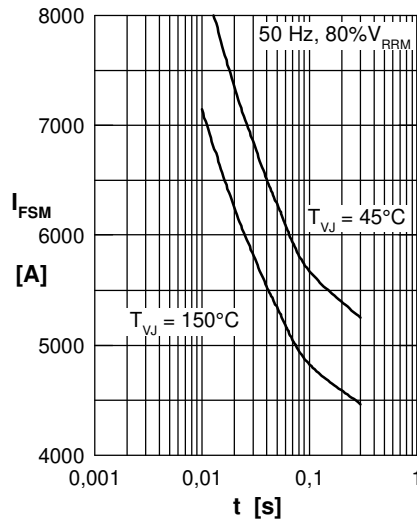


Fig. 2 Surge overload current vs. time per diode

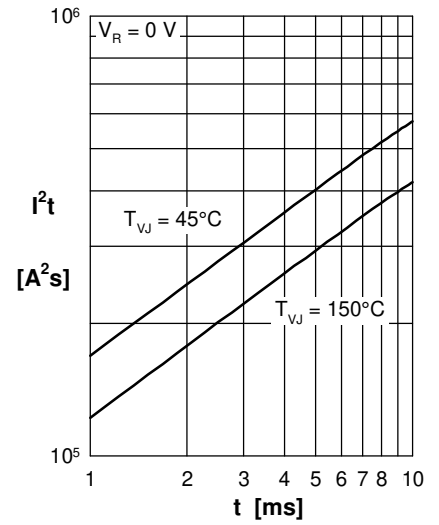
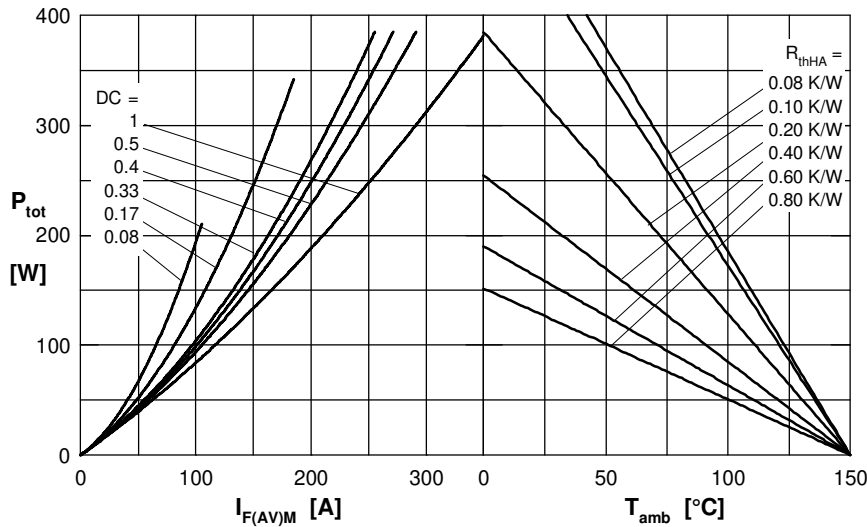

 Fig. 3  $I^2t$  versus time per diode


Fig. 4 Power dissipation vs. forward current and ambient temperature per diode

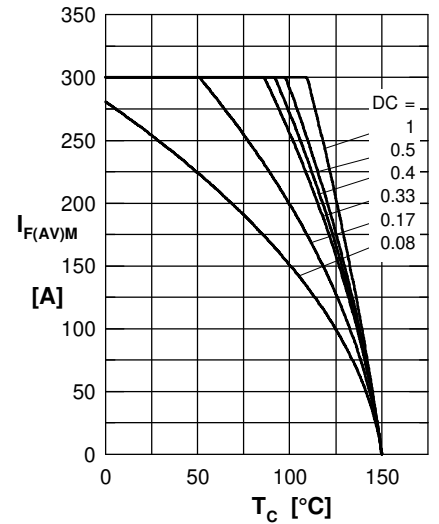


Fig. 5 Max. forward current vs. case temperature per diode

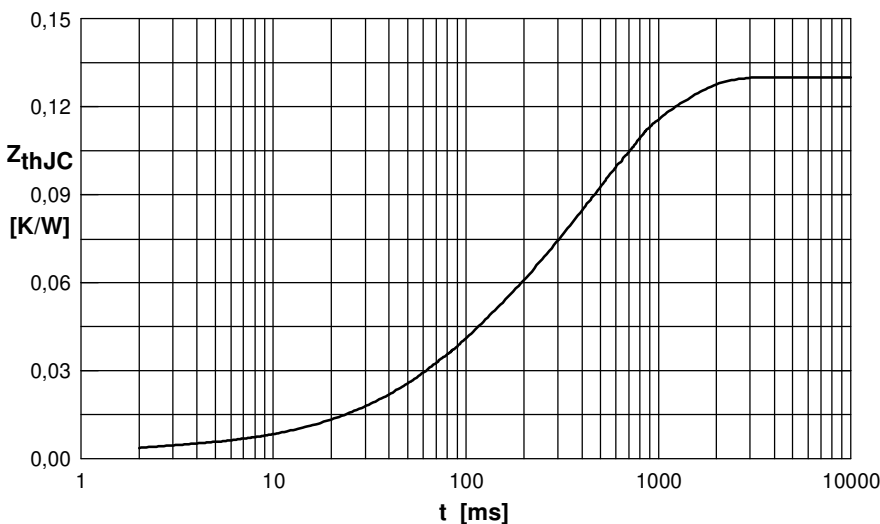


Fig. 6 Transient thermal impedance junction to case vs. time per diode

 Constants for  $Z_{thJC}$  calculation:

i	$R_{thi}$ (K/W)	$t_i$ (s)
1	0.003	0.0010
2	0.025	0.0700
3	0.045	0.3800
4	0.057	0.6100