

High Voltage Thyristor \ Diode Module

$$V_{RRM} = 2 \times 2200 \text{ V}$$

$$I_{TAV} = 180 \text{ A}$$

$$V_T = 1.18 \text{ V}$$

Phase leg

Part number

MCNA180PD2200YB



Backside: isolated

 E72873



Features / Advantages:

- Thyristor for line frequency
- Planar passivated chip
- Long-term stability

Applications:

- Line rectifying 50/60 Hz
- Softstart AC motor control
- DC Motor control
- Power converter
- AC power control
- Lighting and temperature control

Package: Y4

- Isolation Voltage: 4800 V~
- Industry standard outline
- RoHS compliant
- Soldering pins for PCB mounting
- Base plate: DCB ceramic
- Reduced weight
- Advanced power cycling

Disclaimer Notice

Information furnished is believed to be accurate and reliable. However, users should independently evaluate the suitability of and test each product selected for their own applications. Littelfuse products are not designed for, and may not be used in, all applications. Read complete Disclaimer Notice at www.littelfuse.com/disclaimer-electronics.



Rectifier			Ratings				
Symbol	Definition	Conditions	min.	typ.	max.	Unit	
$V_{RSM/DSM}$	max. non-repetitive reverse/forward blocking voltage				2300	V	
$V_{RRM/DRM}$	max. repetitive reverse/forward blocking voltage				2200	V	
I_{RD}	reverse current, drain current	$V_{R/D} = 2200\text{ V}$			400	μA	
		$V_{R/D} = 2200\text{ V}$			30	mA	
V_T	forward voltage drop	$I_T = 180\text{ A}$			1.24	V	
		$I_T = 360\text{ A}$			1.49	V	
		$I_T = 180\text{ A}$	$T_{VJ} = 125^\circ\text{C}$			1.18	V
		$I_T = 360\text{ A}$	$T_{VJ} = 125^\circ\text{C}$			1.51	V
I_{TAV}	average forward current	$T_C = 85^\circ\text{C}$			180	A	
$I_{T(RMS)}$	RMS forward current	180° sine			280	A	
V_{T0}	threshold voltage	} for power loss calculation only			0.85	V	
r_T	slope resistance				1.8	m Ω	
R_{thJC}	thermal resistance junction to case				0.17	K/W	
R_{thCH}	thermal resistance case to heatsink			0.09		K/W	
P_{tot}	total power dissipation		$T_C = 25^\circ\text{C}$		675	W	
I_{TSM}	max. forward surge current	$t = 10\text{ ms}; (50\text{ Hz}), \text{ sine}$	$T_{VJ} = 45^\circ\text{C}$		5.40	kA	
		$t = 8,3\text{ ms}; (60\text{ Hz}), \text{ sine}$	$V_R = 0\text{ V}$		5.83	kA	
		$t = 10\text{ ms}; (50\text{ Hz}), \text{ sine}$	$T_{VJ} = 140^\circ\text{C}$		4.59	kA	
		$t = 8,3\text{ ms}; (60\text{ Hz}), \text{ sine}$	$V_R = 0\text{ V}$		4.96	kA	
I^2t	value for fusing	$t = 10\text{ ms}; (50\text{ Hz}), \text{ sine}$	$T_{VJ} = 45^\circ\text{C}$		145.8	kA ² s	
		$t = 8,3\text{ ms}; (60\text{ Hz}), \text{ sine}$	$V_R = 0\text{ V}$		141.4	kA ² s	
		$t = 10\text{ ms}; (50\text{ Hz}), \text{ sine}$	$T_{VJ} = 140^\circ\text{C}$		105.3	kA ² s	
		$t = 8,3\text{ ms}; (60\text{ Hz}), \text{ sine}$	$V_R = 0\text{ V}$		102.1	kA ² s	
C_J	junction capacitance	$V_R = 700\text{ V}$ $f = 1\text{ MHz}$	$T_{VJ} = 25^\circ\text{C}$		146	pF	
P_{GM}	max. gate power dissipation	$t_p = 30\text{ }\mu\text{s}$	$T_C = 140^\circ\text{C}$		120	W	
		$t_p = 300\text{ }\mu\text{s}$			60	W	
P_{GAV}	average gate power dissipation				8	W	
$(di/dt)_{cr}$	critical rate of rise of current	$T_{VJ} = 140^\circ\text{C}; f = 50\text{ Hz}$ repetitive, $I_T = 540\text{ A}$			150	A/ μs	
		$t_p = 200\text{ }\mu\text{s}; di_G/dt = 0.5\text{ A}/\mu\text{s};$ $I_G = 0.5\text{ A}; V = \frac{2}{3} V_{DRM}$ non-repet., $I_T = 180\text{ A}$			500	A/ μs	
$(dv/dt)_{cr}$	critical rate of rise of voltage	$V = \frac{2}{3} V_{DRM}$ $R_{GK} = \infty$; method 1 (linear voltage rise)	$T_{VJ} = 140^\circ\text{C}$		1000	V/ μs	
V_{GT}	gate trigger voltage	$V_D = 6\text{ V}$	$T_{VJ} = 25^\circ\text{C}$		2	V	
			$T_{VJ} = -40^\circ\text{C}$		2.6	V	
I_{GT}	gate trigger current	$V_D = 6\text{ V}$	$T_{VJ} = 25^\circ\text{C}$		150	mA	
			$T_{VJ} = -40^\circ\text{C}$		200	mA	
V_{GD}	gate non-trigger voltage	$V_D = \frac{2}{3} V_{DRM}$	$T_{VJ} = 140^\circ\text{C}$		0.2	V	
I_{GD}	gate non-trigger current				10	mA	
I_L	latching current	$t_p = 30\text{ }\mu\text{s}$	$T_{VJ} = 25^\circ\text{C}$		200	mA	
		$I_G = 0.45\text{ A}; di_G/dt = 0.45\text{ A}/\mu\text{s}$					
I_H	holding current	$V_D = 6\text{ V}$ $R_{GK} = \infty$	$T_{VJ} = 25^\circ\text{C}$		200	mA	
t_{gd}	gate controlled delay time	$V_D = \frac{1}{2} V_{DRM}$	$T_{VJ} = 25^\circ\text{C}$		2	μs	
		$I_G = 0.5\text{ A}; di_G/dt = 0.5\text{ A}/\mu\text{s}$					
t_q	turn-off time	$V_R = 100\text{ V}; I_T = 180\text{ A}; V = \frac{2}{3} V_{DRM}$ $di/dt = 10\text{ A}/\mu\text{s}$ $dv/dt = 20\text{ V}/\mu\text{s}$ $t_p = 200\text{ }\mu\text{s}$	$T_{VJ} = 125^\circ\text{C}$		200	μs	



Package Y4		Ratings				
Symbol	Definition	Conditions	min.	typ.	max.	Unit
I_{RMS}	RMS current	per terminal			300	A
T_{VJ}	virtual junction temperature		-40		140	°C
T_{op}	operation temperature		-40		125	°C
T_{stg}	storage temperature		-40		125	°C
Weight				150		g
M_D	mounting torque		2.25		2.75	Nm
M_T	terminal torque		4.5		5.5	Nm
$d_{Spp/App}$	creepage distance on surface striking distance through air	terminal to terminal	14.0	10.0		mm
$d_{Spb/Apb}$		terminal to backside	16.0	16.0		mm
V_{ISOL}	isolation voltage	t = 1 second	4800			V
		t = 1 minute	4000			V



Data Matrix: part no. (1-19), DC + PI (20-25), lot.no.# (26-31), blank (32), serial no.# (33-36)

Part description

- M = Module
- C = Thyristor (SCR)
- N = High Voltage Thyristor
- A = (>= 2000V)
- 180 = Current Rating [A]
- PD = Phase leg
- 2200 = Reverse Voltage [V]
- YB = Y4-M6

Ordering	Ordering Number	Marking on Product	Delivery Mode	Quantity	Code No.
Standard	MCNA180PD2200YB	MCNA180PD2200YB	Box	6	520502

Similar Part	Package	Voltage class
MCNA150PD2200YB	Y4-M6	2200
MCNA220PD2200YB	Y4-M6	2200

Equivalent Circuits for Simulation

* on die level

$T_{VJ} = 140^{\circ}C$



Thyristor

$V_{0\ max}$	threshold voltage	0.85	V
$R_{0\ max}$	slope resistance *	1.18	mΩ



Outlines Y4

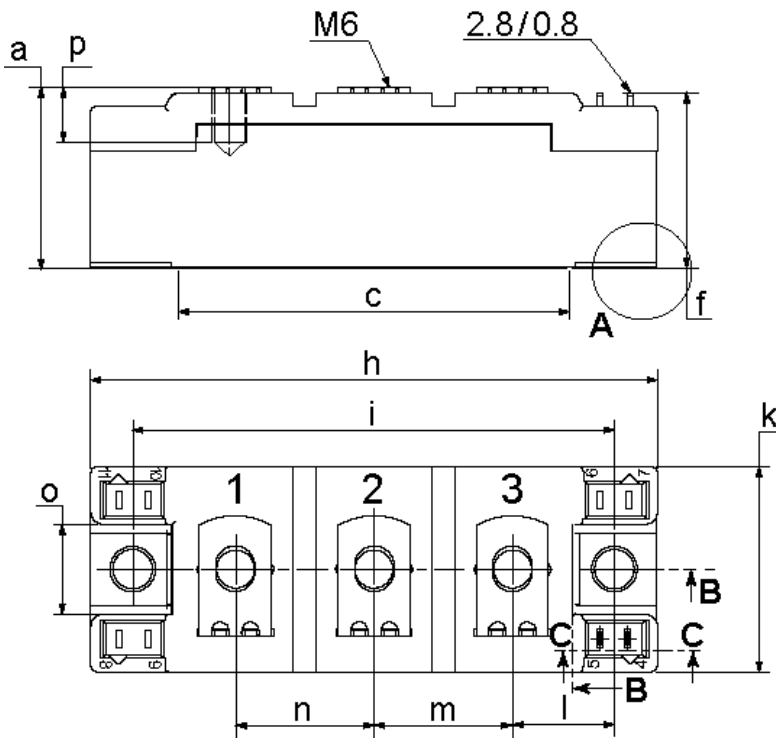

Dim.	MIN [mm]	MAX [mm]	MIN [inch]	MAX [inch]
a	30.0	30.6	1.181	1.205
b	typ. 0.25		typ. 0.010	
c	64.0	65.0	2.520	2.559
d	6.5	7.0	0.256	0.275
e	4.9	5.1	0.193	0.201
f	28.6	29.2	1.126	1.150
g	7.3	7.7	0.287	0.303
h	93.5	94.5	3.681	3.720
i	79.5	80.5	3.130	3.169
j	4.8	5.2	0.189	0.205
k	33.4	34.0	1.315	1.339
l	16.7	17.3	0.657	0.681
m	22.7	23.3	0.894	0.917
n	22.7	23.3	0.894	0.917
o	14.0	15.0	0.551	0.591
p	typ. 10.5		typ. 0.413	
r	1.8	2.4	0.071	0.041

Optional accessories for modules
Keyed gate/cathode twin plugs with wire length = 350 mm, gate = white, cathode = red
Type ZY 180L (L = Left for pin pair 4/5) UL 758, style 3751

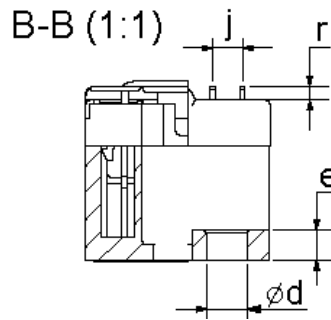

Thyristor

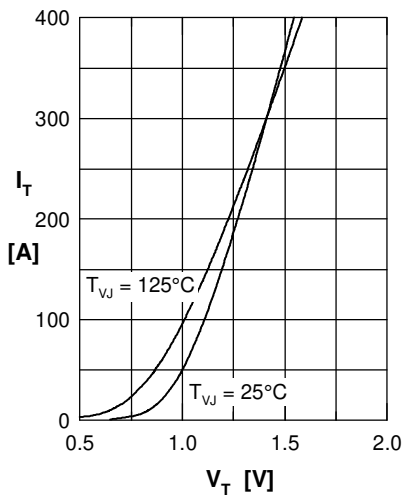

Fig. 1 Forward characteristics

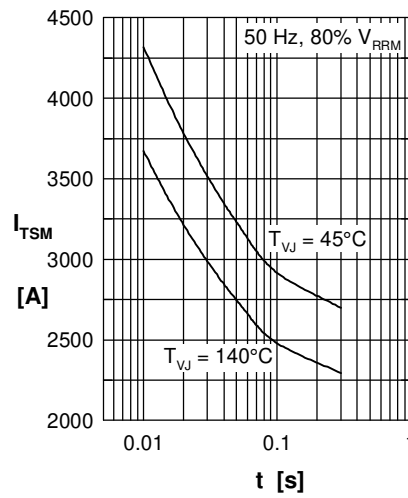

Fig. 2 Surge overload current
 I_{TSM} : crest value, t: duration

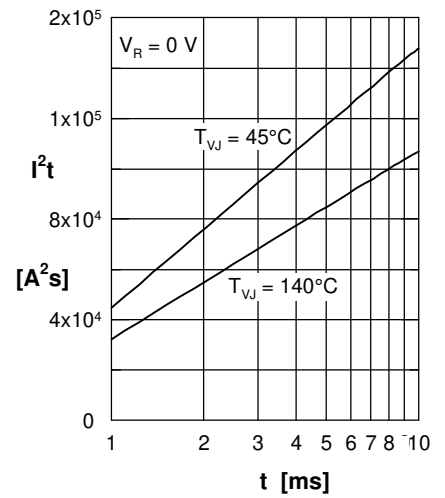

Fig. 3 I^2t versus time (1-10 s)

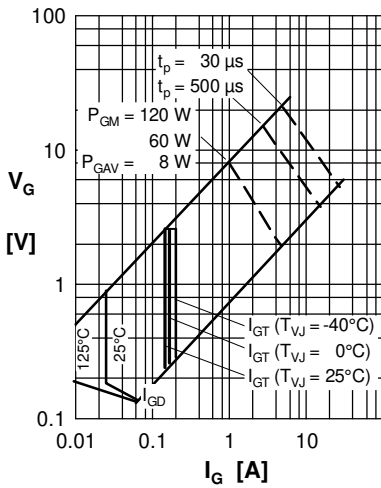

Fig. 4 Gate voltage & gate current

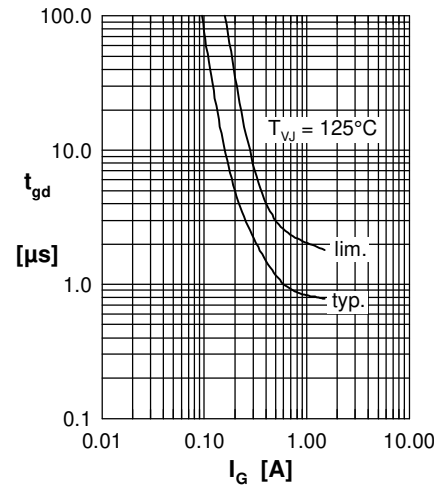

Fig. 5 Gate controlled delay time t_{gd}

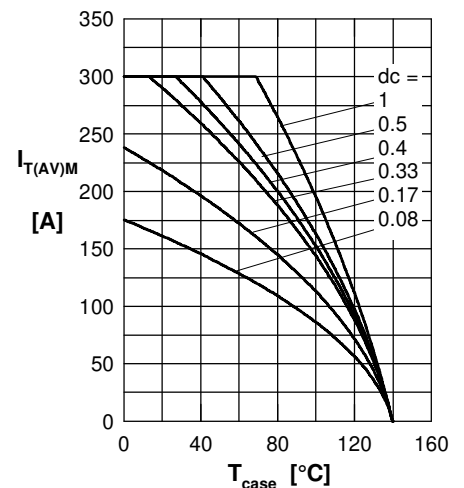

Fig. 6 Max. forward current at case temperature

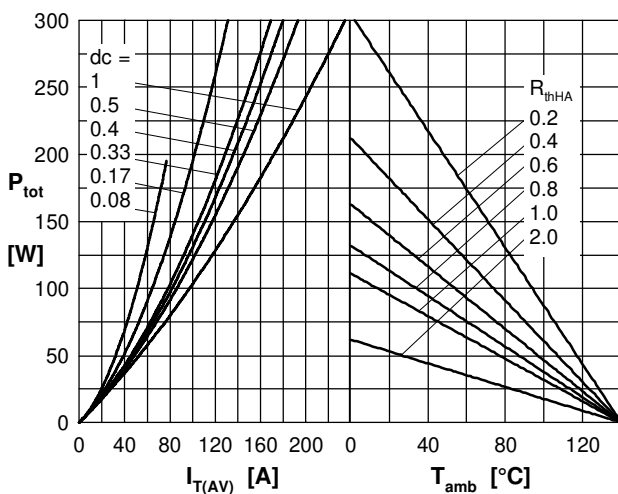

Fig. 7a Power dissipation versus direct output current
 Fig. 7b and ambient temperature

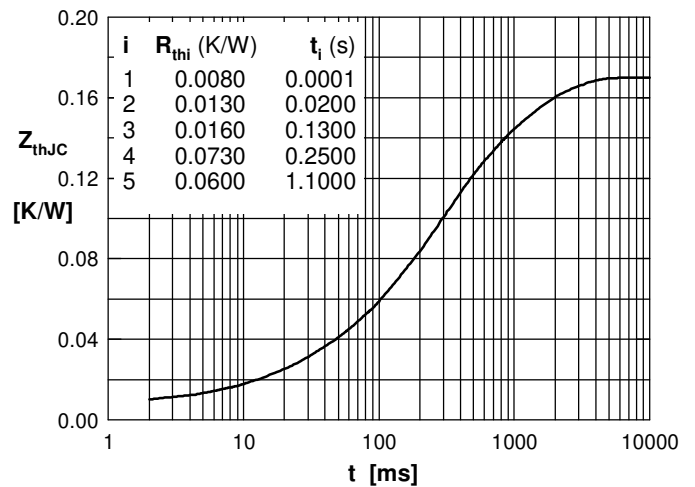

Fig. 8 Transient thermal impedance junction to case