

# Thyristor Module

$$V_{RRM} = 2 \times 1600 \text{ V}$$

$$I_{TAV} = 700 \text{ A}$$

$$V_T = 1,11 \text{ V}$$

Phase leg  
 optional usage as Dual Thyristor Triac

Part number

**MCMA700P1600NCA**

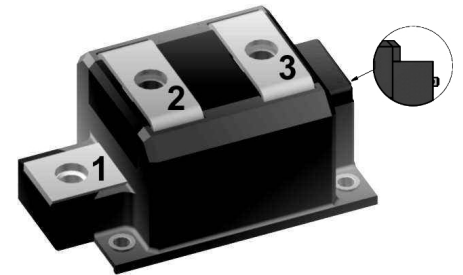

Backside: isolated

 E72873

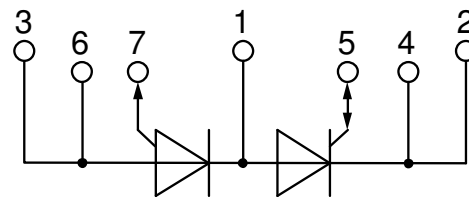

## Features / Advantages:

- Thyristor for line frequency
- Planar passivated chip
- Long-term stability
- Direct Copper Bonded Al<sub>2</sub>O<sub>3</sub>-ceramic
- Gate current polarities
  - upper SCR (2 -> 1) = positive/negative
  - lower SCR (1 -> 3) = negative

## Applications:

- Line rectifying 50/60 Hz
- Softstart AC motor control
- DC Motor control
- Power converter
- AC power control
- Lighting and temperature control

## Package: ComPack

- Isolation Voltage: 4800 V~
- Industry standard outline
- RoHS compliant
- Soldering pins for PCB mounting
- Base plate: Copper internally DCB isolated
- Advanced power cycling
- Phase Change Material available

## Disclaimer Notice

Information furnished is believed to be accurate and reliable. However, users should independently evaluate the suitability of and test each product selected for their own applications. Littelfuse products are not designed for, and may not be used in, all applications. Read complete Disclaimer Notice at [www.littelfuse.com/disclaimer-electronics](http://www.littelfuse.com/disclaimer-electronics).

Rectifier			Ratings			
Symbol	Definition	Conditions	min.	typ.	max.	Unit
$V_{RSM/DSM}$	max. non-repetitive reverse/forward blocking voltage	$T_{VJ} = 25^{\circ}\text{C}$			1700	V
$V_{RRM/DRM}$	max. repetitive reverse/forward blocking voltage	$T_{VJ} = 25^{\circ}\text{C}$			1600	V
$I_{RD}$	reverse current, drain current	$V_{R/D} = 1600\text{ V}$	$T_{VJ} = 25^{\circ}\text{C}$		2	mA
		$V_{R/D} = 1600\text{ V}$	$T_{VJ} = 125^{\circ}\text{C}$		40	mA
$V_T$	forward voltage drop	$I_T = 700\text{ A}$	$T_{VJ} = 25^{\circ}\text{C}$		1,16	V
		$I_T = 1400\text{ A}$			1,41	V
		$I_T = 700\text{ A}$	$T_{VJ} = 125^{\circ}\text{C}$		1,11	V
		$I_T = 1400\text{ A}$			1,41	V
$I_{TAV}$	average forward current	$T_C = 85^{\circ}\text{C}$	$T_{VJ} = 140^{\circ}\text{C}$		700	A
$I_{T(RMS)}$	RMS forward current	180° sine			1100	A
$V_{T0}$	threshold voltage	} for power loss calculation only	$T_{VJ} = 140^{\circ}\text{C}$		0,82	V
$r_T$	slope resistance				0,4	mΩ
$R_{thJC}$	thermal resistance junction to case				0,05	K/W
$R_{thCH}$	thermal resistance case to heatsink			0,02		K/W
$P_{tot}$	total power dissipation		$T_C = 25^{\circ}\text{C}$		2300	W
$I_{TSM}$	max. forward surge current	$t = 10\text{ ms}; (50\text{ Hz}), \text{ sine}$	$T_{VJ} = 45^{\circ}\text{C}$		19,0	kA
		$t = 8,3\text{ ms}; (60\text{ Hz}), \text{ sine}$	$V_R = 0\text{ V}$		20,5	kA
		$t = 10\text{ ms}; (50\text{ Hz}), \text{ sine}$	$T_{VJ} = 140^{\circ}\text{C}$		16,2	kA
		$t = 8,3\text{ ms}; (60\text{ Hz}), \text{ sine}$	$V_R = 0\text{ V}$		17,4	kA
$I^2t$	value for fusing	$t = 10\text{ ms}; (50\text{ Hz}), \text{ sine}$	$T_{VJ} = 45^{\circ}\text{C}$		1,81	MA <sup>2</sup> s
		$t = 8,3\text{ ms}; (60\text{ Hz}), \text{ sine}$	$V_R = 0\text{ V}$		1,75	MA <sup>2</sup> s
		$t = 10\text{ ms}; (50\text{ Hz}), \text{ sine}$	$T_{VJ} = 140^{\circ}\text{C}$		1,30	MA <sup>2</sup> s
		$t = 8,3\text{ ms}; (60\text{ Hz}), \text{ sine}$	$V_R = 0\text{ V}$		1,27	MA <sup>2</sup> s
$C_J$	junction capacitance	$V_R = 400\text{ V}$ $f = 1\text{ MHz}$	$T_{VJ} = 25^{\circ}\text{C}$		876	pF
$P_{GM}$	max. gate power dissipation	$t_p = 30\text{ }\mu\text{s}$	$T_C = 140^{\circ}\text{C}$		240	W
		$t_p = 300\text{ }\mu\text{s}$			120	W
$P_{GAV}$	average gate power dissipation				40	W
$(di/dt)_{cr}$	critical rate of rise of current	$T_{VJ} = 140^{\circ}\text{C}; f = 50\text{ Hz}$ repetitive, $I_T = 2100\text{ A}$			100	A/ $\mu\text{s}$
		$t_p = 200\text{ }\mu\text{s}; di_G/dt = 1\text{ A}/\mu\text{s};$ $I_G = 1\text{ A}; V_D = \frac{2}{3} V_{DRM}$ non-repet., $I_T = 700\text{ A}$			500	A/ $\mu\text{s}$
$(dv/dt)_{cr}$	critical rate of rise of voltage	$V_D = \frac{2}{3} V_{DRM}$ $R_{GK} = \infty$ ; method 1 (linear voltage rise)	$T_{VJ} = 140^{\circ}\text{C}$		1000	V/ $\mu\text{s}$
$V_{GT}$	gate trigger voltage	$V_D = 6\text{ V}$	$T_{VJ} = 25^{\circ}\text{C}$		2	V
			$T_{VJ} = -40^{\circ}\text{C}$		3	V
$I_{GT}$	gate trigger current	$V_D = 6\text{ V}$	$T_{VJ} = 25^{\circ}\text{C}$		$\pm 300$	mA
			$T_{VJ} = -40^{\circ}\text{C}$		$\pm 400$	mA
$V_{GD}$	gate non-trigger voltage	$V_D = \frac{2}{3} V_{DRM}$	$T_{VJ} = 140^{\circ}\text{C}$		0,25	V
$I_{GD}$	gate non-trigger current				$\pm 10$	mA
$I_L$	latching current	$t_p = 30\text{ }\mu\text{s}$	$T_{VJ} = 25^{\circ}\text{C}$		400	mA
		$I_G = 1\text{ A}; di_G/dt = 1\text{ A}/\mu\text{s}$				
$I_H$	holding current	$V_D = 6\text{ V}$ $R_{GK} = \infty$	$T_{VJ} = 25^{\circ}\text{C}$		300	mA
$t_{gd}$	gate controlled delay time	$V_D = \frac{1}{2} V_{DRM}$	$T_{VJ} = 25^{\circ}\text{C}$		2	$\mu\text{s}$
		$I_G = 1\text{ A}; di_G/dt = 1\text{ A}/\mu\text{s}$				
$t_q$	turn-off time	$V_R = 100\text{ V}; I_T = 700\text{ A}; V_D = \frac{2}{3} V_{DRM}$ $di/dt = 10\text{ A}/\mu\text{s}; dv/dt = 50\text{ V}/\mu\text{s}; t_p = 200\text{ }\mu\text{s}$	$T_{VJ} = 125^{\circ}\text{C}$		350	$\mu\text{s}$

Package ComPack		Ratings				
Symbol	Definition	Conditions	min.	typ.	max.	Unit
$I_{RMS}$	RMS current	per terminal			1200	A
$T_{VJ}$	virtual junction temperature		-40		140	°C
$T_{op}$	operation temperature		-40		125	°C
$T_{stg}$	storage temperature		-40		125	°C
<b>Weight</b>				500		g
$M_D$	mounting torque		3		5	Nm
$M_T$	terminal torque		12		14	Nm
$d_{Spp/App}$	creepage distance on surface   striking distance through air	terminal to terminal	21,0			mm
$d_{Spb/Apb}$		terminal to backside	18,0			mm
$V_{ISOL}$	isolation voltage	t = 1 second	4800			V
		t = 1 minute	4000			V

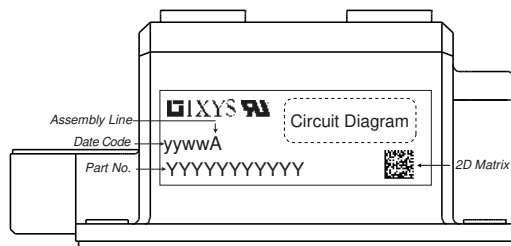
**Part description**

- M = Module
- C = Thyristor (SCR)
- M = Thyristor
- A = (up to 1800V)
- 700 = Current Rating [A]
- P = Phase leg
- 1600 = Reverse Voltage [V]
- N = Three Quadrants operation: QI - QIII
- CA = ComPack

Ordering	Ordering Number	Marking on Product	Delivery Mode	Quantity	Code No.
Standard	MCMA700P1600NCA	MCMA700P1600NCA	Box	3	515494

Similar Part	Package	Voltage class
MCMA700P1600CA	ComPack	1600

**Equivalent Circuits for Simulation**

\* on die level

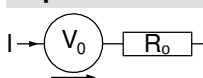
 $T_{VJ} = 140^{\circ}\text{C}$ 

**Thyristor**

$V_{0 \max}$	threshold voltage	0,82	V
$R_{0 \max}$	slope resistance *	0,21	mΩ

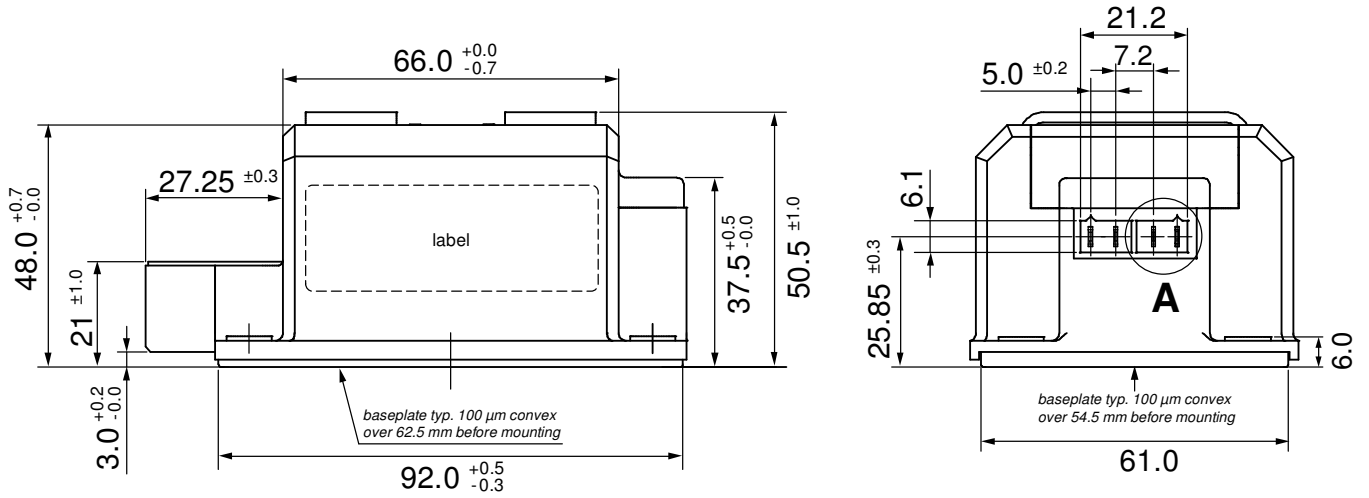

**Outlines ComPack**



Optional accessories for modules  
 Keyed gate/cathode twin plugs with  
 wire length = 350 mm, gate = white, cathode = red  
 Type ZY 180L (L = Left for pin pair 4/5) } UL 758,  
 Type ZY 180R (R = Right for pin pair 6/7) } style 3751

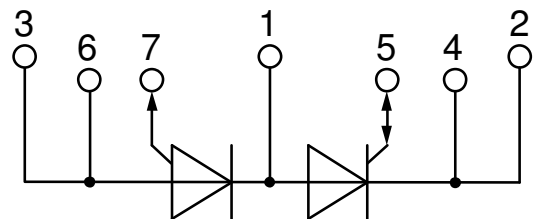
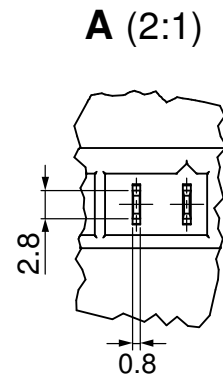
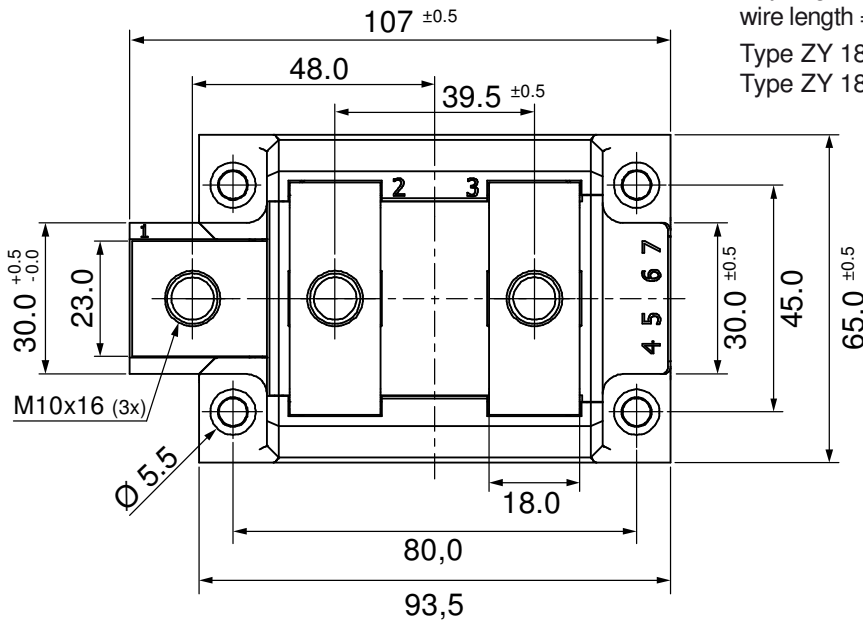

## Thyristor



Fig. 1 Forward characteristics

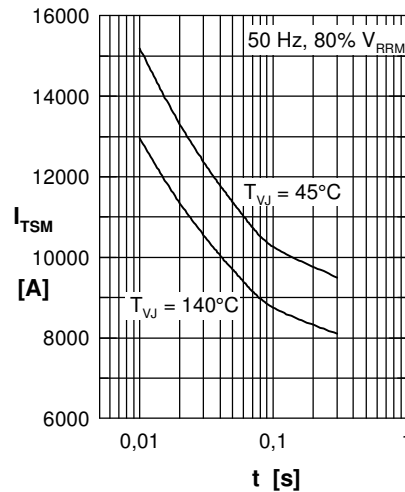

Fig. 2 Surge overload current  
 $I_{TSM}$ : crest value,  $t$ : duration

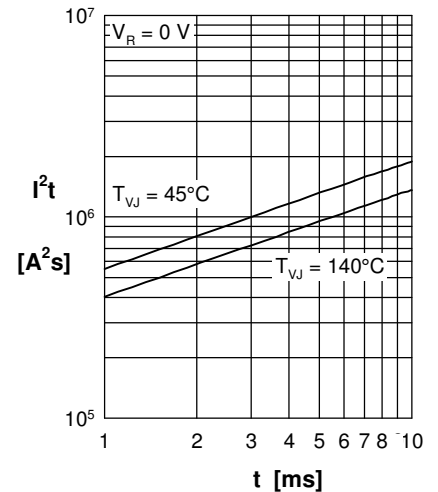

Fig. 3  $I^2t$  versus time (1-10 s)

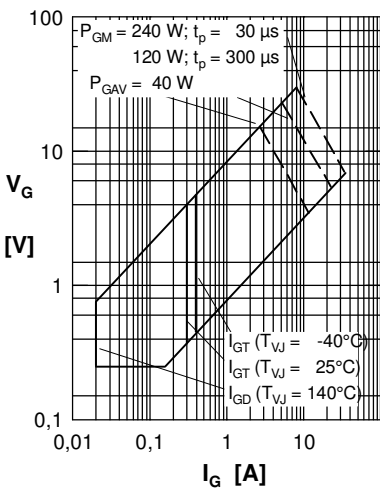

Fig. 4 Gate voltage & gate current

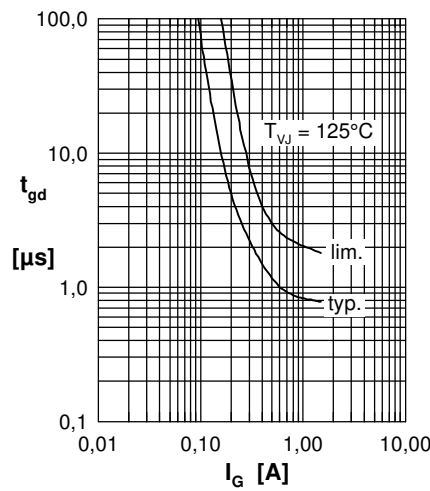

Fig. 5 Gate controlled delay time  $t_{gd}$

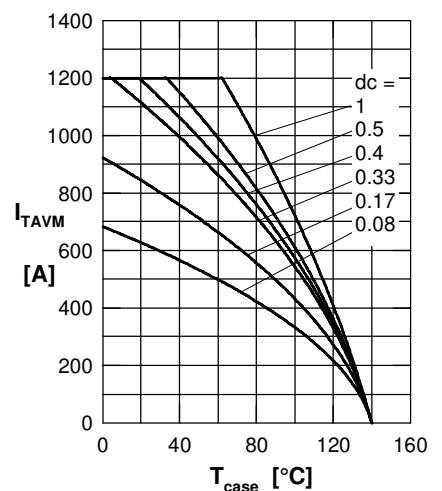

Fig. 6 Max. forward current at case temperature

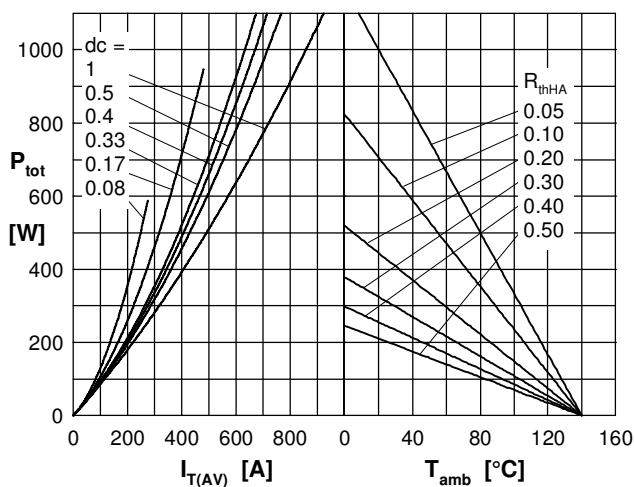

Fig. 7a Power dissipation versus direct output current  
 Fig. 7b and ambient temperature

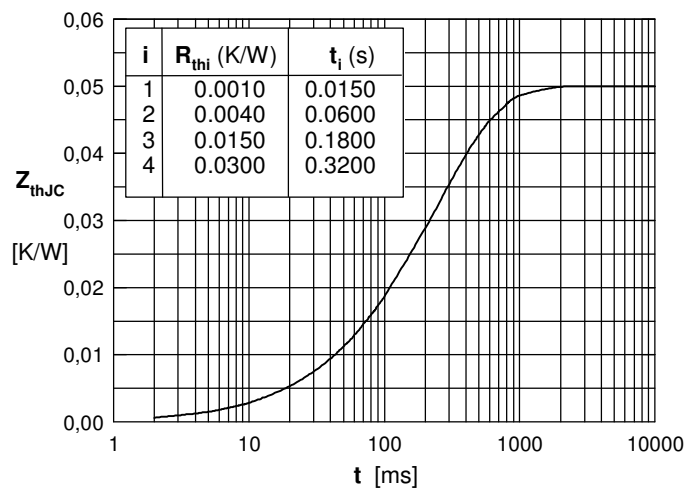

Fig. 8 Transient thermal impedance junction to case