

Thyristor Module

$$V_{RRM} = 2 \times 1600 \text{ V}$$

$$I_{TAV} = 700 \text{ A}$$

$$V_T = 1,11 \text{ V}$$

Phase leg
 optional usage as Dual Thyristor Triac

Part number

MCMA700P1600NCA

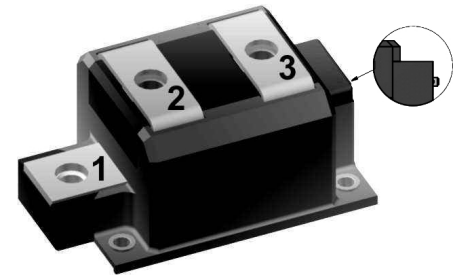

Backside: isolated

 E72873

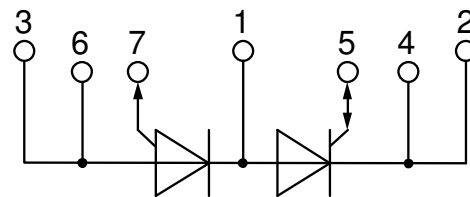

Features / Advantages:

- Thyristor for line frequency
- Planar passivated chip
- Long-term stability
- Direct Copper Bonded Al₂O₃-ceramic
- Gate current polarities
 - upper SCR (2 -> 1) = positive/negative
 - lower SCR (1 -> 3) = negative

Applications:

- Line rectifying 50/60 Hz
- Softstart AC motor control
- DC Motor control
- Power converter
- AC power control
- Lighting and temperature control

Package: ComPack

- Isolation Voltage: 4800 V~
- Industry standard outline
- RoHS compliant
- Soldering pins for PCB mounting
- Base plate: Copper internally DCB isolated
- Advanced power cycling
- Phase Change Material available

Disclaimer Notice

Information furnished is believed to be accurate and reliable. However, users should independently evaluate the suitability of and test each product selected for their own applications. Littelfuse products are not designed for, and may not be used in, all applications. Read complete Disclaimer Notice at www.littelfuse.com/disclaimer-electronics.

Rectifier			Ratings			
Symbol	Definition	Conditions	min.	typ.	max.	Unit
$V_{RSM/DSM}$	max. non-repetitive reverse/forward blocking voltage	$T_{VJ} = 25^{\circ}C$			1700	V
$V_{RRM/DRM}$	max. repetitive reverse/forward blocking voltage	$T_{VJ} = 25^{\circ}C$			1600	V
I_{RD}	reverse current, drain current	$V_{R/D} = 1600 V$	$T_{VJ} = 25^{\circ}C$		2	mA
		$V_{R/D} = 1600 V$	$T_{VJ} = 125^{\circ}C$		40	mA
V_T	forward voltage drop	$I_T = 700 A$	$T_{VJ} = 25^{\circ}C$		1,16	V
		$I_T = 1400 A$			1,41	V
		$I_T = 700 A$	$T_{VJ} = 125^{\circ}C$		1,11	V
		$I_T = 1400 A$			1,41	V
I_{TAV}	average forward current	$T_C = 85^{\circ}C$	$T_{VJ} = 140^{\circ}C$		700	A
$I_{T(RMS)}$	RMS forward current	180° sine			1100	A
V_{T0}	threshold voltage	} for power loss calculation only	$T_{VJ} = 140^{\circ}C$		0,82	V
r_T	slope resistance				0,4	mΩ
R_{thJC}	thermal resistance junction to case				0,05	K/W
R_{thCH}	thermal resistance case to heatsink			0,02		K/W
P_{tot}	total power dissipation		$T_C = 25^{\circ}C$		2300	W
I_{TSM}	max. forward surge current	$t = 10 \text{ ms}; (50 \text{ Hz}), \text{ sine}$	$T_{VJ} = 45^{\circ}C$		19,0	kA
		$t = 8,3 \text{ ms}; (60 \text{ Hz}), \text{ sine}$	$V_R = 0 V$		20,5	kA
		$t = 10 \text{ ms}; (50 \text{ Hz}), \text{ sine}$	$T_{VJ} = 140^{\circ}C$		16,2	kA
		$t = 8,3 \text{ ms}; (60 \text{ Hz}), \text{ sine}$	$V_R = 0 V$		17,4	kA
I^2t	value for fusing	$t = 10 \text{ ms}; (50 \text{ Hz}), \text{ sine}$	$T_{VJ} = 45^{\circ}C$		1,81	MA ² s
		$t = 8,3 \text{ ms}; (60 \text{ Hz}), \text{ sine}$	$V_R = 0 V$		1,75	MA ² s
		$t = 10 \text{ ms}; (50 \text{ Hz}), \text{ sine}$	$T_{VJ} = 140^{\circ}C$		1,30	MA ² s
		$t = 8,3 \text{ ms}; (60 \text{ Hz}), \text{ sine}$	$V_R = 0 V$		1,27	MA ² s
C_J	junction capacitance	$V_R = 400V \quad f = 1 \text{ MHz}$	$T_{VJ} = 25^{\circ}C$		876	pF
P_{GM}	max. gate power dissipation	$t_p = 30 \mu s$	$T_C = 140^{\circ}C$		240	W
		$t_p = 300 \mu s$			120	W
P_{GAV}	average gate power dissipation				40	W
$(di/dt)_{cr}$	critical rate of rise of current	$T_{VJ} = 140^{\circ}C; f = 50 \text{ Hz}$ repetitive, $I_T = 2100 A$			100	A/μs
		$t_p = 200 \mu s; di_G/dt = 1 A/\mu s;$ $I_G = 1 A; V_D = \frac{2}{3} V_{DRM}$ non-repet., $I_T = 700 A$			500	A/μs
$(dv/dt)_{cr}$	critical rate of rise of voltage	$V_D = \frac{2}{3} V_{DRM}$ $R_{GK} = \infty$; method 1 (linear voltage rise)	$T_{VJ} = 140^{\circ}C$		1000	V/μs
V_{GT}	gate trigger voltage	$V_D = 6 V$	$T_{VJ} = 25^{\circ}C$		2	V
			$T_{VJ} = -40^{\circ}C$		3	V
I_{GT}	gate trigger current	$V_D = 6 V$	$T_{VJ} = 25^{\circ}C$		± 300	mA
			$T_{VJ} = -40^{\circ}C$		± 400	mA
V_{GD}	gate non-trigger voltage	$V_D = \frac{2}{3} V_{DRM}$	$T_{VJ} = 140^{\circ}C$		0,25	V
I_{GD}	gate non-trigger current				± 10	mA
I_L	latching current	$t_p = 30 \mu s$	$T_{VJ} = 25^{\circ}C$		400	mA
		$I_G = 1 A; di_G/dt = 1 A/\mu s$				
I_H	holding current	$V_D = 6 V \quad R_{GK} = \infty$	$T_{VJ} = 25^{\circ}C$		300	mA
t_{gd}	gate controlled delay time	$V_D = \frac{1}{2} V_{DRM}$	$T_{VJ} = 25^{\circ}C$		2	μs
t_q	turn-off time	$I_G = 1 A; di_G/dt = 1 A/\mu s$	$V_R = 100 V; I_T = 700 A; V_D = \frac{2}{3} V_{DRM} \quad T_{VJ} = 125^{\circ}C$		350	μs
		$di/dt = 10 A/\mu s; dv/dt = 50 V/\mu s; t_p = 200 \mu s$				

Package ComPack		Ratings				
Symbol	Definition	Conditions	min.	typ.	max.	Unit
I_{RMS}	RMS current	per terminal			1200	A
T_{VJ}	virtual junction temperature		-40		140	°C
T_{op}	operation temperature		-40		125	°C
T_{stg}	storage temperature		-40		125	°C
Weight				500		g
M_D	mounting torque		3		5	Nm
M_T	terminal torque		12		14	Nm
$d_{Spp/App}$	creepage distance on surface striking distance through air	terminal to terminal	21,0			mm
$d_{Spb/Apb}$		terminal to backside	18,0			mm
V_{ISOL}	isolation voltage	t = 1 second	4800			V
		t = 1 minute	4000			V

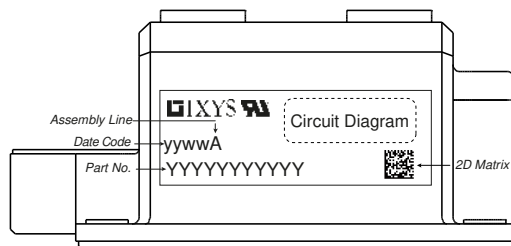
Part description

M = Module
 C = Thyristor (SCR)
 M = Thyristor
 A = (up to 1800V)
 700 = Current Rating [A]
 P = Phase leg
 1600 = Reverse Voltage [V]
 N = Three Quadrants operation: QI - QIII
 CA = ComPack

Ordering	Ordering Number	Marking on Product	Delivery Mode	Quantity	Code No.
Standard	MCMA700P1600NCA	MCMA700P1600NCA	Box	3	515494

Similar Part	Package	Voltage class
MCMA700P1600CA	ComPack	1600

Equivalent Circuits for Simulation

* on die level

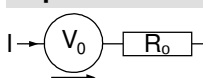
 $T_{VJ} = 140^{\circ}\text{C}$

Thyristor

$V_{0 \max}$	threshold voltage	0,82	V
$R_{0 \max}$	slope resistance *	0,21	mΩ

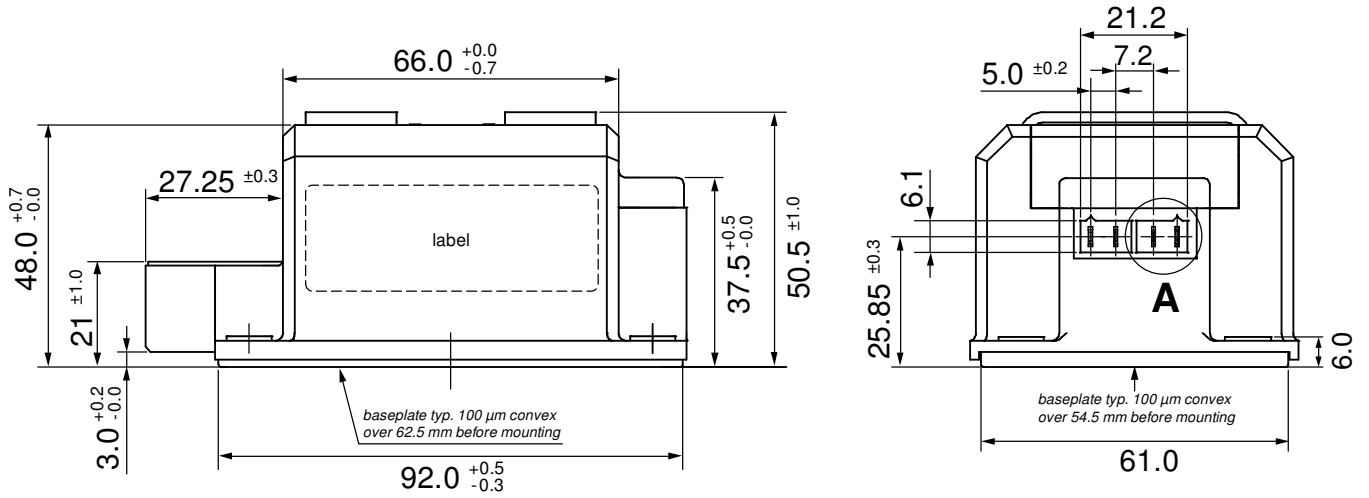

Outlines ComPack



Optional accessories for modules
 Keyed gate/cathode twin plugs with
 wire length = 350 mm, gate = white, cathode = red
 Type ZY 180L (L = Left for pin pair 4/5) } UL 758,
 Type ZY 180R (R = Right for pin pair 6/7) } style 3751

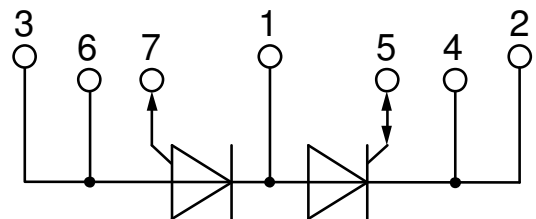
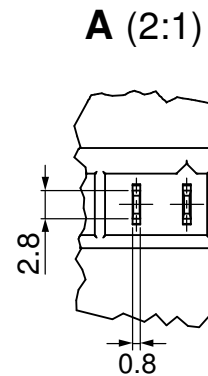
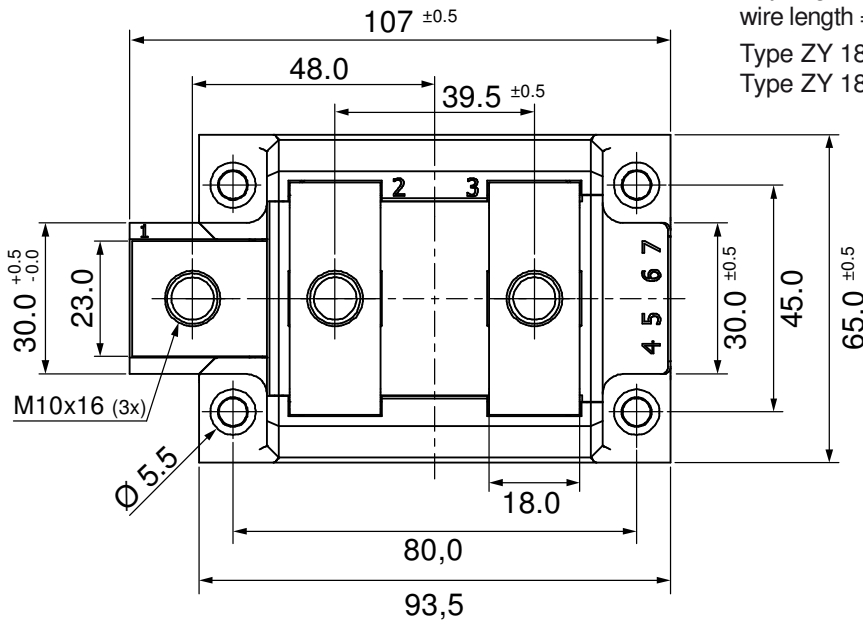

Thyristor

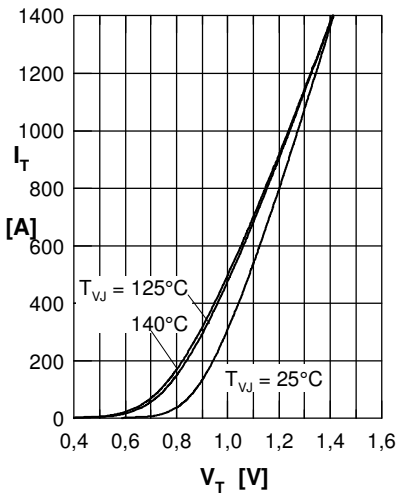

Fig. 1 Forward characteristics

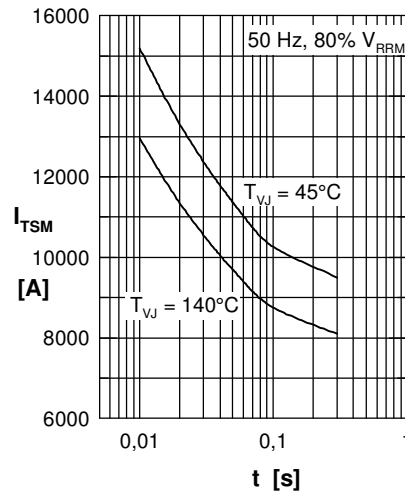

Fig. 2 Surge overload current
 I_{TSM} : crest value, t : duration

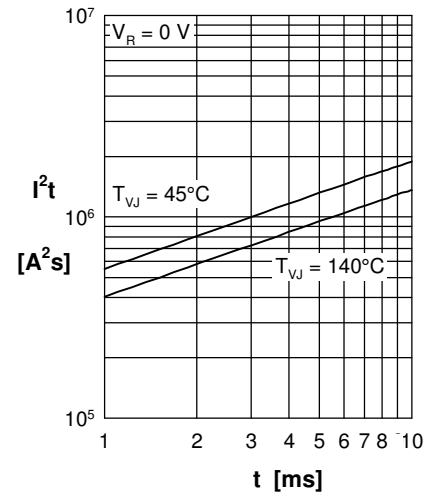

Fig. 3 I^2t versus time (1-10 s)

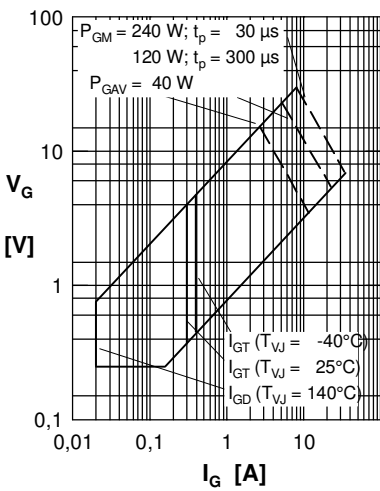

Fig. 4 Gate voltage & gate current

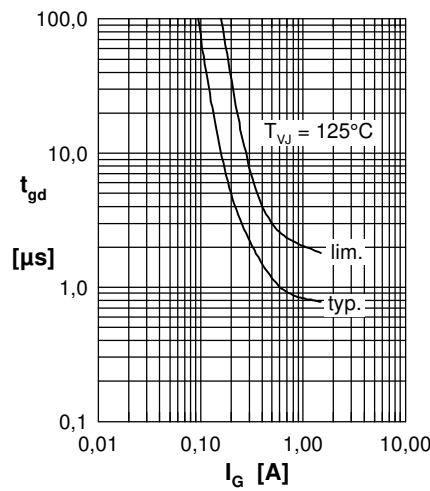

Fig. 5 Gate controlled delay time t_{gd}

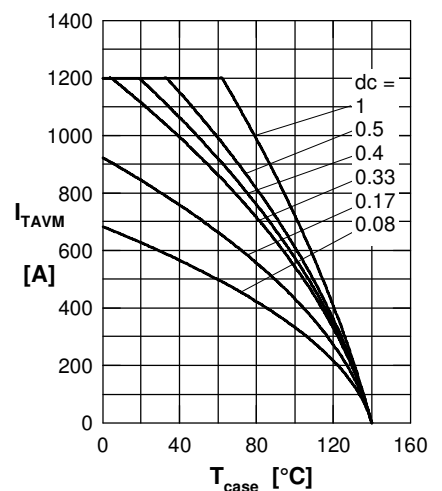

Fig. 6 Max. forward current at case temperature

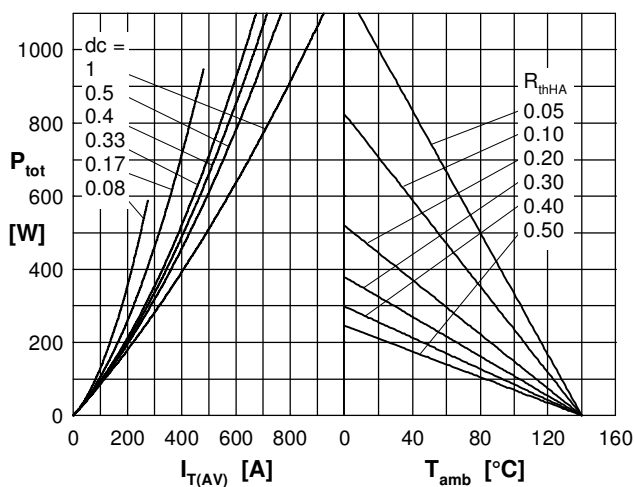

Fig. 7a Power dissipation versus direct output current
 Fig. 7b and ambient temperature

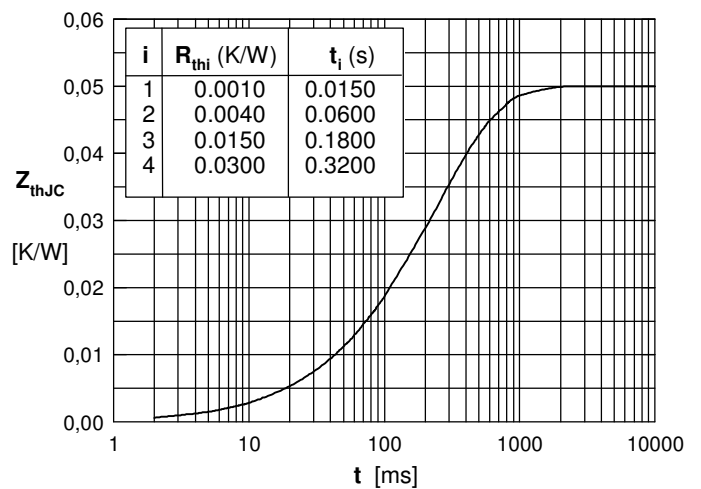

Fig. 8 Transient thermal impedance junction to case