

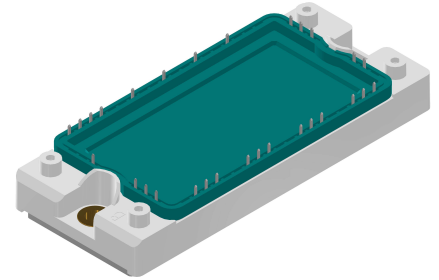
Thyristor Module

3~ Rectifier	Brake Chopper
$V_{RRM} = 1600 \text{ V}$	$V_{CES} = 1200 \text{ V}$
$I_{DAV} = 240 \text{ A}$	$I_{C25} = 180 \text{ A}$
$I_{FSM} = 1500 \text{ A}$	$V_{CE(sat)} = 1.7 \text{ V}$

3~ Rectifier Bridge, half-controlled (high-side) + Brake Unit

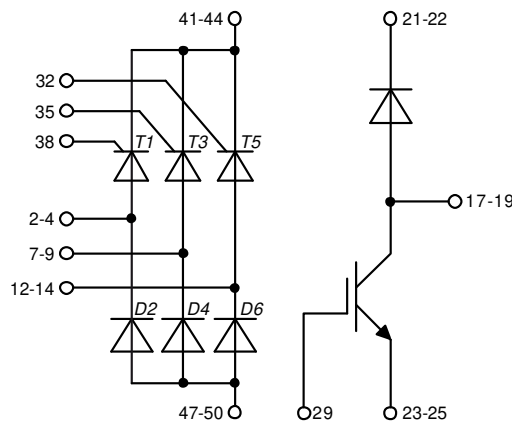
Part number

MCMA240UI1600ED



Backside: isolated

 E72873



Features / Advantages:

- Package with DCB ceramic
- Improved temperature and power cycling
- Planar passivated chips
- Very low forward voltage drop
- Very low leakage current
- X2PT - 2nd generation Xtreme light Punch Through
- Rugged X2PT design results in:
 - short circuit rated for 10 μsec .
 - very low gate charge
 - low EMI
 - square RBSOA @ 2x I_c
- Thin wafer technology combined with X2PT design results in a competitive low $V_{CE(sat)}$ and low thermal resistance

Applications:

- 3~ Rectifier with brake unit for drive inverters

Package: E2-Pack

- Isolation Voltage: 3600 V~
- Industry standard outline
- RoHS compliant
- Soldering pins for PCB mounting
- Height: 17 mm
- Base plate: Copper internally DCB isolated
- Advanced power cycling
- Phase Change Material available

Disclaimer Notice

Information furnished is believed to be accurate and reliable. However, users should independently evaluate the suitability of and test each product selected for their own applications. Littelfuse products are not designed for, and may not be used in, all applications. Read complete Disclaimer Notice at www.littelfuse.com/disclaimer-electronics.

Rectifier			Ratings			
Symbol	Definition	Conditions	min.	typ.	max.	Unit
$V_{RSM/DSM}$	max. non-repetitive reverse/forward blocking voltage	$T_{VJ} = 25^{\circ}C$			1700	V
$V_{RRM/DRM}$	max. repetitive reverse/forward blocking voltage	$T_{VJ} = 25^{\circ}C$			1600	V
I_{RD}	reverse current, drain current	$V_{R/D} = 1600 V$	$T_{VJ} = 25^{\circ}C$		100	μA
		$V_{R/D} = 1600 V$	$T_{VJ} = 150^{\circ}C$		20	mA
V_T	forward voltage drop	$I_T = 80 A$	$T_{VJ} = 25^{\circ}C$		1.27	V
		$I_T = 240 A$			1.89	V
		$I_T = 80 A$	$T_{VJ} = 125^{\circ}C$		1.26	V
		$I_T = 240 A$			2.05	V
I_{DAV}	bridge output current	$T_C = 80^{\circ}C$ rectangular $d = 120^{\circ}$	$T_{VJ} = 150^{\circ}C$		240	A
V_{T0}	threshold voltage	} for power loss calculation only	$T_{VJ} = 150^{\circ}C$		0.83	V
r_T	slope resistance				5.3	m Ω
R_{thJC}	thermal resistance junction to case				0.4	K/W
R_{thCH}	thermal resistance case to heatsink			0.1		K/W
P_{tot}	total power dissipation		$T_C = 25^{\circ}C$		312	W
I_{TSM}	max. forward surge current	$t = 10 ms$; (50 Hz), sine	$T_{VJ} = 45^{\circ}C$		1.50	kA
		$t = 8,3 ms$; (60 Hz), sine	$V_R = 0 V$		1.62	kA
		$t = 10 ms$; (50 Hz), sine	$T_{VJ} = 150^{\circ}C$		1.28	kA
		$t = 8,3 ms$; (60 Hz), sine	$V_R = 0 V$		1.38	kA
I^2t	value for fusing	$t = 10 ms$; (50 Hz), sine	$T_{VJ} = 45^{\circ}C$		11.3	kA ² s
		$t = 8,3 ms$; (60 Hz), sine	$V_R = 0 V$		10.9	kA ² s
		$t = 10 ms$; (50 Hz), sine	$T_{VJ} = 150^{\circ}C$		8.13	kA ² s
		$t = 8,3 ms$; (60 Hz), sine	$V_R = 0 V$		7.87	kA ² s
C_J	junction capacitance	$V_R = 400 V$ $f = 1 MHz$	$T_{VJ} = 25^{\circ}C$	74		pF
P_{GM}	max. gate power dissipation	$t_p = 30 \mu s$	$T_C = 150^{\circ}C$		10	W
		$t_p = 300 \mu s$			5	W
P_{GAV}	average gate power dissipation				0.5	W
$(di/dt)_{cr}$	critical rate of rise of current	$T_{VJ} = 150^{\circ}C$; $f = 50 Hz$ repetitive, $I_T = 240 A$			150	A/ μs
		$t_p = 200 \mu s$; $di_G/dt = 0.45 A/\mu s$; $I_G = 0.45 A$; $V = \frac{2}{3} V_{DRM}$ non-repet., $I_T = 80 A$			500	A/ μs
$(dv/dt)_{cr}$	critical rate of rise of voltage	$V = \frac{2}{3} V_{DRM}$ $R_{GK} = \infty$; method 1 (linear voltage rise)	$T_{VJ} = 150^{\circ}C$		1000	V/ μs
V_{GT}	gate trigger voltage	$V_D = 6 V$	$T_{VJ} = 25^{\circ}C$		1.5	V
			$T_{VJ} = -40^{\circ}C$		1.6	V
I_{GT}	gate trigger current	$V_D = 6 V$	$T_{VJ} = 25^{\circ}C$		95	mA
			$T_{VJ} = -40^{\circ}C$		200	mA
V_{GD}	gate non-trigger voltage	$V_D = \frac{2}{3} V_{DRM}$	$T_{VJ} = 150^{\circ}C$		0.2	V
I_{GD}	gate non-trigger current				10	mA
I_L	latching current	$t_p = 10 \mu s$	$T_{VJ} = 25^{\circ}C$		450	mA
		$I_G = 0.45 A$; $di_G/dt = 0.45 A/\mu s$				
I_H	holding current	$V_D = 6 V$ $R_{GK} = \infty$	$T_{VJ} = 25^{\circ}C$		200	mA
t_{gd}	gate controlled delay time	$V_D = \frac{1}{2} V_{DRM}$ $I_G = 0.45 A$; $di_G/dt = 0.45 A/\mu s$	$T_{VJ} = 25^{\circ}C$		2	μs
t_q	turn-off time	$V_R = 100 V$; $I_T = 80 A$; $V = \frac{2}{3} V_{DRM}$ $di/dt = 10 A/\mu s$ $dv/dt = 20 V/\mu s$ $t_p = 200 \mu s$	$T_{VJ} = 125^{\circ}C$	150		μs

Brake IGBT + Diode				Ratings			
Symbol	Definition	Conditions	min.	typ.	max.	Unit	
V_{CES}	collector emitter voltage	$T_{VJ} = 25^{\circ}\text{C}$			1200	V	
V_{GES}	max. DC gate voltage				± 20	V	
V_{GEM}	max. transient gate emitter voltage				± 30	V	
I_{C25}	collector current	$T_C = 25^{\circ}\text{C}$			180	A	
I_{C80}		$T_C = 80^{\circ}\text{C}$			140	A	
P_{tot}	total power dissipation	$T_C = 25^{\circ}\text{C}$			500	W	
$V_{CE(sat)}$	collector emitter saturation voltage	$I_C = 100\text{ A}; V_{GE} = 15\text{ V}$			1.7	V	
					1.9	V	
$V_{GE(th)}$	gate emitter threshold voltage	$I_C = 4\text{ mA}; V_{GE} = V_{CE}$	6	6.8	7.5	V	
I_{CES}	collector emitter leakage current	$V_{CE} = V_{CES}; V_{GE} = 0\text{ V}$			0.1	mA	
					0.1	mA	
I_{GES}	gate emitter leakage current	$V_{GE} = \pm 20\text{ V}$			500	nA	
$Q_{G(on)}$	total gate charge	$V_{CE} = 600\text{ V}; V_{GE} = 15\text{ V}; I_C = 100\text{ A}$		340		nC	
$t_{d(on)}$	turn-on delay time	inductive load $V_{CE} = 600\text{ V}; I_C = 100\text{ A}$ $V_{GE} = \pm 15\text{ V}; R_G = 6.8\ \Omega$	$T_{VJ} = 125^{\circ}\text{C}$		230	ns	
t_r	current rise time				70	ns	
$t_{d(off)}$	turn-off delay time				380	ns	
t_f	current fall time				230	ns	
E_{on}	turn-on energy per pulse				12.5	mJ	
E_{off}	turn-off energy per pulse				11.5	mJ	
RBSOA	reverse bias safe operating area	$V_{GE} = \pm 15\text{ V}; R_G = 6.8\ \Omega$					
I_{CM}		$V_{CEK} = 1200\text{ V}$			300	A	
SCSOA	short circuit safe operating area	$V_{CEK} = 1200\text{ V}$					
t_{SC}	short circuit duration	$V_{CE} = 720\text{ V}; V_{GE} = \pm 15$	$T_{VJ} = 125^{\circ}\text{C}$		10	μs	
I_{SC}	short circuit current	$R_G = 6.8\ \Omega$; non-repetitive		450		A	
R_{thJC}	thermal resistance junction to case				0.25	K/W	
R_{thCH}	thermal resistance case to heatsink			0.10		K/W	
Brake Diode							
V_{RRM}	max. repetitive reverse voltage				1200	V	
I_{F25}	forward current		$T_C = 25^{\circ}\text{C}$		88	A	
I_{F80}			$T_C = 80^{\circ}\text{C}$		59	A	
V_F	forward voltage	$I_F = 60\text{ A}$	$T_{VJ} = 25^{\circ}\text{C}$		2.20	V	
			$T_{VJ} = 125^{\circ}\text{C}$	1.95		V	
I_R	reverse current	$V_R = V_{RRM}$	$T_{VJ} = 25^{\circ}\text{C}$		0.1	mA	
			$T_{VJ} = 125^{\circ}\text{C}$		1.2	mA	
Q_{rr}	reverse recovery charge	$V_R = 600\text{ V}$ $-di_f/dt = 900\text{ A}/\mu\text{s}$ $I_F = 60\text{ A}; V_{GE} = 0\text{ V}$	$T_{VJ} = 125^{\circ}\text{C}$		9.6	μC	
I_{RM}	max. reverse recovery current				47	A	
t_{rr}	reverse recovery time				450	ns	
E_{rec}	reverse recovery energy				3	mJ	
R_{thJC}	thermal resistance junction to case				0.6	K/W	
R_{thCH}	thermal resistance case to heatsink			0.1		K/W	

Package E2-Pack		Ratings				
Symbol	Definition	Conditions	min.	typ.	max.	Unit
I_{RMS}	RMS current	per terminal			50	A
T_{VJ}	virtual junction temperature		-40		150	°C
T_{op}	operation temperature		-40		125	°C
T_{stg}	storage temperature		-40		125	°C
Weight				176		g
M_D	mounting torque		3		6	Nm
$d_{Spp/App}$	creepage distance on surface / striking distance through air	terminal to terminal	6.0			mm
$d_{Spb/Appb}$		terminal to backside	12.0			mm
V_{ISOL}	isolation voltage	t = 1 second t = 1 minute	3600 3000			V
		50/60 Hz, RMS; $I_{ISOL} \leq 1$ mA				V



Part description

M = Module
 C = Thyristor (SCR)
 M = Thyristor
 A = (up to 1800V)
 240 = Current Rating [A]
 UI = 3- Rectifier Bridge, half-controlled (high-side) + Brake Unit
 1600 = Reverse Voltage [V]
 ED = E2-Pack

Ordering	Ordering Number	Marking on Product	Delivery Mode	Quantity	Code No.
Standard	MCMA240UI1600ED	MCMA240UI1600ED	Box	6	520454

Equivalent Circuits for Simulation

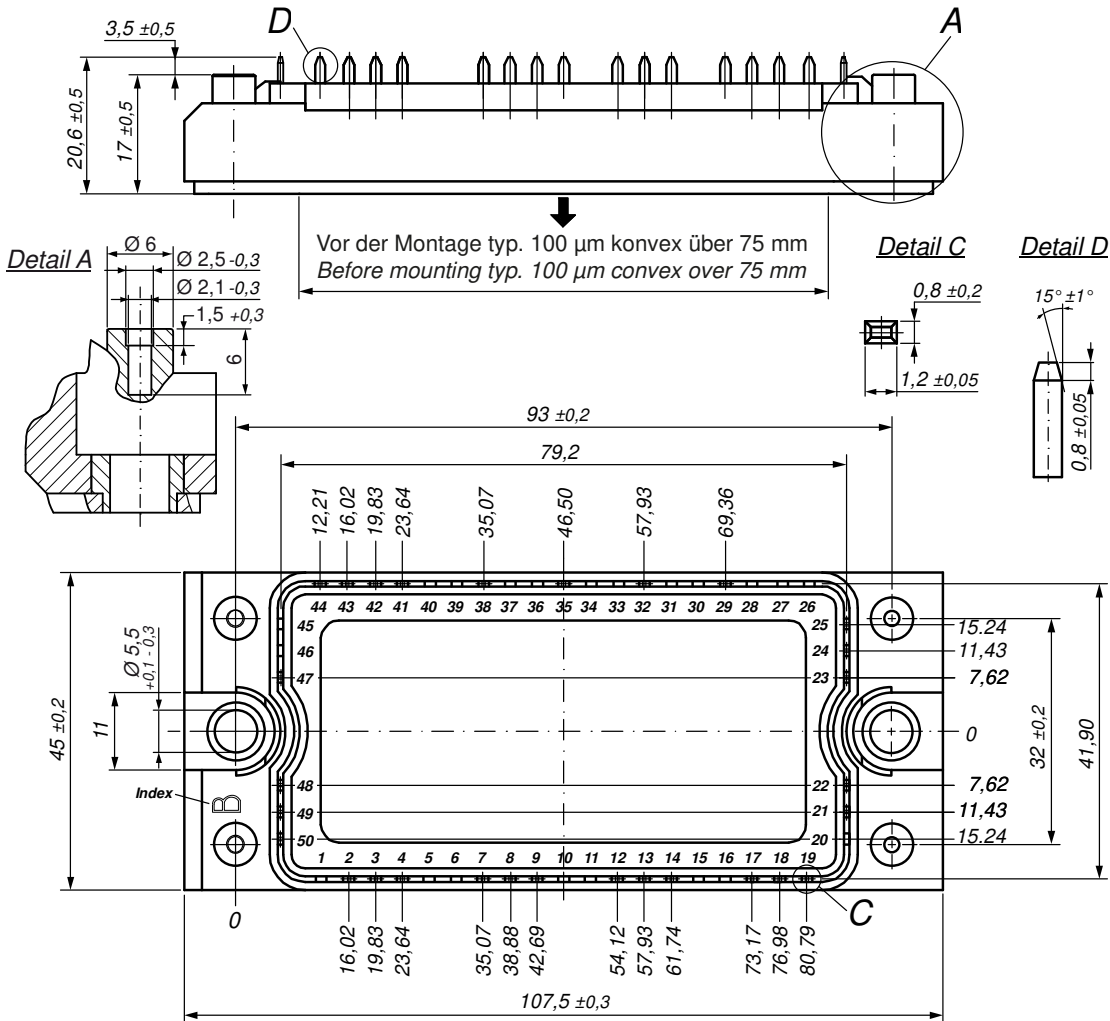
* on die level

$T_{VJ} = 150^{\circ}\text{C}$

		Thyristor	Brake IGBT +	Brake Diode	
V_0	threshold voltage	0.83	1.2	1.25	V
R_0	slope resistance *	2.7	11.6	8.5	mΩ



Outlines E2-Pack

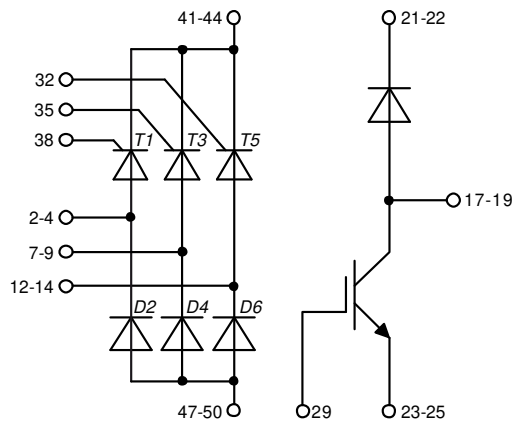


Bemerkung / Note:

- Nichttolerierete Maße nach / *Measure without tolerances according DIN ISO 2768-T1-m*
- PCB-Lochmuster / *PCB hole pattern: see pin position*
- Toleranz Pin-Position und PCB-Lochmuster / *Tolerance of pin position and PCB hole pattern: $\oplus 0.1$*
- Montageanleitung / *Mounting instruction: www.ixys.com Application note IXAN0024*

Detail A: PCB-Montage / *Mounting on PCB*

- Empfohlene, selbstschneidende Schraube / *Recommended, self-tapping screw: EJOT PT® (Größe / size: K25)*
- Max. Schraubenlänge / *Max. screw length: PCB-Dicke / thickness + 6 mm (max. Lochtiefe / hole depth)*
- Empfohlenes Drehmoment / *Recommended mounting torque: 1.5 Nm*



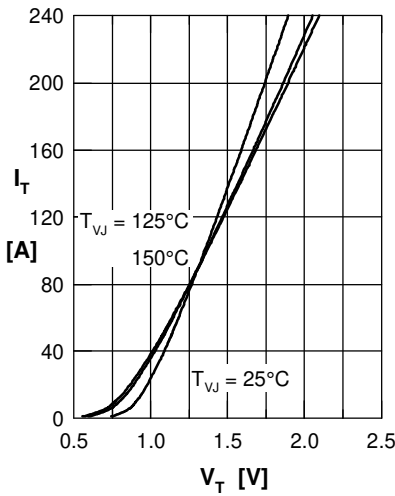
Thyristor


Fig. 1 Forward characteristics

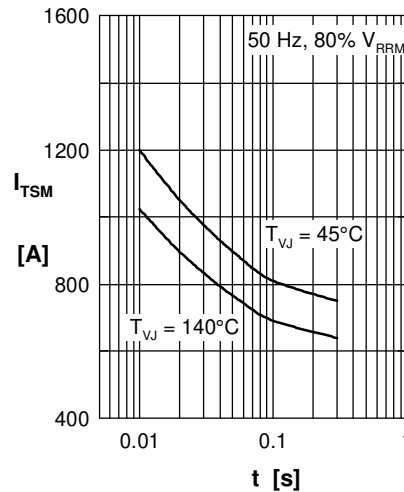
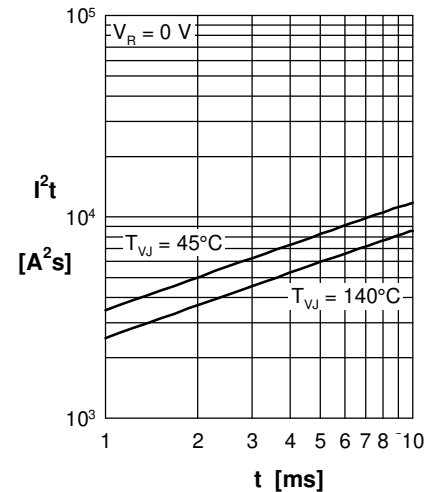
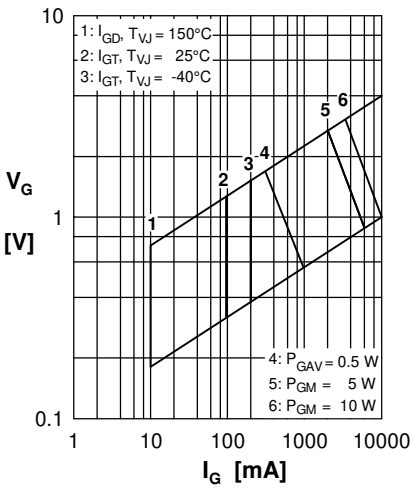

 Fig. 2 Surge overload current
 I_{TSM} : crest value, t : duration

 Fig. 3 I^2t versus time (1-10 s)


Fig. 4 Gate voltage & gate current

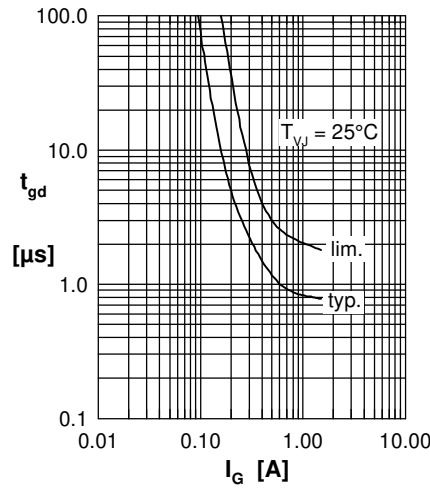
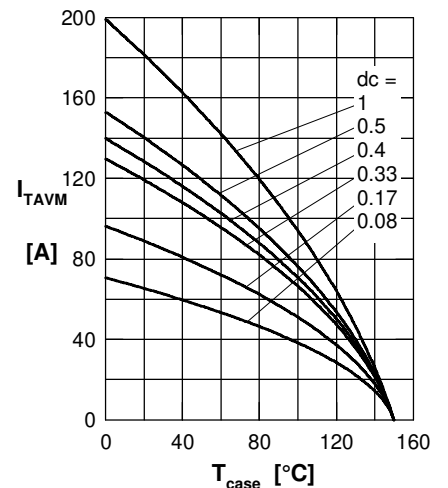

 Fig. 5 Gate controlled delay time t_{gd}


Fig. 6 Max. forward current at case temperature

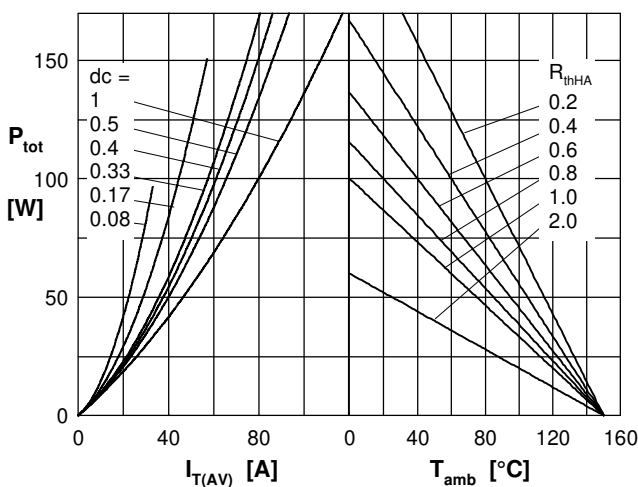
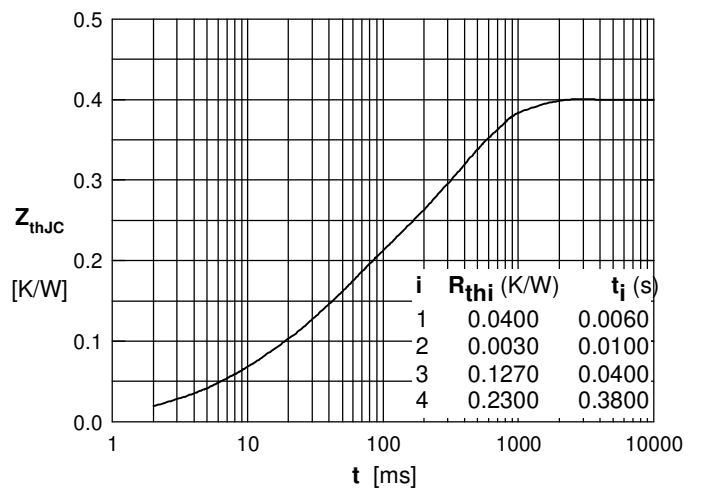

 Fig. 7a Power dissipation versus direct output current
 Fig. 7b and ambient temperature


Fig. 8 Transient thermal impedance junction to case

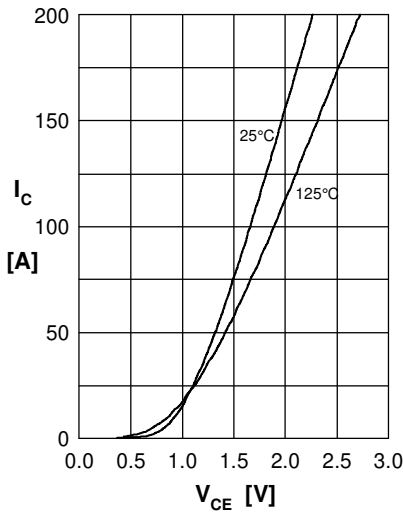
Brake IGBT + Diode


Fig.1 Output characteristics IGBT

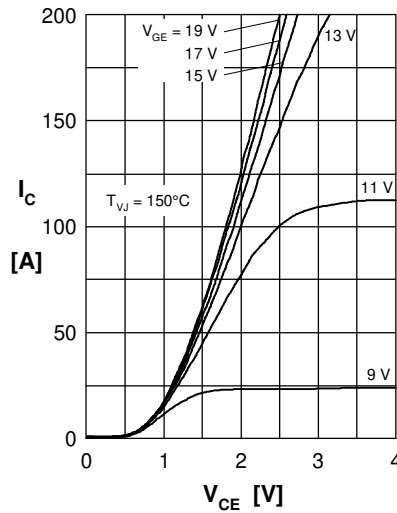


Fig.2 Typ. output characteristics IGBT

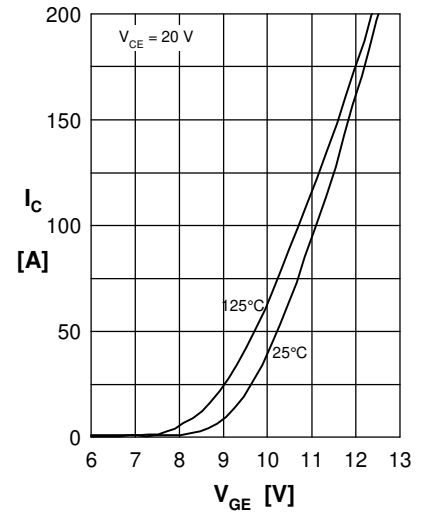


Fig.3 Typ. transfer charact. IGBT

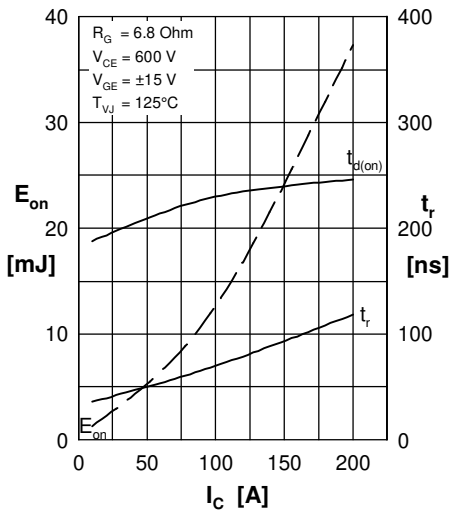


Fig.4 Typ. turn-on energy & switch. times vs. collector current

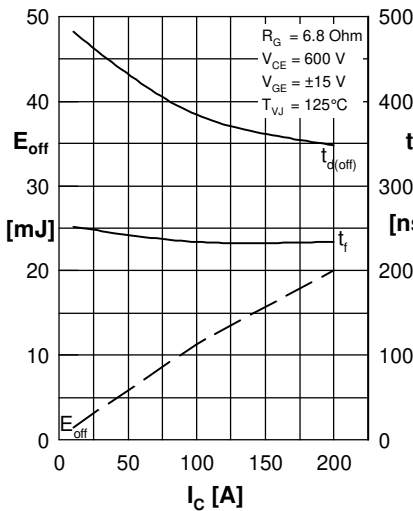


Fig.5 Typ. turn-off energy & switch. times vs. collector current

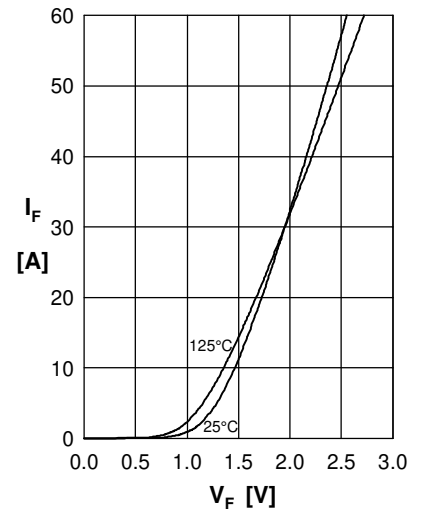
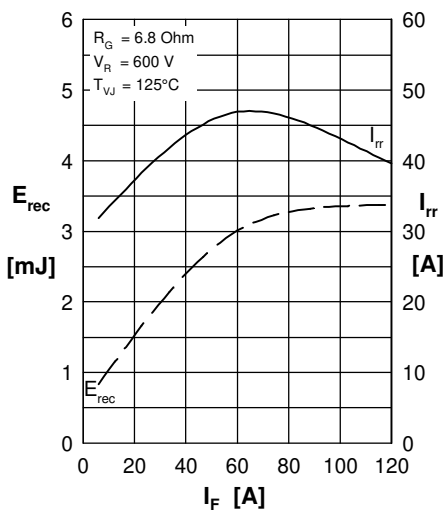

 Fig.6 Typ. forward current versus V_F


Fig.7 Typ. reverse recovery characteristics Diode

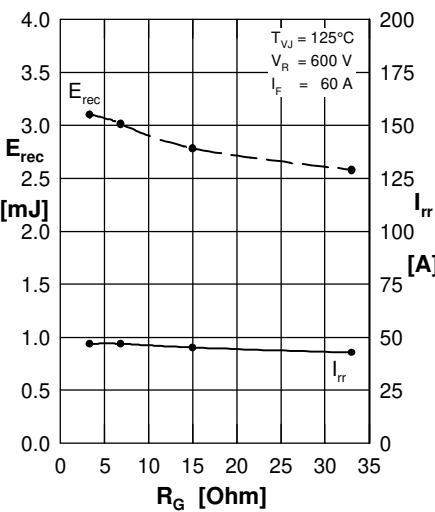


Fig.8 Typ. reverse recovery characteristics Diode

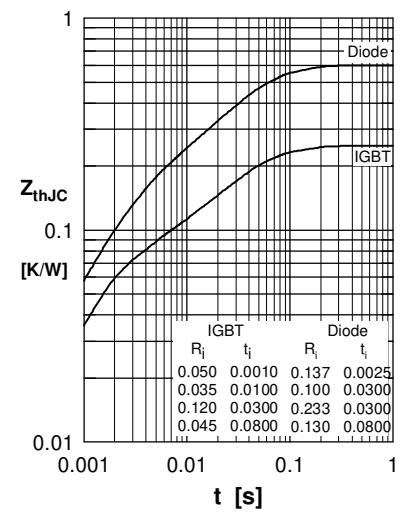


Fig.9 Transient thermal resistance junction to case