



Thyristor Module

$V_{RRM} = 2 \times 1800 \text{ V}$

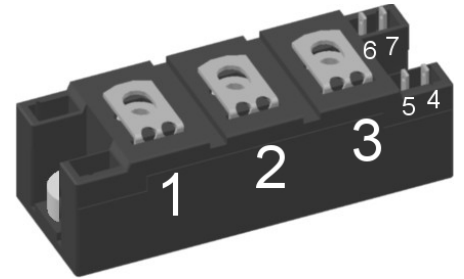
$I_{TAV} = 200 \text{ A}$

$V_T = 1.12 \text{ V}$

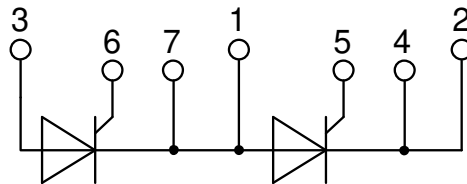
Phase leg

Part number

MCMA200P1800YA-MI



Backside: isolated



Features / Advantages:

- Thyristor for line frequency
- Planar passivated chip
- Long-term stability
- Direct Copper Bonded Al₂O₃-ceramic

Applications:

- Line rectifying 50/60 Hz
- Softstart AC motor control
- DC Motor control
- Power converter
- AC power control
- Lighting and temperature control

Package: Y4

- Isolation Voltage: 3600 V~
- Industry standard outline
- RoHS compliant
- Soldering pins for PCB mounting
- Base plate: DCB ceramic
- Reduced weight
- Advanced power cycling

Disclaimer Notice

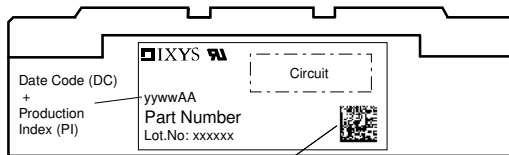
Information furnished is believed to be accurate and reliable. However, users should independently evaluate the suitability of and test each product selected for their own applications. Littelfuse products are not designed for, and may not be used in, all applications. Read complete Disclaimer Notice at www.littelfuse.com/disclaimer-electronics.



Thyristor				Ratings			
Symbol	Definition	Conditions	min.	typ.	max.	Unit	
$V_{RSM/DSM}$	max. non-repetitive reverse/forward blocking voltage	$T_{VJ} = 25^{\circ}C$			1900	V	
$V_{RRM/DRM}$	max. repetitive reverse/forward blocking voltage	$T_{VJ} = 25^{\circ}C$			1800	V	
$I_{R/D}$	reverse current, drain current	$V_{R/D} = 1800\text{ V}$	$T_{VJ} = 25^{\circ}C$		300	μA	
		$V_{R/D} = 1800\text{ V}$	$T_{VJ} = 140^{\circ}C$		10	mA	
V_T	forward voltage drop	$I_T = 200\text{ A}$	$T_{VJ} = 25^{\circ}C$		1.17	V	
		$I_T = 400\text{ A}$			1.40	V	
		$I_T = 200\text{ A}$	$T_{VJ} = 125^{\circ}C$		1.12	V	
		$I_T = 400\text{ A}$			1.41	V	
I_{TAV}	average forward current	$T_C = 85^{\circ}C$	$T_{VJ} = 140^{\circ}C$		200	A	
$I_{T(RMS)}$	RMS forward current	180° sine			315	A	
V_{T0}	threshold voltage	} for power loss calculation only	$T_{VJ} = 140^{\circ}C$		0.83	V	
r_T	slope resistance				1.43	m Ω	
R_{thJC}	thermal resistance junction to case				0.17	K/W	
R_{thCH}	thermal resistance case to heatsink			0.09		K/W	
P_{tot}	total power dissipation		$T_C = 25^{\circ}C$		680	W	
I_{TSM}	max. forward surge current	$t = 10\text{ ms}; (50\text{ Hz}), \text{ sine}$	$T_{VJ} = 45^{\circ}C$		6.00	kA	
		$t = 8,3\text{ ms}; (60\text{ Hz}), \text{ sine}$	$V_R = 0\text{ V}$		6.48	kA	
		$t = 10\text{ ms}; (50\text{ Hz}), \text{ sine}$	$T_{VJ} = 140^{\circ}C$		5.10	kA	
		$t = 8,3\text{ ms}; (60\text{ Hz}), \text{ sine}$	$V_R = 0\text{ V}$		5.51	kA	
I^2t	value for fusing	$t = 10\text{ ms}; (50\text{ Hz}), \text{ sine}$	$T_{VJ} = 45^{\circ}C$		180.0	kA ² s	
		$t = 8,3\text{ ms}; (60\text{ Hz}), \text{ sine}$	$V_R = 0\text{ V}$		174.7	kA ² s	
		$t = 10\text{ ms}; (50\text{ Hz}), \text{ sine}$	$T_{VJ} = 140^{\circ}C$		130.1	kA ² s	
		$t = 8,3\text{ ms}; (60\text{ Hz}), \text{ sine}$	$V_R = 0\text{ V}$		126.3	kA ² s	
C_J	junction capacitance	$V_R = 400\text{ V}$ $f = 1\text{ MHz}$	$T_{VJ} = 25^{\circ}C$		273	pF	
P_{GM}	max. gate power dissipation	$t_p = 30\text{ }\mu s$	$T_C = 140^{\circ}C$		120	W	
		$t_p = 500\text{ }\mu s$			60	W	
P_{GAV}	average gate power dissipation				8	W	
$(di/dt)_{cr}$	critical rate of rise of current	$T_{VJ} = 140^{\circ}C; f = 50\text{ Hz}$ repetitive, $I_T = 600\text{ A}$			100	A/ μs	
		$t_p = 200\text{ }\mu s; di_G/dt = 0.5\text{ A}/\mu s;$					
$(dv/dt)_{cr}$	critical rate of rise of voltage	$I_G = 0.5\text{ A}; V = \frac{2}{3} V_{DRM}$ non-repet., $I_T = 200\text{ A}$			1000	A/ μs	
		$V = \frac{2}{3} V_{DRM}$ $T_{VJ} = 140^{\circ}C$			1000	V/ μs	
V_{GT}	gate trigger voltage	$V_D = 6\text{ V}$	$T_{VJ} = 25^{\circ}C$		2.5	V	
			$T_{VJ} = -40^{\circ}C$		2.6	V	
I_{GT}	gate trigger current	$V_D = 6\text{ V}$	$T_{VJ} = 25^{\circ}C$		150	mA	
			$T_{VJ} = -40^{\circ}C$		200	mA	
V_{GD}	gate non-trigger voltage	$V_D = \frac{2}{3} V_{DRM}$	$T_{VJ} = 140^{\circ}C$		0.2	V	
I_{GD}	gate non-trigger current				10	mA	
I_L	latching current	$t_p = 30\text{ }\mu s$	$T_{VJ} = 25^{\circ}C$		300	mA	
		$I_G = 0.5\text{ A}; di_G/dt = 0.5\text{ A}/\mu s$					
I_H	holding current	$V_D = 6\text{ V}$ $R_{GK} = \infty$	$T_{VJ} = 25^{\circ}C$		200	mA	
t_{gd}	gate controlled delay time	$V_D = \frac{1}{2} V_{DRM}$	$T_{VJ} = 25^{\circ}C$		2	μs	
		$I_G = 0.5\text{ A}; di_G/dt = 0.5\text{ A}/\mu s$					
t_q	turn-off time	$V_R = 100\text{ V}; I_T = 200\text{ A}; V = \frac{2}{3} V_{DRM}$ $T_{VJ} = 125^{\circ}C$		150		μs	
		$di/dt = 10\text{ A}/\mu s$ $dv/dt = 20\text{ V}/\mu s$ $t_p = 200\text{ }\mu s$					



Package Y4				Ratings			
Symbol	Definition	Conditions	min.	typ.	max.	Unit	
I_{RMS}	RMS current	per terminal			300	A	
T_{VJ}	virtual junction temperature		-40		140	°C	
T_{op}	operation temperature		-40		125	°C	
T_{stg}	storage temperature		-40		125	°C	
Weight					150	g	
M_D	mounting torque		2.25		2.75	Nm	
M_T	terminal torque		4.5		5.5	Nm	
$d_{Spp/App}$	creepage distance on surface striking distance through air	terminal to terminal	14.0	10.0		mm	
$d_{Spb/Apb}$		terminal to backside	16.0	16.0		mm	
V_{ISOL}	isolation voltage	t = 1 second		3600		V	
		t = 1 minute	50/60 Hz, RMS; $I_{ISOL} \leq 1$ mA	3000		V	



Data Matrix: part no. (1-19), DC + PI (20-25), lot.no.# (26-31), blank (32), serial no.# (33-36)

Part description

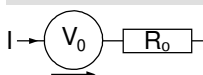
- M = Module
- C = Thyristor (SCR)
- M = Thyristor
- A = (up to 1800V)
- 200 = Current Rating [A]
- P = Phase leg
- 1800 = Reverse Voltage [V]
- YA = Y4-M6
- = Hyphen
- MI = with metal inserts

Ordering	Ordering Number	Marking on Product	Delivery Mode	Quantity	Code No.
Standard	MCMA200P1800YA-MI	MCMA200P1800YA-MI	Box	6	524802

Equivalent Circuits for Simulation

* on die level

$T_{VJ} = 140$ °C

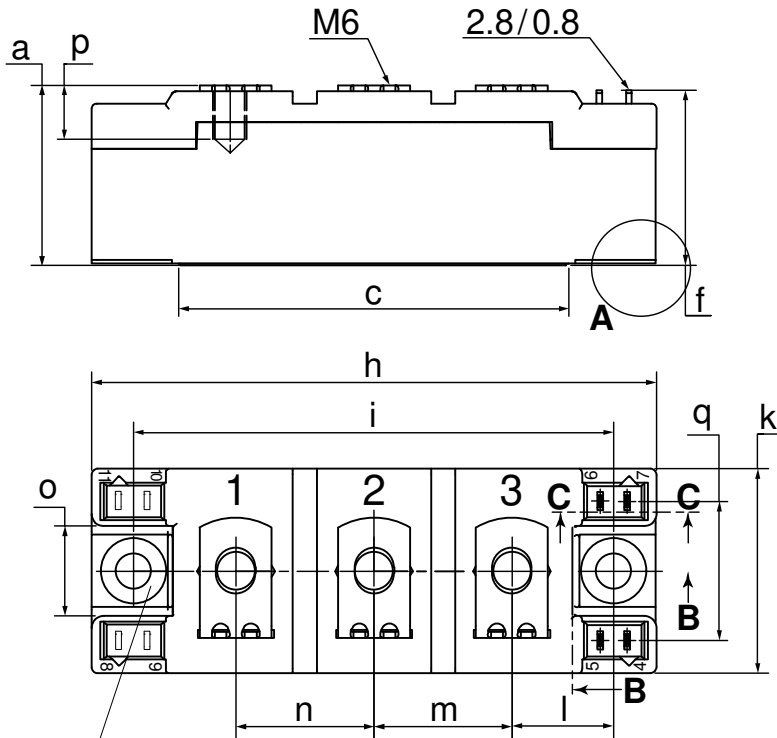


Thyristor

$V_{0\ max}$	threshold voltage	0.83	V
$R_{0\ max}$	slope resistance *	0.8	mΩ



Outlines Y4



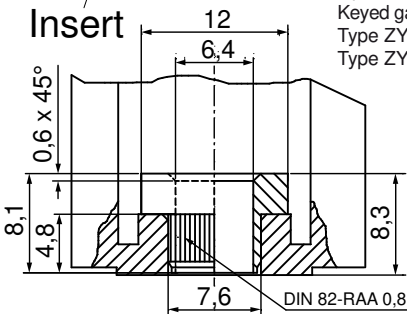
Dim.	MIN [mm]	MAX [mm]	MIN [inch]	MAX [inch]
a	30.0	30.6	1.181	1.205
b	typ. 0.25		typ. 0.010	
c	64.0	65.0	2.520	2.559
d	typ. 6.4		typ. 0.250	
e	4.9	5.1	0.193	0.201
f	28.6	29.2	1.126	1.150
g	7.3	7.7	0.287	0.303
h	93.5	94.5	3.681	3.720
i	79.5	80.5	3.130	3.169
j	4.8	5.2	0.189	0.205
k	33.4	34.0	1.315	1.339
l	16.7	17.3	0.657	0.681
m	22.7	23.3	0.894	0.917
n	22.7	23.3	0.894	0.917
o	14.0	15.0	0.551	0.591
p	typ. 10.5		typ. 0.413	
q	22.8	23.3	0.898	0.917
r	1.8	2.4	0.071	0.041

Optional accessories for modules

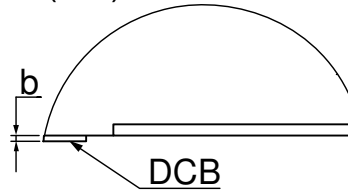
Keyed gate/cathode twin plugs with wire length = 350 mm, gate = white, cathode = red

Type ZY 180L (L = Left for pin pair 4/5)

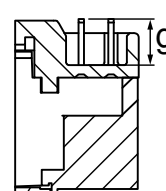
Type ZY 180R (R = Right for pin pair 6/7) } UL 758, style 3751



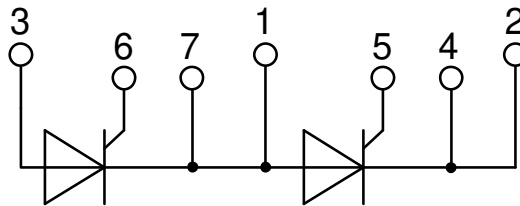
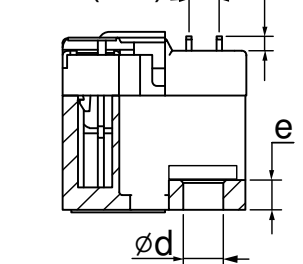
A (3:1)



C-C (1:1)



B-B (1:1)



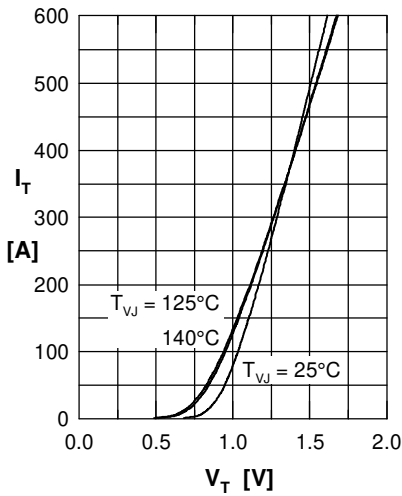
Thyristor


Fig. 1 Forward current vs. voltage drop per thyristor

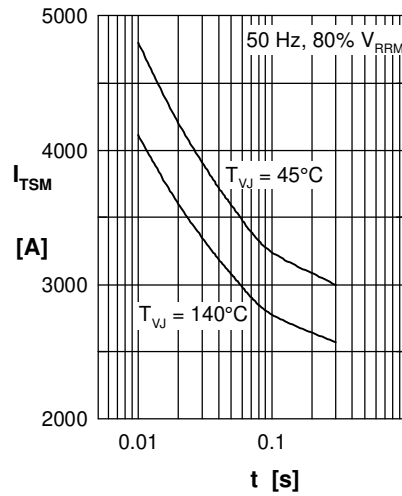


Fig. 2 Surge overload current vs. time per thyristor

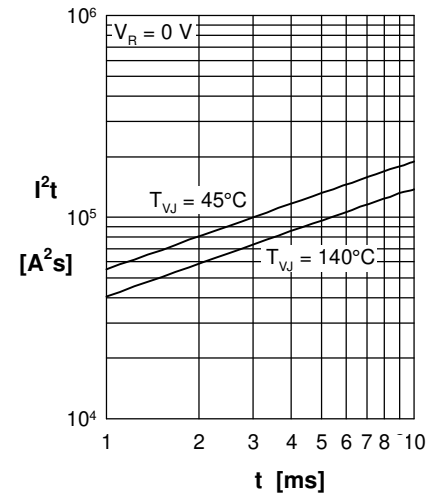
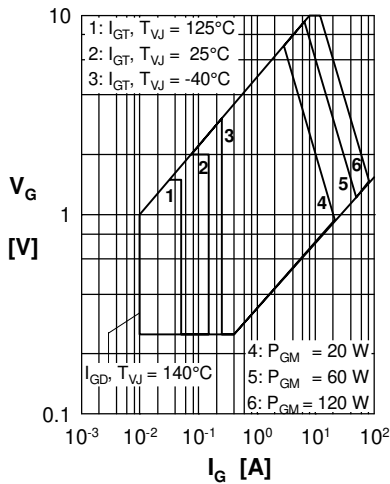

 Fig. 3 I^2t vs. time per thyristor


Fig. 4 Gate voltage & gate current

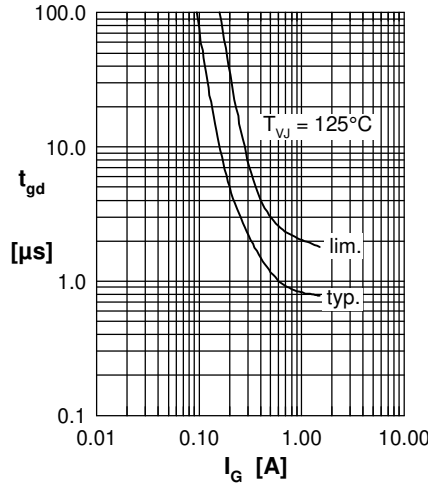
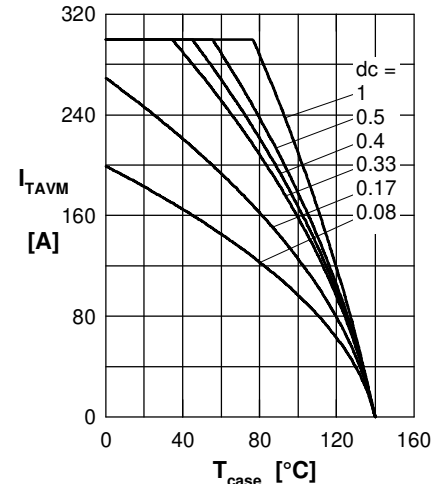

 Fig. 5 Gate controlled delay time t_{gd}


Fig. 6 Max. forward current vs. case temperature per thy.

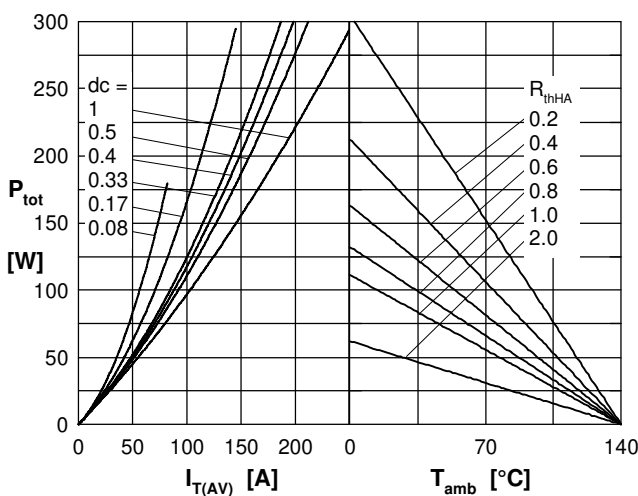


Fig. 7 Power dissipation vs. forward current and ambient temperature per thyristor

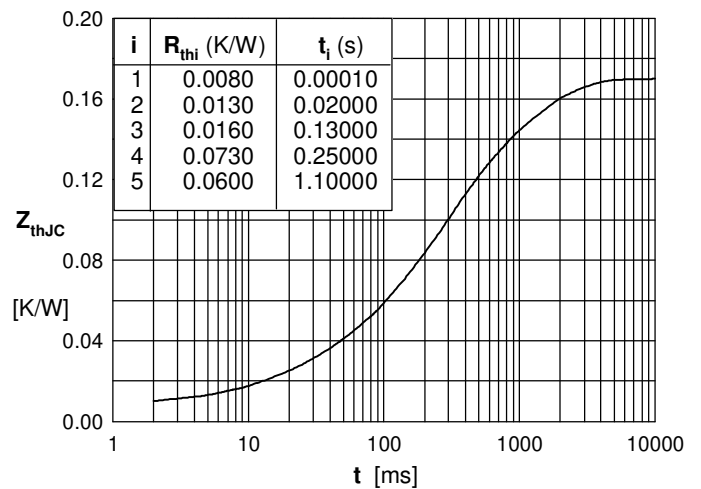


Fig. 8 Transient thermal impedance junction to case vs. time per thyristor