

Thyristor Module

$$V_{RRM} = 2 \times 1600 \text{ V}$$

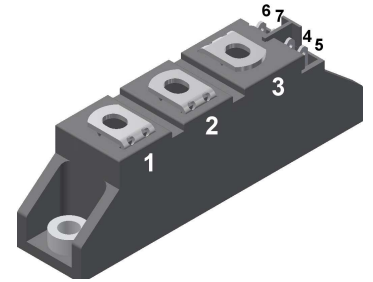
$$I_{TAV} = 140 \text{ A}$$

$$V_T = 1.28 \text{ V}$$


Phase leg

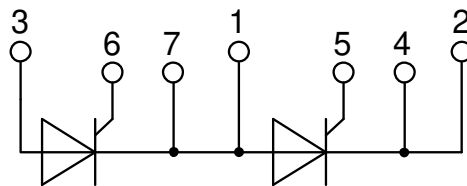
Part number

MCMA140P1600TA



Backside: isolated

 E72873



Features / Advantages:

- Thyristor for line frequency
- Planar passivated chip
- Long-term stability
- Direct Copper Bonded Al₂O₃-ceramic

Applications:

- Line rectifying 50/60 Hz
- Softstart AC motor control
- DC Motor control
- Power converter
- AC power control
- Lighting and temperature control

Package: TO-240AA

- Isolation Voltage: 4800 V~
- Industry standard outline
- RoHS compliant
- Soldering pins for PCB mounting
- Base plate: DCB ceramic
- Reduced weight
- Advanced power cycling

Disclaimer Notice

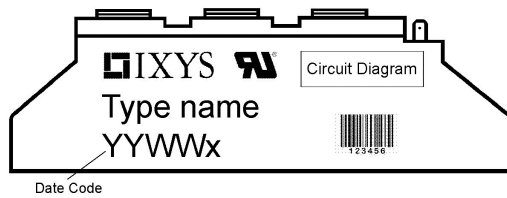
Information furnished is believed to be accurate and reliable. However, users should independently evaluate the suitability of and test each product selected for their own applications. Littelfuse products are not designed for, and may not be used in, all applications. Read complete Disclaimer Notice at www.littelfuse.com/disclaimer-electronics.



Thyristor			Ratings			
Symbol	Definition	Conditions	min.	typ.	max.	Unit
$V_{RSM/DSM}$	max. non-repetitive reverse/forward blocking voltage	$T_{VJ} = 25^{\circ}C$			1700	V
$V_{RRM/DRM}$	max. repetitive reverse/forward blocking voltage	$T_{VJ} = 25^{\circ}C$			1600	V
I_{RD}	reverse current, drain current	$V_{R/D} = 1600 V$	$T_{VJ} = 25^{\circ}C$		100	μA
		$V_{R/D} = 1600 V$	$T_{VJ} = 140^{\circ}C$		10	mA
V_T	forward voltage drop	$I_T = 150 A$	$T_{VJ} = 25^{\circ}C$		1.29	V
		$I_T = 300 A$			1.63	V
		$I_T = 150 A$	$T_{VJ} = 125^{\circ}C$		1.28	V
		$I_T = 300 A$			1.70	V
I_{TAV}	average forward current	$T_C = 85^{\circ}C$	$T_{VJ} = 140^{\circ}C$		140	A
$I_{T(RMS)}$	RMS forward current	180° sine			220	A
V_{T0}	threshold voltage	} for power loss calculation only	$T_{VJ} = 140^{\circ}C$		0.85	V
r_T	slope resistance				2.8	m Ω
R_{thJC}	thermal resistance junction to case				0.22	K/W
R_{thCH}	thermal resistance case to heatsink			0.2		K/W
P_{tot}	total power dissipation		$T_C = 25^{\circ}C$		520	W
I_{TSM}	max. forward surge current	$t = 10 \text{ ms}; (50 \text{ Hz}), \text{ sine}$	$T_{VJ} = 45^{\circ}C$		2.40	kA
		$t = 8,3 \text{ ms}; (60 \text{ Hz}), \text{ sine}$	$V_R = 0 V$		2.59	kA
		$t = 10 \text{ ms}; (50 \text{ Hz}), \text{ sine}$	$T_{VJ} = 140^{\circ}C$		2.04	kA
		$t = 8,3 \text{ ms}; (60 \text{ Hz}), \text{ sine}$	$V_R = 0 V$		2.21	kA
I^2t	value for fusing	$t = 10 \text{ ms}; (50 \text{ Hz}), \text{ sine}$	$T_{VJ} = 45^{\circ}C$		28.8	kA ² s
		$t = 8,3 \text{ ms}; (60 \text{ Hz}), \text{ sine}$	$V_R = 0 V$		27.9	kA ² s
		$t = 10 \text{ ms}; (50 \text{ Hz}), \text{ sine}$	$T_{VJ} = 140^{\circ}C$		20.8	kA ² s
		$t = 8,3 \text{ ms}; (60 \text{ Hz}), \text{ sine}$	$V_R = 0 V$		20.2	kA ² s
C_J	junction capacitance	$V_R = 400 V \quad f = 1 \text{ MHz}$	$T_{VJ} = 25^{\circ}C$		119	pF
P_{GM}	max. gate power dissipation	$t_p = 30 \mu s$	$T_C = 140^{\circ}C$		10	W
		$t_p = 300 \mu s$			5	W
P_{GAV}	average gate power dissipation				0.5	W
$(di/dt)_{cr}$	critical rate of rise of current	$T_{VJ} = 140^{\circ}C; f = 50 \text{ Hz}$	repetitive, $I_T = 450 A$		150	A/ μs
		$t_p = 200 \mu s; di_G/dt = 0.45 A/\mu s;$ $I_G = 0.45 A; V = \frac{2}{3} V_{DRM}$	non-repet., $I_T = 150 A$		500	A/ μs
$(dv/dt)_{cr}$	critical rate of rise of voltage	$V = \frac{2}{3} V_{DRM}$ $R_{GK} = \infty; \text{ method 1 (linear voltage rise)}$	$T_{VJ} = 140^{\circ}C$		1000	V/ μs
V_{GT}	gate trigger voltage	$V_D = 6 V$	$T_{VJ} = 25^{\circ}C$		1.5	V
			$T_{VJ} = -40^{\circ}C$		1.6	V
I_{GT}	gate trigger current	$V_D = 6 V$	$T_{VJ} = 25^{\circ}C$		150	mA
			$T_{VJ} = -40^{\circ}C$		200	mA
V_{GD}	gate non-trigger voltage	$V_D = \frac{2}{3} V_{DRM}$	$T_{VJ} = 140^{\circ}C$		0.2	V
I_{GD}	gate non-trigger current				10	mA
I_L	latching current	$t_p = 10 \mu s$	$T_{VJ} = 25^{\circ}C$		200	mA
		$I_G = 0.45 A; di_G/dt = 0.45 A/\mu s$				
I_H	holding current	$V_D = 6 V \quad R_{GK} = \infty$	$T_{VJ} = 25^{\circ}C$		200	mA
t_{gd}	gate controlled delay time	$V_D = \frac{1}{2} V_{DRM}$ $I_G = 0.45 A; di_G/dt = 0.45 A/\mu s$	$T_{VJ} = 25^{\circ}C$		2	μs
t_q	turn-off time	$V_R = 100 V; I_T = 150 A; V = \frac{2}{3} V_{DRM}$ $di/dt = 10 A/\mu s \quad dv/dt = 20 V/\mu s \quad t_p = 200 \mu s$	$T_{VJ} = 125^{\circ}C$		185	μs



Package TO-240AA				Ratings			
Symbol	Definition	Conditions	min.	typ.	max.	Unit	
I_{RMS}	RMS current	per terminal			200	A	
T_{VJ}	virtual junction temperature		-40		140	°C	
T_{op}	operation temperature		-40		125	°C	
T_{stg}	storage temperature		-40		125	°C	
Weight					81	g	
M_D	mounting torque		2.5		4	Nm	
M_T	terminal torque		2.5		4	Nm	
$d_{Spp/App}$	creepage distance on surface striking distance through air	terminal to terminal	13.0	9.7		mm	
$d_{Spb/Apb}$		terminal to backside	16.0	16.0		mm	
V_{ISOL}	isolation voltage	t = 1 second	50/60 Hz, RMS; $I_{ISOL} \leq 1$ mA		4800	V	
		t = 1 minute			4000	V	



Part description

- M = Module
- C = Thyristor (SCR)
- M = Thyristor
- A = (up to 1800V)
- 140 = Current Rating [A]
- P = Phase leg
- 1600 = Reverse Voltage [V]
- TA = TO-240AA-1B

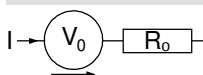
Ordering	Ordering Number	Marking on Product	Delivery Mode	Quantity	Code No.
Standard	MCMA140P1600TA	MCMA140P1600TA	Box	36	509341

Similar Part	Package	Voltage class
MCMA140P1800TA	TO-240AA-1B	1800

Equivalent Circuits for Simulation

* on die level

$T_{VJ} = 140^{\circ}\text{C}$

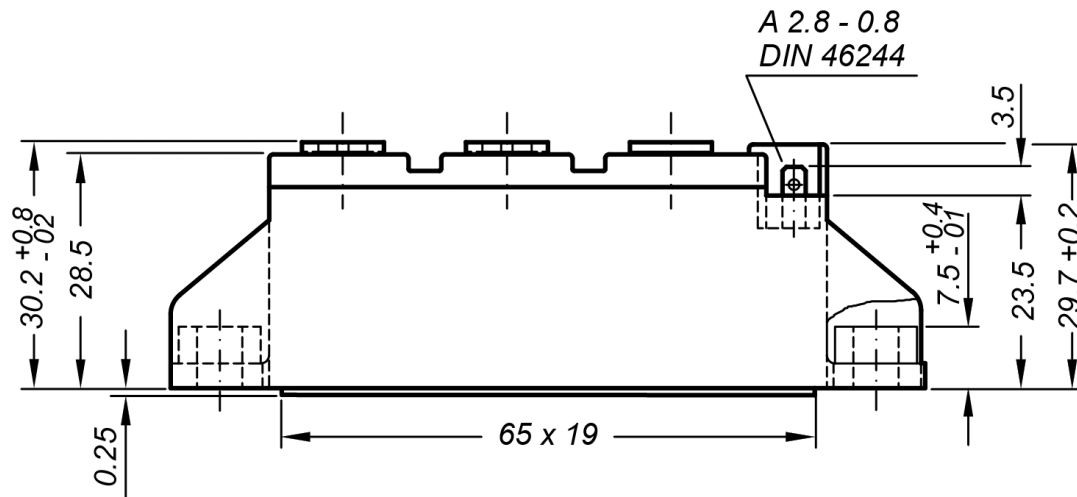


Thyristor

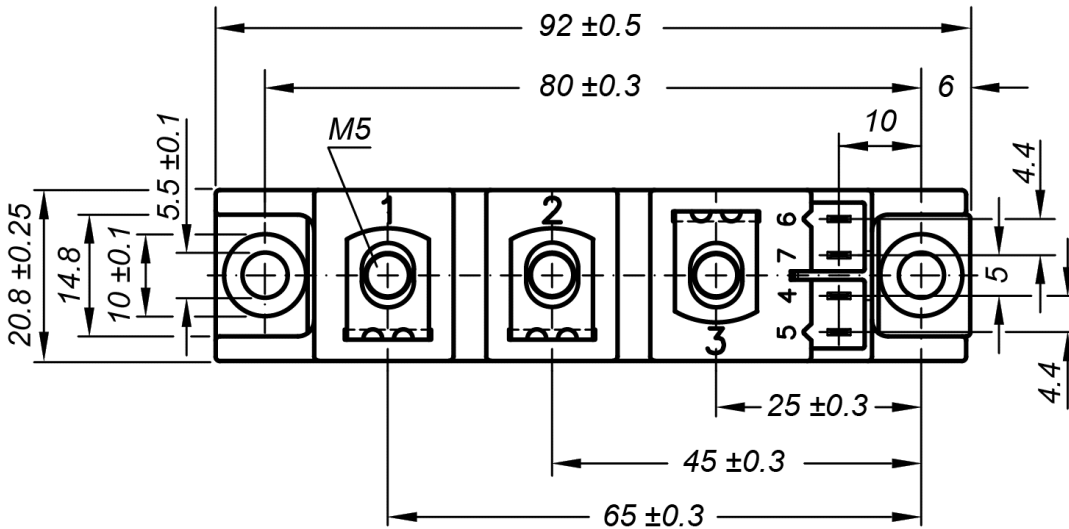
$V_{0\ max}$	threshold voltage	0.85	V
$R_{0\ max}$	slope resistance *	1.6	mΩ



Outlines TO-240AA



General tolerance: DIN ISO 2768 class „c“



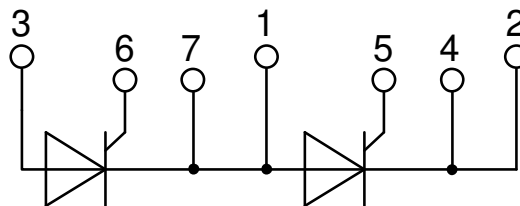
Optional accessories for modules

Keyed gate/cathode twin plugs with wire length = 350 mm, gate = white, cathode = red

Type ZY 200L (L = Left for pin pair 4/5)

Type ZY 200R (R = Right for pin pair 6/7)

UL 758, style 3751



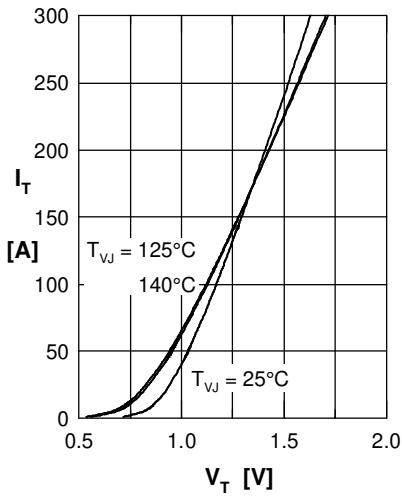
Thyristor


Fig. 1 Forward characteristics

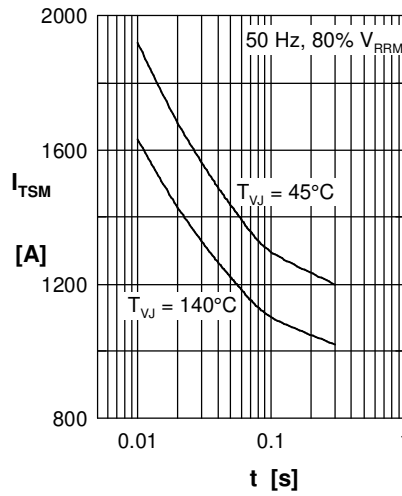
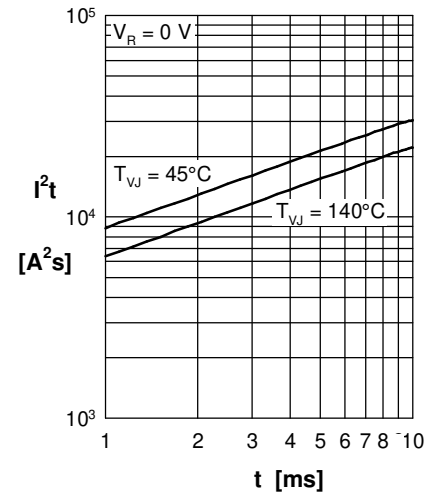
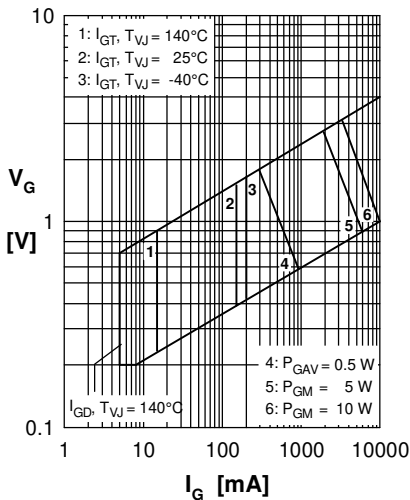

 Fig. 2 Surge overload current
 I_{TSM} : crest value, t : duration

 Fig. 3 I^2t versus time (1-10 s)


Fig. 4 Gate voltage & gate current

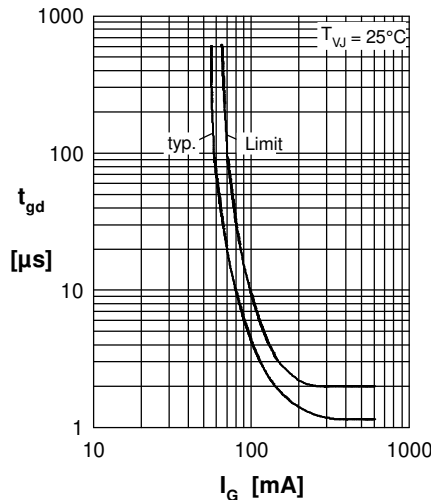
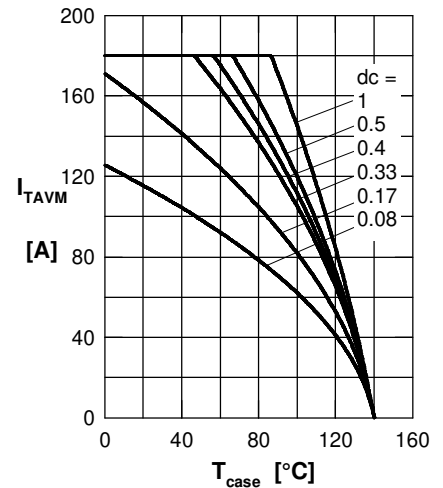

 Fig. 5 Gate controlled delay time t_{gd}


Fig. 6 Max. forward current at case temperature

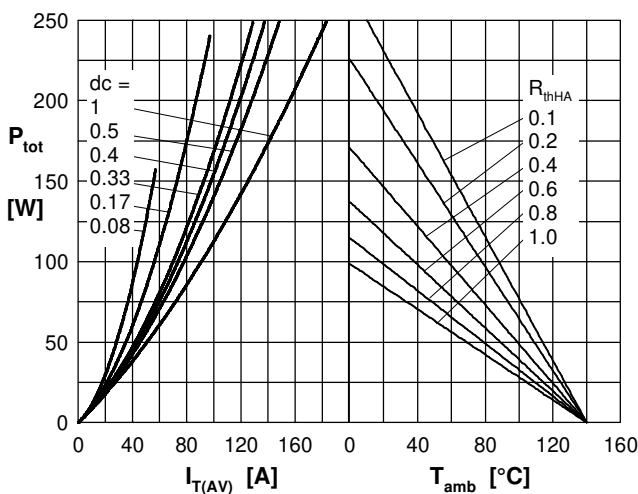
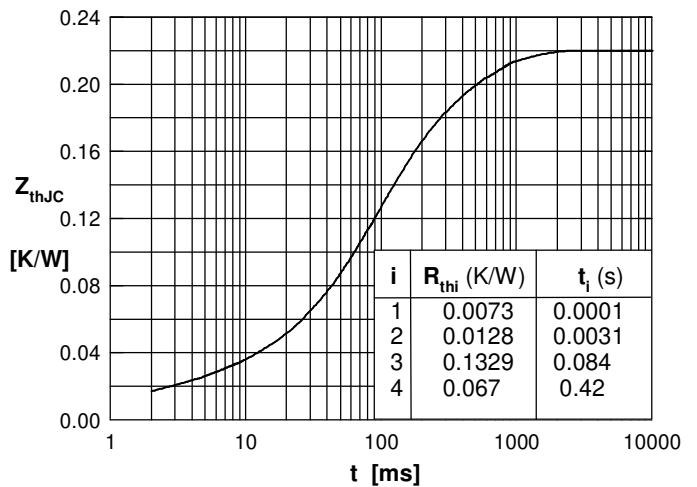

 Fig. 7a Power dissipation versus direct output current
 Fig. 7b and ambient temperature


Fig. 8 Transient thermal impedance junction to case