

# Thyristor \ Diode Module

$$V_{RRM} = 2 \times 1200 \text{ V}$$

$$I_{TAV} = 130 \text{ A}$$

$$V_T = 1.08 \text{ V}$$

Phase leg

Part number

**MCD132-12io1**



Backside: isolated

 E72873



### Features / Advantages:

- Thyristor for line frequency
- Planar passivated chip
- Long-term stability
- Direct Copper Bonded Al<sub>2</sub>O<sub>3</sub>-ceramic

### Applications:

- Line rectifying 50/60 Hz
- Softstart AC motor control
- DC Motor control
- Power converter
- AC power control
- Lighting and temperature control

### Package: Y4

- Isolation Voltage: 3600 V~
- Industry standard outline
- RoHS compliant
- Soldering pins for PCB mounting
- Base plate: DCB ceramic
- Reduced weight
- Advanced power cycling

### Disclaimer Notice

Information furnished is believed to be accurate and reliable. However, users should independently evaluate the suitability of and test each product selected for their own applications. Littelfuse products are not designed for, and may not be used in, all applications. Read complete Disclaimer Notice at [www.littelfuse.com/disclaimer-electronics](http://www.littelfuse.com/disclaimer-electronics).



Rectifier			Ratings			
Symbol	Definition	Conditions	min.	typ.	max.	Unit
$V_{RSM/DSM}$	max. non-repetitive reverse/forward blocking voltage	$T_{VJ} = 25^{\circ}C$			1300	V
$V_{RRM/DRM}$	max. repetitive reverse/forward blocking voltage	$T_{VJ} = 25^{\circ}C$			1200	V
$I_{RD}$	reverse current, drain current	$V_{R/D} = 1200 V$	$T_{VJ} = 25^{\circ}C$		200	$\mu A$
		$V_{R/D} = 1200 V$	$T_{VJ} = 125^{\circ}C$		10	mA
$V_T$	forward voltage drop	$I_T = 150 A$	$T_{VJ} = 25^{\circ}C$		1.14	V
		$I_T = 300 A$			1.36	V
		$I_T = 150 A$	$T_{VJ} = 125^{\circ}C$		1.08	V
		$I_T = 300 A$			1.36	V
$I_{TAV}$	average forward current	$T_C = 85^{\circ}C$	$T_{VJ} = 125^{\circ}C$		130	A
$I_{T(RMS)}$	RMS forward current	180° sine			300	A
$V_{T0}$	threshold voltage	} for power loss calculation only	$T_{VJ} = 125^{\circ}C$		0.80	V
$r_T$	slope resistance				1.5	m $\Omega$
$R_{thJC}$	thermal resistance junction to case				0.23	K/W
$R_{thCH}$	thermal resistance case to heatsink			0.1		K/W
$P_{tot}$	total power dissipation		$T_C = 25^{\circ}C$		435	W
$I_{TSM}$	max. forward surge current	$t = 10 \text{ ms}; (50 \text{ Hz}), \text{ sine}$	$T_{VJ} = 45^{\circ}C$		4.75	kA
		$t = 8,3 \text{ ms}; (60 \text{ Hz}), \text{ sine}$	$V_R = 0 V$		5.13	kA
		$t = 10 \text{ ms}; (50 \text{ Hz}), \text{ sine}$	$T_{VJ} = 125^{\circ}C$		4.04	kA
		$t = 8,3 \text{ ms}; (60 \text{ Hz}), \text{ sine}$	$V_R = 0 V$		4.36	kA
$I^2t$	value for fusing	$t = 10 \text{ ms}; (50 \text{ Hz}), \text{ sine}$	$T_{VJ} = 45^{\circ}C$		112.8	kA <sup>2</sup> s
		$t = 8,3 \text{ ms}; (60 \text{ Hz}), \text{ sine}$	$V_R = 0 V$		109.5	kA <sup>2</sup> s
		$t = 10 \text{ ms}; (50 \text{ Hz}), \text{ sine}$	$T_{VJ} = 125^{\circ}C$		81.6	kA <sup>2</sup> s
		$t = 8,3 \text{ ms}; (60 \text{ Hz}), \text{ sine}$	$V_R = 0 V$		79.1	kA <sup>2</sup> s
$C_J$	junction capacitance	$V_R = 400 V \quad f = 1 \text{ MHz}$	$T_{VJ} = 25^{\circ}C$		211	pF
$P_{GM}$	max. gate power dissipation	$t_p = 30 \mu s$	$T_C = 125^{\circ}C$		120	W
		$t_p = 500 \mu s$			60	W
$P_{GAV}$	average gate power dissipation				8	W
$(di/dt)_{cr}$	critical rate of rise of current	$T_{VJ} = 125^{\circ}C; f = 50 \text{ Hz}$	repetitive, $I_T = 500 A$		150	A/ $\mu s$
		$t_p = 200 \mu s; di_G/dt = 0.5 A/\mu s;$	non-repet., $I_T = 160 A$		500	A/ $\mu s$
$(dv/dt)_{cr}$	critical rate of rise of voltage	$V = \frac{2}{3} V_{DRM}$	$T_{VJ} = 125^{\circ}C$		1000	V/ $\mu s$
		$R_{GK} = \infty; \text{method 1 (linear voltage rise)}$				
$V_{GT}$	gate trigger voltage	$V_D = 6 V$	$T_{VJ} = 25^{\circ}C$		2.5	V
			$T_{VJ} = -40^{\circ}C$		2.6	V
$I_{GT}$	gate trigger current	$V_D = 6 V$	$T_{VJ} = 25^{\circ}C$		150	mA
			$T_{VJ} = -40^{\circ}C$		200	mA
$V_{GD}$	gate non-trigger voltage	$V_D = \frac{2}{3} V_{DRM}$	$T_{VJ} = 125^{\circ}C$		0.2	V
$I_{GD}$	gate non-trigger current				10	mA
$I_L$	latching current	$t_p = 30 \mu s$	$T_{VJ} = 25^{\circ}C$		300	mA
		$I_G = 0.5 A; di_G/dt = 0.5 A/\mu s$				
$I_H$	holding current	$V_D = 6 V \quad R_{GK} = \infty$	$T_{VJ} = 25^{\circ}C$		200	mA
$t_{gd}$	gate controlled delay time	$V_D = \frac{1}{2} V_{DRM}$	$T_{VJ} = 25^{\circ}C$		2	$\mu s$
		$I_G = 0.5 A; di_G/dt = 0.5 A/\mu s$				
$t_q$	turn-off time	$V_R = 100 V; I_T = 160 A; V = \frac{2}{3} V_{DRM}$	$T_{VJ} = 100^{\circ}C$		150	$\mu s$
		$di/dt = 10 A/\mu s \quad dv/dt = 20 V/\mu s \quad t_p = 200 \mu s$				



Package Y4				Ratings			
Symbol	Definition	Conditions	min.	typ.	max.	Unit	
$I_{RMS}$	RMS current	per terminal			300	A	
$T_{VJ}$	virtual junction temperature		-40		125	°C	
$T_{op}$	operation temperature		-40		100	°C	
$T_{stg}$	storage temperature		-40		125	°C	
<b>Weight</b>				150		g	
$M_D$	mounting torque		2.25		2.75	Nm	
$M_T$	terminal torque		4.5		5.5	Nm	
$d_{Spp/App}$	creepage distance on surface   striking distance through air	terminal to terminal	14.0	10.0		mm	
$d_{Spb/Apb}$		terminal to backside	16.0	16.0		mm	
$V_{ISOL}$	isolation voltage	t = 1 second			3600	V	
		t = 1 minute	50/60 Hz, RMS; $I_{ISOL} \leq 1$ mA		3000	V	



Data Matrix: part no. (1-19), DC + PI (20-25), lot.no.# (26-31), blank (32), serial no.# (33-36)

Ordering	Ordering Number	Marking on Product	Delivery Mode	Quantity	Code No.
Standard	MCD132-12io1	MCD132-12io1	Box	6	430609

**Equivalent Circuits for Simulation**

\* on die level

$T_{VJ} = 125^{\circ}\text{C}$



**Thyristor**

$V_{0\ max}$	threshold voltage	0.8	V
$R_{0\ max}$	slope resistance *	0.8	mΩ



**Outlines Y4**

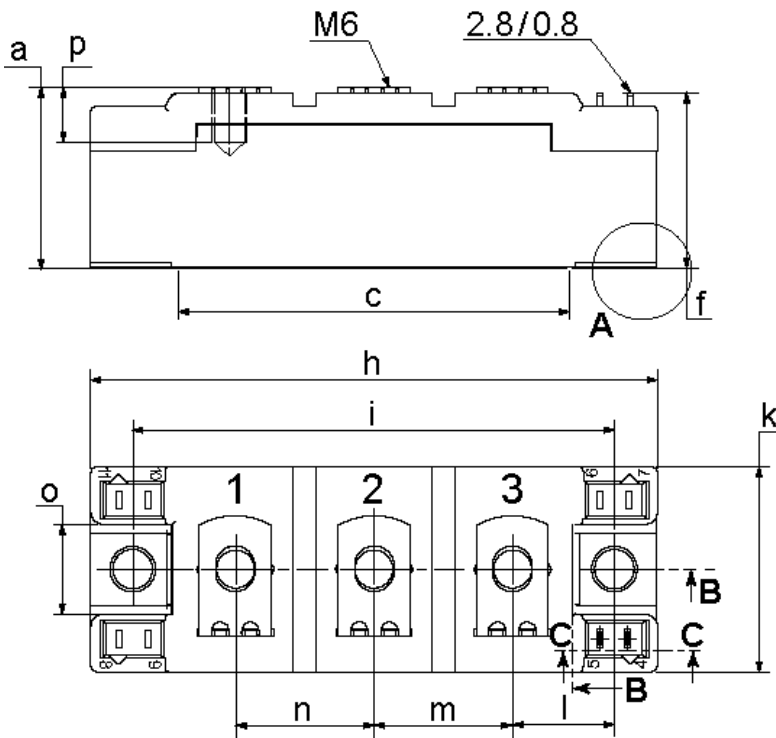

Dim.	MIN [mm]	MAX [mm]	MIN [inch]	MAX [inch]
a	30.0	30.6	1.181	1.205
b	typ. 0.25		typ. 0.010	
c	64.0	65.0	2.520	2.559
d	6.5	7.0	0.256	0.275
e	4.9	5.1	0.193	0.201
f	28.6	29.2	1.126	1.150
g	7.3	7.7	0.287	0.303
h	93.5	94.5	3.681	3.720
i	79.5	80.5	3.130	3.169
j	4.8	5.2	0.189	0.205
k	33.4	34.0	1.315	1.339
l	16.7	17.3	0.657	0.681
m	22.7	23.3	0.894	0.917
n	22.7	23.3	0.894	0.917
o	14.0	15.0	0.551	0.591
p	typ. 10.5		typ. 0.413	
r	1.8	2.4	0.071	0.041

Optional accessories for modules  
Keyed gate/cathode twin plugs with wire length = 350 mm, gate = white, cathode = red  
Type ZY 180L (L = Left for pin pair 4/5) UL 758, style 3751

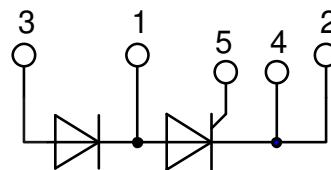
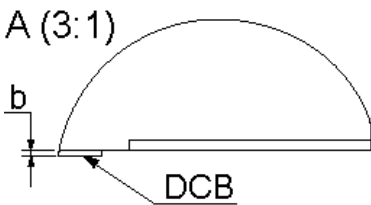

**Thyristor**

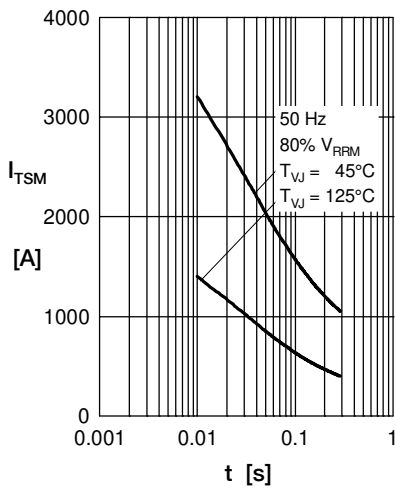

Fig. 1 Surge overload current  $I_{TSM}$ ,  $I_{FSM}$ : Crest value,  $t$ : duration

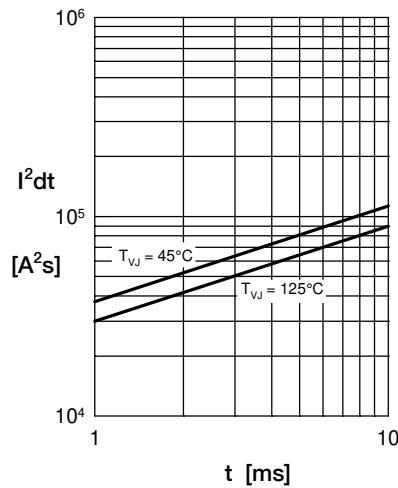

Fig. 2  $I^2t$  versus time (1-10 ms)

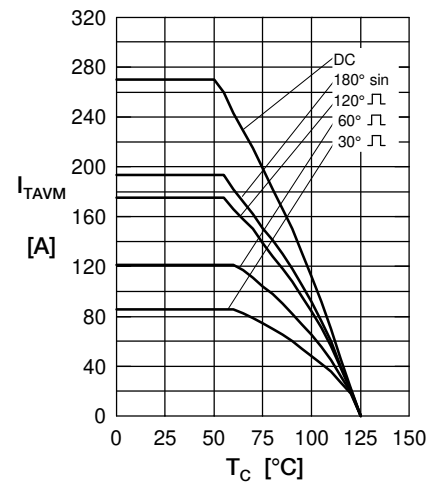

Fig. 3 Max. forward current at case temperature

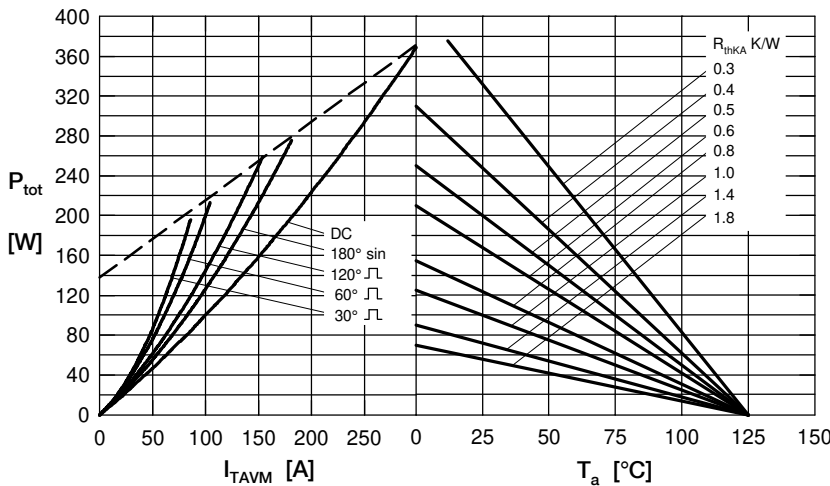

Fig. 4 Power dissipation vs. on-state current & ambient temperature (per thyristor or diode)

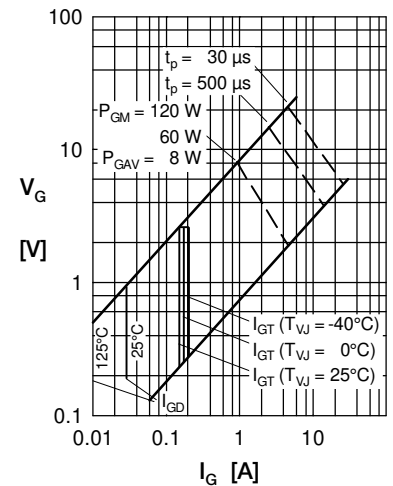

Fig. 5 Gate trigger characteristics



Fig. 6 Three phase rectifier bridge: Power dissipation versus direct output current and ambient temperature

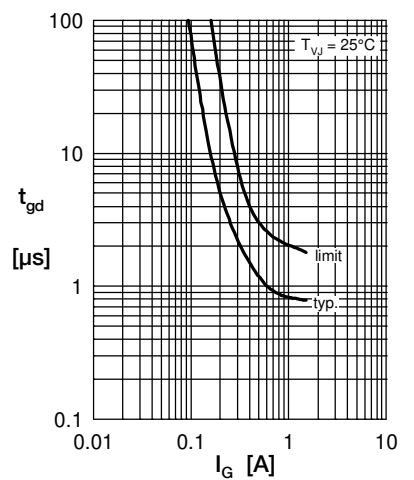

Fig. 7 Gate trigger delay time



**Rectifier**

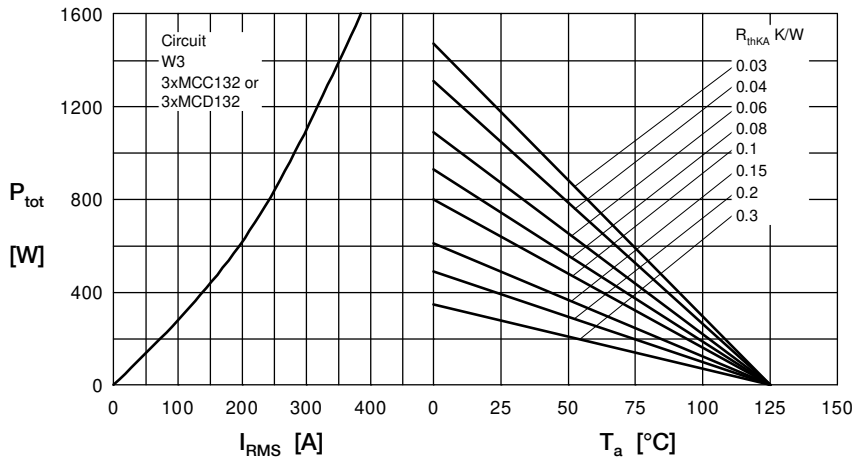

Fig. 8 Three phase AC-controller: Power dissipation versus RMS output current and ambient temperature

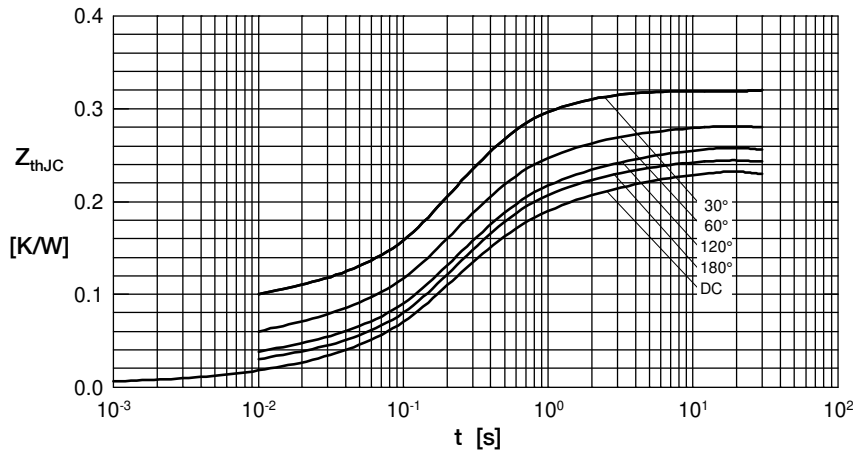

Fig. 9 Transient thermal impedance junction to case (per thyristor/diode)

$R_{thJC}$  for various conduction angles  $d$ :

$d$	$R_{thJC}$ [K/W]
DC	0.230
180°	0.244
120°	0.255
60°	0.283
30°	0.321

Constants for  $Z_{thJC}$  calculation:

$i$	$R_{thi}$ [K/W]	$t_i$ [s]
1	0.0095	0.001
2	0.0175	0.065
3	0.2030	0.400

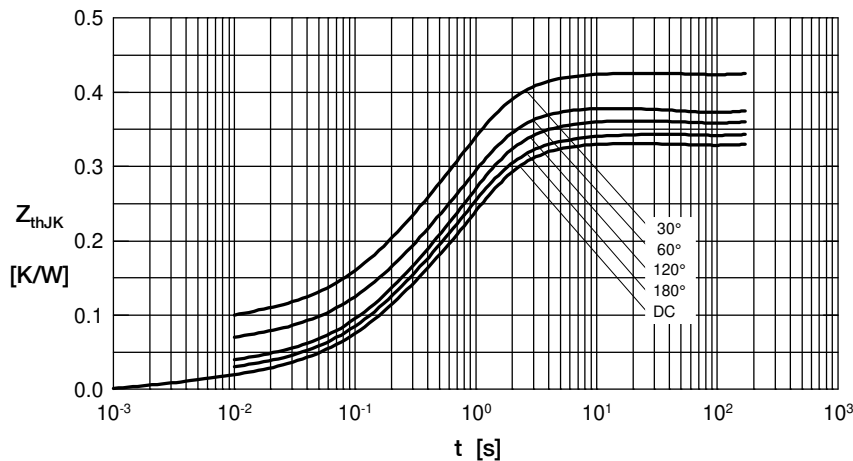

Fig. 10 Transient thermal impedance junction to heatsink (per thyristor/diode)

$R_{thJK}$  for various conduction angles  $d$ :

$d$	$R_{thJK}$ [K/W]
DC	0.330
180°	0.344
120°	0.355
60°	0.383
30°	0.421

Constants for  $Z_{thJK}$  calculation:

$i$	$R_{thi}$ [K/W]	$t_i$ [s]
1	0.0095	0.001
2	0.0175	0.065
3	0.2030	0.400
4	0.1000	1.290