

Thyristor Module

$$V_{RRM} = 2 \times 1800 \text{ V}$$

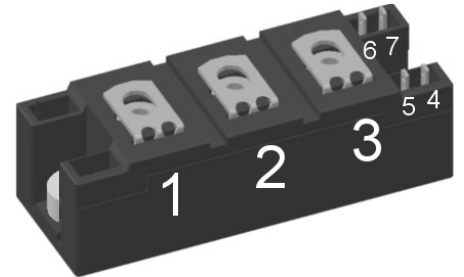
$$I_{TAV} = 130 \text{ A}$$

$$V_T = 1.08 \text{ V}$$


Phase leg

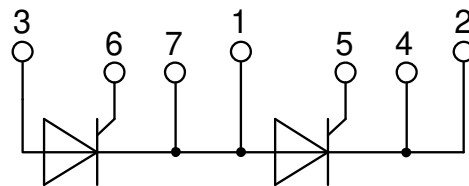
Part number

MCC132-18io1B



Backside: isolated

 E72873



Features / Advantages:

- Thyristor for line frequency
- Planar passivated chip
- Long-term stability
- Direct Copper Bonded Al₂O₃-ceramic

Applications:

- Line rectifying 50/60 Hz
- Softstart AC motor control
- DC Motor control
- Power converter
- AC power control
- Lighting and temperature control

Package: Y4

- Isolation Voltage: 3600 V~
- Industry standard outline
- RoHS compliant
- Soldering pins for PCB mounting
- Base plate: DCB ceramic
- Reduced weight
- Advanced power cycling

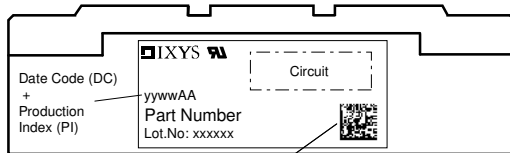
Disclaimer Notice

Information furnished is believed to be accurate and reliable. However, users should independently evaluate the suitability of and test each product selected for their own applications. Littelfuse products are not designed for, and may not be used in, all applications. Read complete Disclaimer Notice at www.littelfuse.com/disclaimer-electronics.

Thyristor			Ratings			
Symbol	Definition	Conditions	min.	typ.	max.	Unit
$V_{RSM/DSM}$	max. non-repetitive reverse/forward blocking voltage	$T_{VJ} = 25^{\circ}C$			1900	V
$V_{RRM/DRM}$	max. repetitive reverse/forward blocking voltage	$T_{VJ} = 25^{\circ}C$			1800	V
I_{RD}	reverse current, drain current	$V_{R/D} = 1800 V$	$T_{VJ} = 25^{\circ}C$		200	μA
		$V_{R/D} = 1800 V$	$T_{VJ} = 125^{\circ}C$		10	mA
V_T	forward voltage drop	$I_T = 150 A$	$T_{VJ} = 25^{\circ}C$		1.14	V
		$I_T = 300 A$			1.36	V
		$I_T = 150 A$	$T_{VJ} = 125^{\circ}C$		1.08	V
		$I_T = 300 A$			1.36	V
I_{TAV}	average forward current	$T_C = 85^{\circ}C$	$T_{VJ} = 125^{\circ}C$		130	A
$I_{T(RMS)}$	RMS forward current	180° sine			300	A
V_{T0}	threshold voltage	} for power loss calculation only	$T_{VJ} = 125^{\circ}C$		0.80	V
r_T	slope resistance				1.5	m Ω
R_{thJC}	thermal resistance junction to case				0.23	K/W
R_{thCH}	thermal resistance case to heatsink			0.1		K/W
P_{tot}	total power dissipation		$T_C = 25^{\circ}C$		435	W
I_{TSM}	max. forward surge current	$t = 10 ms$; (50 Hz), sine	$T_{VJ} = 45^{\circ}C$		4.75	kA
		$t = 8,3 ms$; (60 Hz), sine	$V_R = 0 V$		5.13	kA
		$t = 10 ms$; (50 Hz), sine	$T_{VJ} = 125^{\circ}C$		4.04	kA
		$t = 8,3 ms$; (60 Hz), sine	$V_R = 0 V$		4.36	kA
I^2t	value for fusing	$t = 10 ms$; (50 Hz), sine	$T_{VJ} = 45^{\circ}C$		112.8	kA ² s
		$t = 8,3 ms$; (60 Hz), sine	$V_R = 0 V$		109.5	kA ² s
		$t = 10 ms$; (50 Hz), sine	$T_{VJ} = 125^{\circ}C$		81.6	kA ² s
		$t = 8,3 ms$; (60 Hz), sine	$V_R = 0 V$		79.1	kA ² s
C_J	junction capacitance	$V_R = 400 V$ $f = 1 MHz$	$T_{VJ} = 25^{\circ}C$	211		pF
P_{GM}	max. gate power dissipation	$t_p = 30 \mu s$	$T_C = 125^{\circ}C$		120	W
		$t_p = 500 \mu s$			60	W
P_{GAV}	average gate power dissipation				8	W
$(di/dt)_{cr}$	critical rate of rise of current	$T_{VJ} = 125^{\circ}C$; $f = 50 Hz$ repetitive, $I_T = 500 A$			150	A/ μs
		$t_p = 200 \mu s$; $di_G/dt = 0.5 A/\mu s$; $I_G = 0.5 A$; $V = \frac{2}{3} V_{DRM}$ non-repet., $I_T = 160 A$			500	A/ μs
$(dv/dt)_{cr}$	critical rate of rise of voltage	$V = \frac{2}{3} V_{DRM}$ $R_{GK} = \infty$; method 1 (linear voltage rise)	$T_{VJ} = 125^{\circ}C$		1000	V/ μs
V_{GT}	gate trigger voltage	$V_D = 6 V$	$T_{VJ} = 25^{\circ}C$		2.5	V
			$T_{VJ} = -40^{\circ}C$		2.6	V
I_{GT}	gate trigger current	$V_D = 6 V$	$T_{VJ} = 25^{\circ}C$		150	mA
			$T_{VJ} = -40^{\circ}C$		200	mA
V_{GD}	gate non-trigger voltage	$V_D = \frac{2}{3} V_{DRM}$	$T_{VJ} = 125^{\circ}C$		0.2	V
I_{GD}	gate non-trigger current				10	mA
I_L	latching current	$t_p = 30 \mu s$	$T_{VJ} = 25^{\circ}C$		300	mA
		$I_G = 0.5 A$; $di_G/dt = 0.5 A/\mu s$				
I_H	holding current	$V_D = 6 V$ $R_{GK} = \infty$	$T_{VJ} = 25^{\circ}C$		200	mA
t_{gd}	gate controlled delay time	$V_D = \frac{1}{2} V_{DRM}$	$T_{VJ} = 25^{\circ}C$		2	μs
		$I_G = 0.5 A$; $di_G/dt = 0.5 A/\mu s$				
t_q	turn-off time	$V_R = 100 V$; $I_T = 160 A$; $V = \frac{2}{3} V_{DRM}$ $di/dt = 10 A/\mu s$ $dv/dt = 20 V/\mu s$ $t_p = 200 \mu s$	$T_{VJ} = 100^{\circ}C$	150		μs



Package Y4				Ratings			
Symbol	Definition	Conditions	min.	typ.	max.	Unit	
I_{RMS}	RMS current	per terminal			300	A	
T_{VJ}	virtual junction temperature		-40		125	°C	
T_{op}	operation temperature		-40		100	°C	
T_{stg}	storage temperature		-40		125	°C	
Weight					150	g	
M_D	mounting torque		2.25		2.75	Nm	
M_T	terminal torque		4.5		5.5	Nm	
$d_{Spp/App}$	creepage distance on surface striking distance through air	terminal to terminal	14.0	10.0		mm	
$d_{Spb/Apb}$		terminal to backside	16.0	16.0		mm	
V_{ISOL}	isolation voltage	t = 1 second			3600	V	
		t = 1 minute	50/60 Hz, RMS; $I_{ISOL} \leq 1$ mA		3000	V	



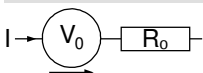
Data Matrix: part no. (1-19), DC + PI (20-25), lot.no.# (26-31), blank (32), serial no.# (33-36)

Ordering	Ordering Number	Marking on Product	Delivery Mode	Quantity	Code No.
Standard	MCC132-18io1B	MCC132-18io1B	Box	6	505025

Equivalent Circuits for Simulation

* on die level

$T_{VJ} = 125$ °C

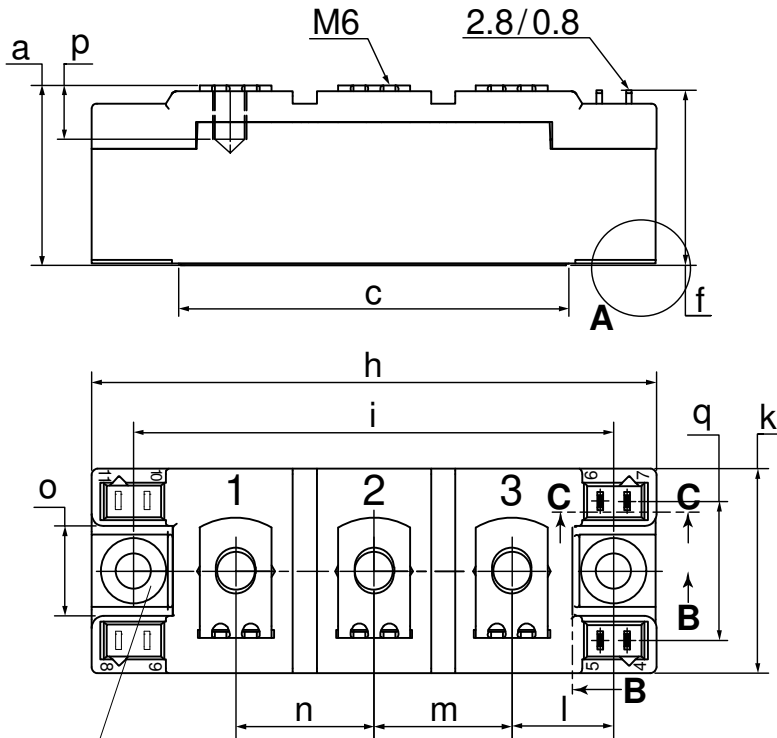


Thyristor

$V_{0 \max}$	threshold voltage	0.8	V
$R_{0 \max}$	slope resistance *	0.8	mΩ



Outlines Y4



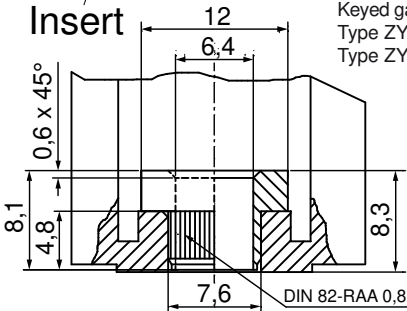
Dim.	MIN [mm]	MAX [mm]	MIN [inch]	MAX [inch]
a	30.0	30.6	1.181	1.205
b	typ. 0.25		typ. 0.010	
c	64.0	65.0	2.520	2.559
d	typ. 6.4		typ. 0.250	
e	4.9	5.1	0.193	0.201
f	28.6	29.2	1.126	1.150
g	7.3	7.7	0.287	0.303
h	93.5	94.5	3.681	3.720
i	79.5	80.5	3.130	3.169
j	4.8	5.2	0.189	0.205
k	33.4	34.0	1.315	1.339
l	16.7	17.3	0.657	0.681
m	22.7	23.3	0.894	0.917
n	22.7	23.3	0.894	0.917
o	14.0	15.0	0.551	0.591
p	typ. 10.5		typ. 0.413	
q	22.8	23.3	0.898	0.917
r	1.8	2.4	0.071	0.041

Optional accessories for modules

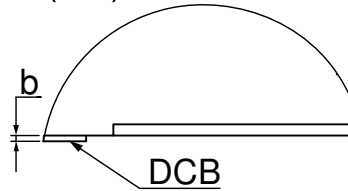
Keyed gate/cathode twin plugs with wire length = 350 mm, gate = white, cathode = red

Type ZY 180L (L = Left for pin pair 4/5)

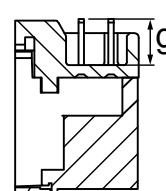
Type ZY 180R (R = Right for pin pair 6/7) } UL 758, style 3751



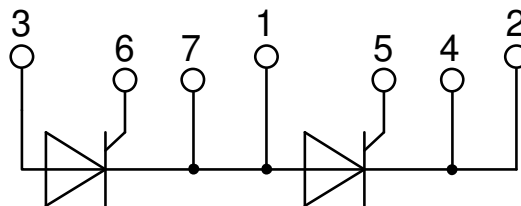
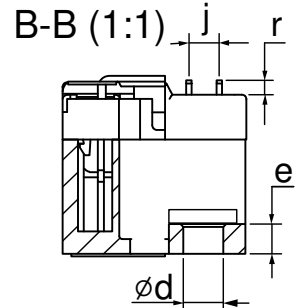
A (3:1)



C-C (1:1)



B-B (1:1)



Thyristor

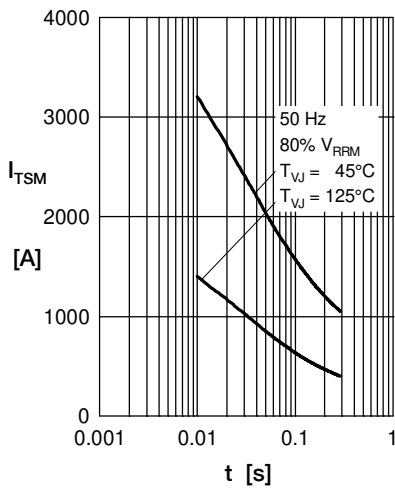


Fig. 1 Surge overload current I_{TSM} , I_{FSM} : Crest value, t : duration

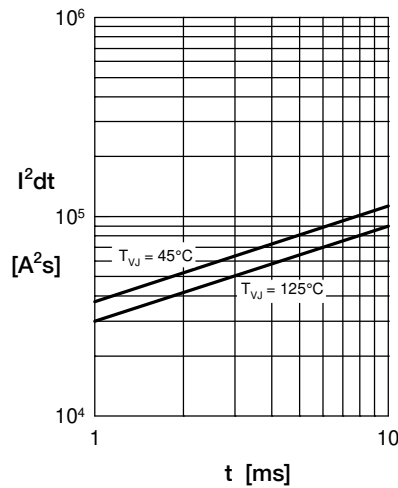


Fig. 2 I^2t versus time (1-10 ms)

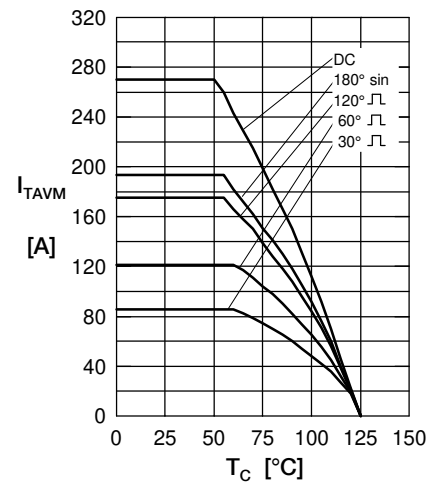


Fig. 3 Max. forward current at case temperature

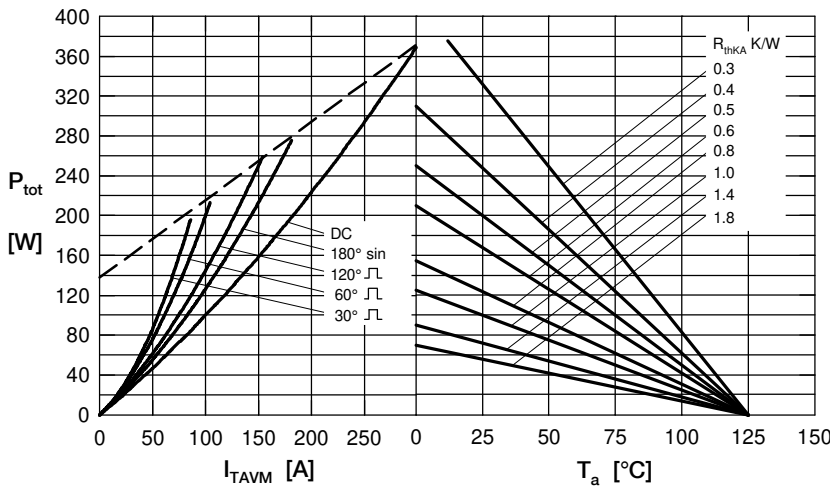


Fig. 4 Power dissipation vs. on-state current & ambient temperature (per thyristor or diode)

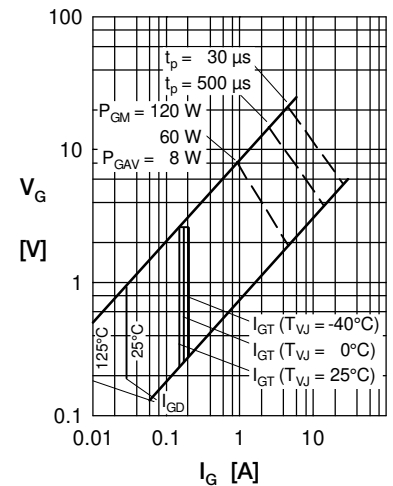


Fig. 5 Gate trigger characteristics

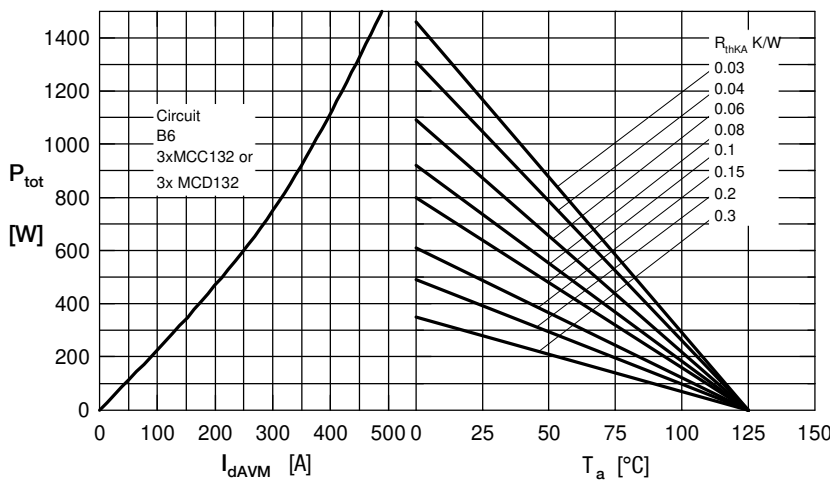


Fig. 6 Three phase rectifier bridge: Power dissipation versus direct output current and ambient temperature

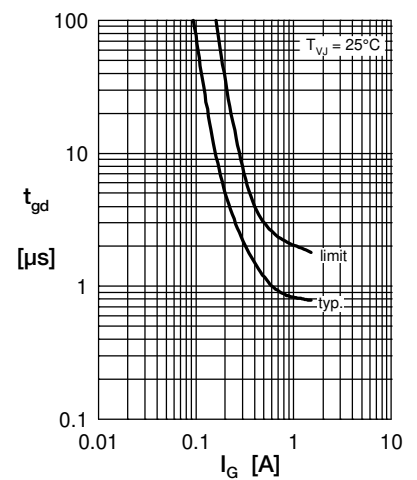


Fig. 7 Gate trigger delay time

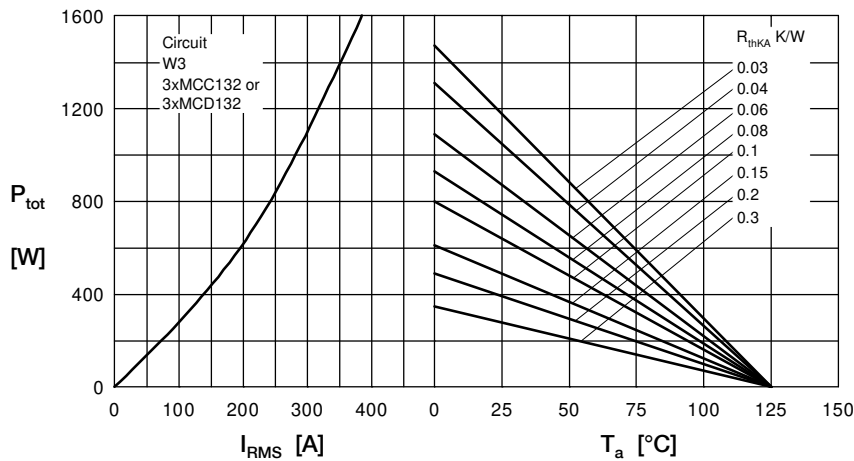
Thyristor


Fig. 8 Three phase AC-controller: Power dissipation versus RMS output current and ambient temperature

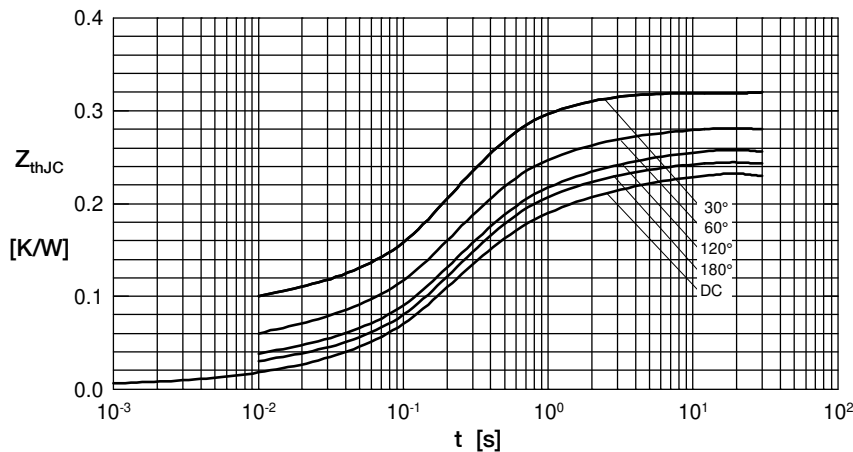


Fig. 9 Transient thermal impedance junction to case (per thyristor/diode)

R_{thJC} for various conduction angles d :

d	R_{thJC} [K/W]
DC	0.230
180°	0.244
120°	0.255
60°	0.283
30°	0.321

Constants for Z_{thJC} calculation:

i	R_{thi} [K/W]	t_i [s]
1	0.0095	0.001
2	0.0175	0.065
3	0.2030	0.400

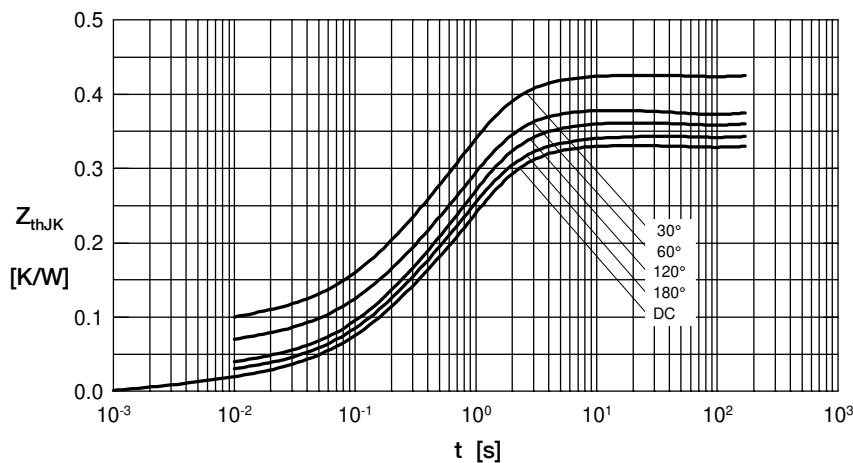


Fig. 10 Transient thermal impedance junction to heatsink (per thyristor/diode)

R_{thJK} for various conduction angles d :

d	R_{thJK} [K/W]
DC	0.330
180°	0.344
120°	0.355
60°	0.383
30°	0.421

Constants for Z_{thJK} calculation:

i	R_{thi} [K/W]	t_i [s]
1	0.0095	0.001
2	0.0175	0.065
3	0.2030	0.400
4	0.1000	1.290