

# SiC Power MOSFET

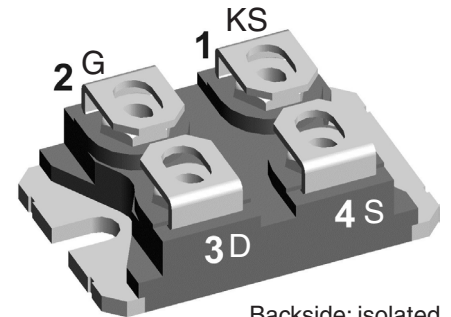
$$I_{D25} = 90 \text{ A}$$

$$V_{DSS} = 1700 \text{ V}$$

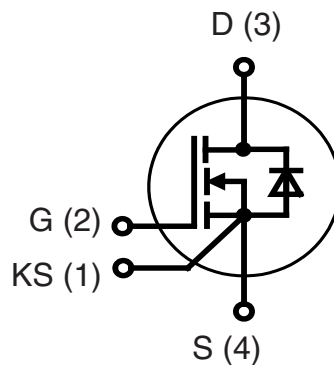
$$R_{DS(on) \text{ max}} = 35 \text{ m}\Omega$$

Kelvin Source gate connection

**Part number**  
IXFN90N170SK



Backside: isolated  
 E72873



### Features / Advantages:

- High speed switching with low capacitances
- High blocking voltage with low  $R_{DS(on)}$
- Easy to parallel and simple to drive
- Resistant to latch-up
- Real Kelvin source connection

### Applications:

- Solar inverters
- High voltage DC/DC converters
- Motor drives
- Switch mode power supplies
- UPS
- Battery chargers
- Induction heating

### Package: SOT-227B (minibloc)

- Isolation Voltage: 2500 V~
- Industry standard outline
- RoHS compliant
- Epoxy meets UL 94V-0
- Base plate with Aluminium nitride isolation
- Advanced power cycling

### Disclaimer Notice

Information furnished is believed to be accurate and reliable. However, users should independently evaluate the suitability of and test each product selected for their own applications. Littelfuse products are not designed for, and may not be used in, all applications. Read complete Disclaimer Notice at [www.littelfuse.com/disclaimer-electronics](http://www.littelfuse.com/disclaimer-electronics).

MOSFET				Ratings			
Symbol	Definitions	Conditions	min.	typ.	max.		
$V_{(BR)DSS}$	drain source breakdown voltage	$I_D = 200 \mu A$ <span style="float:right"><math>T_{VJ} = 25^\circ C</math></span>	1700			V	
$V_{GS(max)}$	max transient gate source voltage		-10		+25	V	
$V_{GS}$	continous gate source voltage	recommended operational value	-5		+20	V	
$I_{D25}$	drain current	$V_{GS} = 20 V$			90	A	
$I_{D80}$			$T_C = 25^\circ C$			67	A
$I_{D100}$			$T_C = 80^\circ C$			56	A
$R_{DS(on)}$	static drain source on resistance	$I_D = 100 A; V_{GS} = 20 V$	$T_{VJ} = 25^\circ C$		23	35	mΩ
			$T_{VJ} = 150^\circ C$		45		mΩ
$V_{GS(th)}$	gate threshold voltage	$I_D = 36 mA; V_{GS} = V_{DS}$	$T_{VJ} = 25^\circ C$	2.0	2.4	4.0	V
			$T_{VJ} = 150^\circ C$		1.8		V
$I_{DSS}$	drain source leakage current	$V_{DS} = 1700 V; V_{GS} = 0 V$ <span style="float:right"><math>T_{VJ} = 25^\circ C</math></span>		5	200	$\mu A$	
$I_{GSS}$	gate source leakage current	$V_{DS} = 0 V; V_{GS} = 20 V$ <span style="float:right"><math>T_{VJ} = 25^\circ C</math></span>			1.2	$\mu A$	
$R_G$	internal gate resistance	$f = 1 MHz, V_{AC} = 25 mV, ESR \text{ of } C_{ISS}$		1.9		Ω	
$C_{ISS}$	input capacitance	$V_{DS} = 1000 V; V_{GS} = 0 V; f = 1 MHz \quad T_{VJ} = 25^\circ C$		7340		pF	
$C_{OSS}$	output capacitance				342		pF
$C_{RSS}$	reverse transfer (Miller) capacitance				13.5		pF
$Q_g$	total gate charge	$V_{DS} = 1200 V; I_D = 100A; V_{GS} = -5/20 V$ $T_{VJ} = 25^\circ C$		376		nC	
$Q_{gs}$	gate source charge				88		nC
$Q_{gd}$	gate drain (Miller) charge				114		nC
$t_{d(on)}$	turn-on delay time	Inductive switching $V_{DS} = 1200 V; I_D = 70 A$ <span style="float:right"><math>T_{VJ} = 25^\circ C</math></span> $V_{GS} = -5 / 20 V; R_G = 2.5 \Omega$ (external) Free wheeling diode: Body diode @ $V_{GS} = -5 V$		34		ns	
$t_r$	current rise time				13		ns
$t_{d(off)}$	turn-off delay time				75		ns
$t_f$	current fall time				27		ns
$E_{on}$	turn-on energy per pulse				2.58		mJ
$E_{off}$	turn-off energy per pulse				0.77		mJ
$E_{rec(off)}$	reverse recovery losses at turn-off				0.66		mJ
$t_{d(on)}$	turn-on delay time	Inductive switching $V_{DS} = 1200 V; I_D = 70 A$ <span style="float:right"><math>T_{VJ} = 150^\circ C</math></span> $V_{GS} = -5 / 20 V; R_G = 2.5 \Omega$ (external) Free wheeling diode: Body diode @ $V_{GS} = -5 V$		36		ns	
$t_r$	current rise time				13		ns
$t_{d(off)}$	turn-off delay time				105		ns
$t_f$	current fall time				33		ns
$E_{on}$	turn-on energy per pulse				4.90		mJ
$E_{off}$	turn-off energy per pulse				1.05		mJ
$E_{rec(off)}$	reverse recovery losses at turn-off				1.89		mJ
$R_{thJC}$	thermal resistance junction to case	with heatsink compound; IXYS test setup		0.30	0.22	K/W	
$R_{thJH}$	thermal resistance junction to heatsink					K/W	

Source-Drain Diode				Ratings			
Symbol	Definitions	Conditions	min.	typ.	max.		
$V_{SD}$	forward voltage drop	$I_F = 70 A; V_{GS} = -5 V$	$T_{VJ} = 25^\circ C$		4.3	V	
			$T_{VJ} = 150^\circ C$		3.8	V	
$t_{rr}$	reverse recovery time	$V_{GS} = -5 V; I_F = 70 A; V_R = 1200 V$ <span style="float:right"><math>T_{VJ} = 25^\circ C</math></span> Mosfet gate drive: $V_{GS} = -5 / 20 V; R_G = 2.5 \Omega$		24		ns	
$Q_{RM}$	reverse recovery charge (intrinsic diode)			1.4		$\mu C$	
$I_{RM}$	max. reverse recovery current				92		A
$dI_F/dt$	current slew rate				7300		A/ $\mu s$
$t_{rr}$	reverse recovery time	$V_{GS} = -5 V; I_F = 70 A; V_R = 1200 V$ <span style="float:right"><math>T_{VJ} = 150^\circ C</math></span> Mosfet gate drive: $V_{GS} = -5 / 20 V; R_G = 2.5 \Omega$		38		ns	
$Q_{RM}$	reverse recovery charge (intrinsic diode)				3.9		$\mu C$
$I_{RM}$	max. reverse recovery current				170		A
$dI_F/dt$	current slew rate				6350		A/ $\mu s$

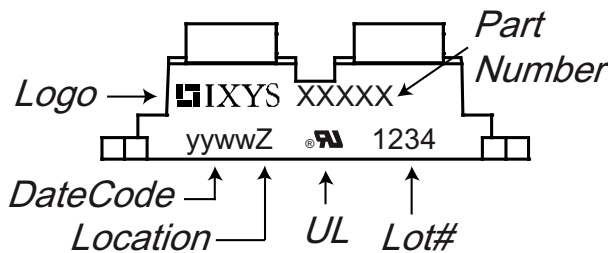
**Note:**

 When using SiC Body Diode the maximum recommended  $V_{GS} = -5V$

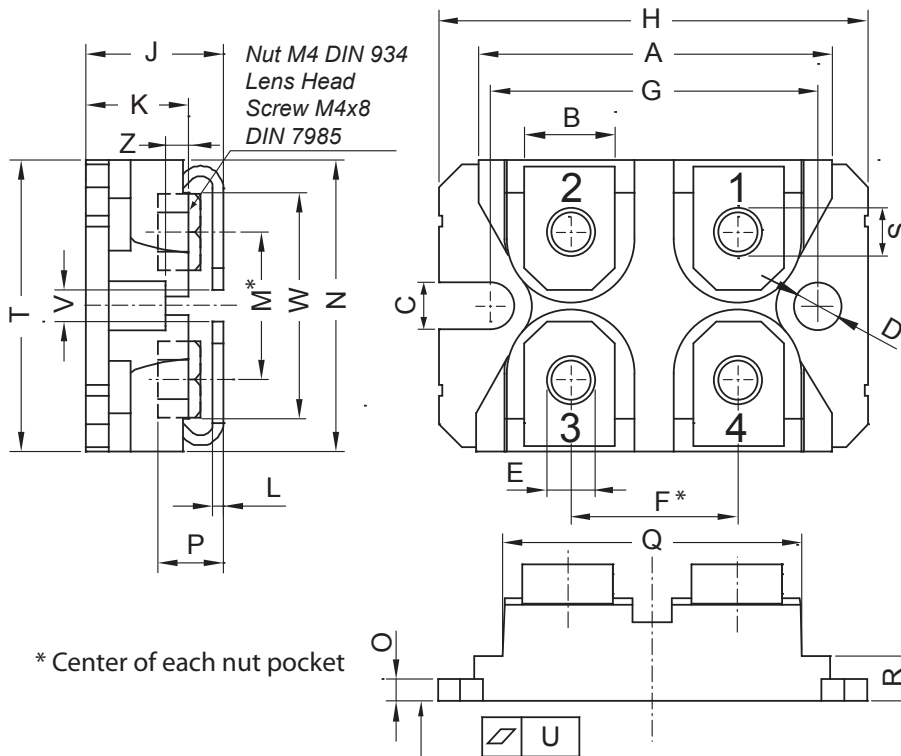
Package Outlines SOT-227B (minibloc)			Ratings			
Symbol	Definitions	Conditions	min.	typ.	max.	Unit
$I_{RMS}$	RMS current	per terminal			100	A
$T_{stg}$	storage temperature		-40		150	°C
$T_{op}$	operation temperature		-40		150	°C
$T_{vJ}$	virtual junction temperature		-40		175	°C
<b>Weight</b>				30		g
$M_D$	mounting torque <sup>1)</sup>	screws to heatsink terminal connection screws			1.5 1.3	Nm Nm
$d_{Spp}$	creepage distance on surface	terminal to terminal	10.5			mm
$d_{Spb}$		terminal to backside	8.5			mm
$d_{App}$	striking distance through air	terminal to terminal	3.2			mm
$d_{Apb}$		terminal to backside	6.8			mm
$V_{ISOL}$	isolation voltage	$I_{ISOL} \leq 1 \text{ mA}; 50/60 \text{ Hz}$	3000 2500			V V
$C_p$	coupling capacity per switch	between drain and back side metallization with gate and source shorted		42		pF

<sup>1)</sup> further information see application note IXAN0073 on [www.ixys.com/TechnicalSupport/appnotes.aspx](http://www.ixys.com/TechnicalSupport/appnotes.aspx) (General / Isolation, Mounting, Soldering, Cooling)

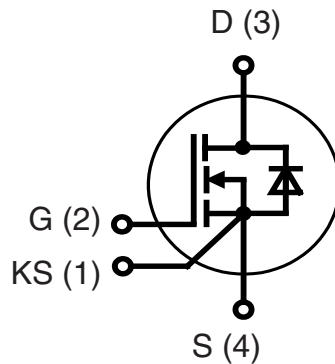
## Product Marking

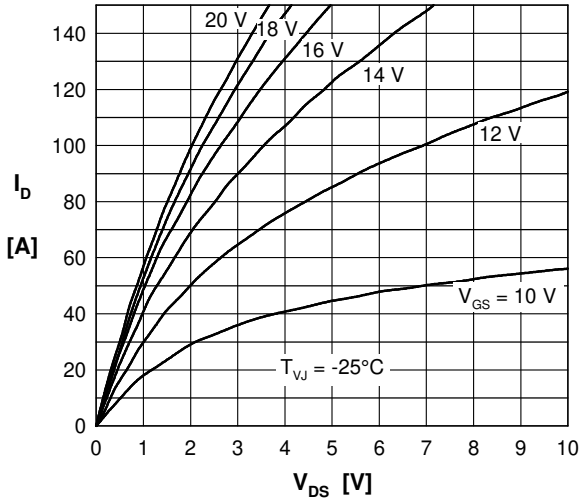
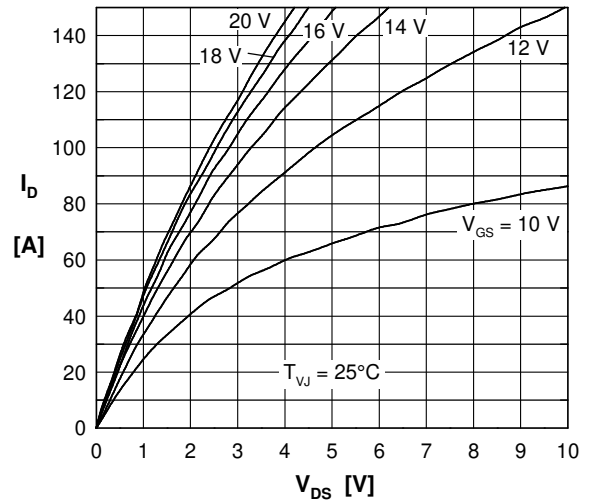
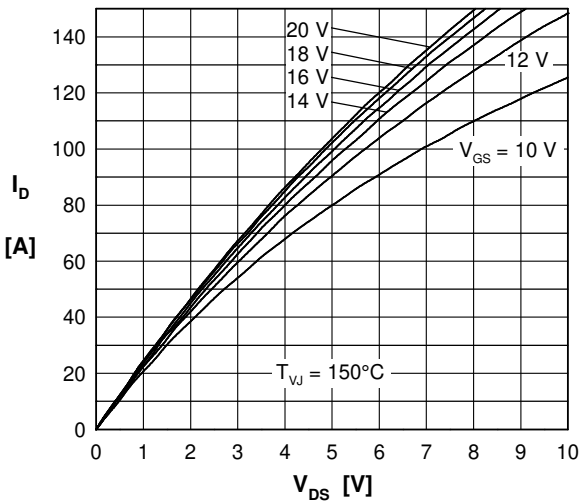
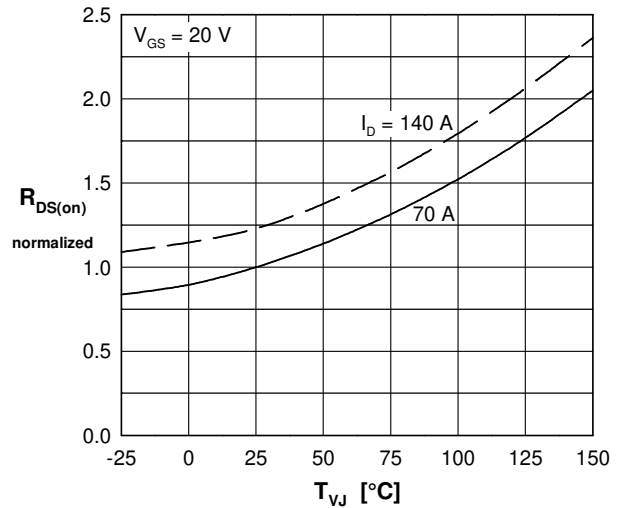
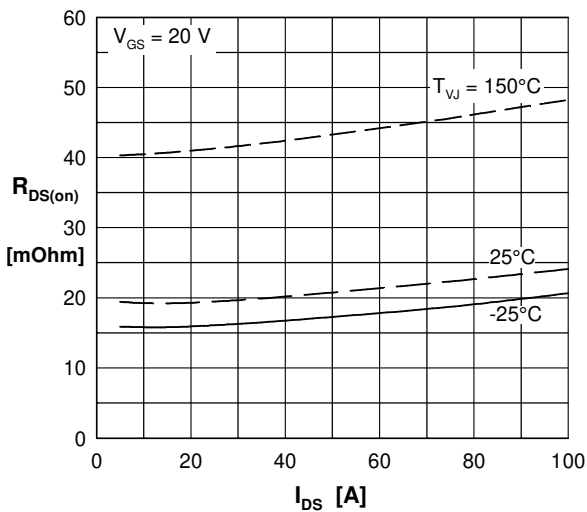
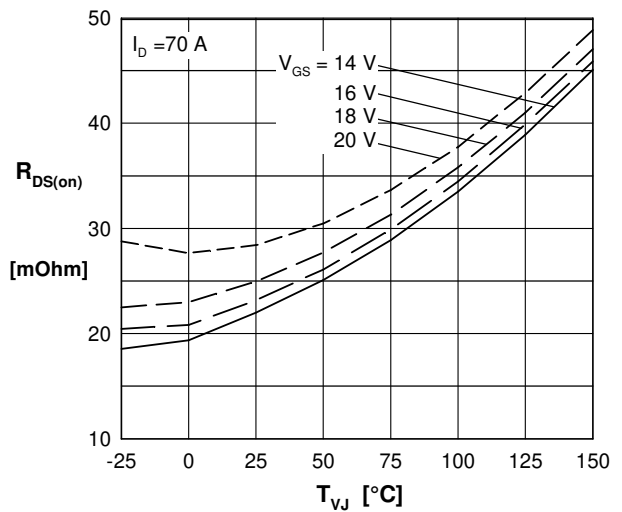


Ordering	Part Name	Marking on Product	Delivering Mode	Base Qty	Ordering Code
Standard	IXFN90N170SK	IXFN90N170SK	Tube	10	IXFN90N170SK

**Outlines SOT-227B (minibloc)**


Dim.	Millimeter		Inches	
	min	max	min	max
A	31.50	31.88	1.240	1.255
B	7.80	8.20	0.307	0.323
C	4.09	4.29	0.161	0.169
D	4.09	4.29	0.161	0.169
E	4.09	4.29	0.161	0.169
F	14.91	15.11	0.587	0.595
G	30.12	30.30	1.186	1.193
H	37.80	38.23	1.488	1.505
J	11.68	12.22	0.460	0.481
K	8.92	9.60	0.351	0.378
L	0.74	0.84	0.029	0.033
M	12.50	13.10	0.492	0.516
N	25.15	25.42	0.990	1.001
O	1.95	2.13	0.077	0.084
P	4.95	6.20	0.195	0.244
Q	26.54	26.90	1.045	1.059
R	3.94	4.42	0.155	0.167
S	4.55	4.85	0.179	0.191
T	24.59	25.25	0.968	0.994
U	-0.05	0.10	-0.002	0.004
V	3.20	5.50	0.126	0.217
W	19.81	21.08	0.780	0.830
Z	2.50	2.70	0.098	0.106



**Curves**

 Fig. 1 Typical output characteristics ( $-25^{\circ}\text{C}$ )

 Fig. 2 Typical output characteristics ( $25^{\circ}\text{C}$ )

 Fig. 3 Typical output characteristics ( $150^{\circ}\text{C}$ )

 Fig. 4  $R_{DS(on)}$  normalized vs. junction temperature  $T_{VJ}$ 

 Fig. 5  $R_{DS(on)}$  versus drain current

 Fig. 6  $R_{DS(on)}$  versus junction temperature  $T_{VJ}$

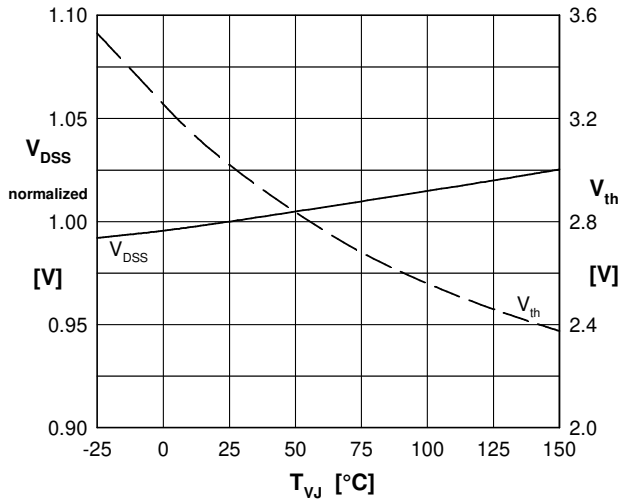
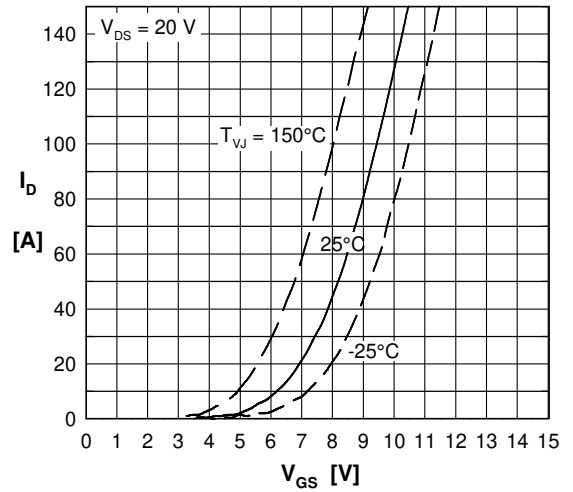
**Curves**

 Fig. 7 Threshold voltage  $V_{TH}$  and normalized  $V_{DSS}$  versus junction temperature  $T_{VJ}$ 


Fig. 8 Typical transfer characteristics

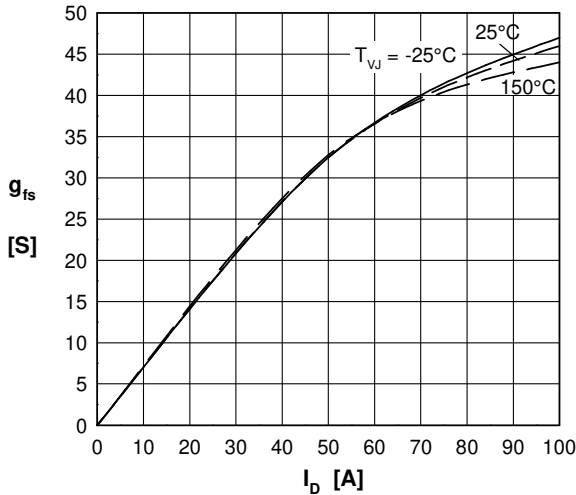
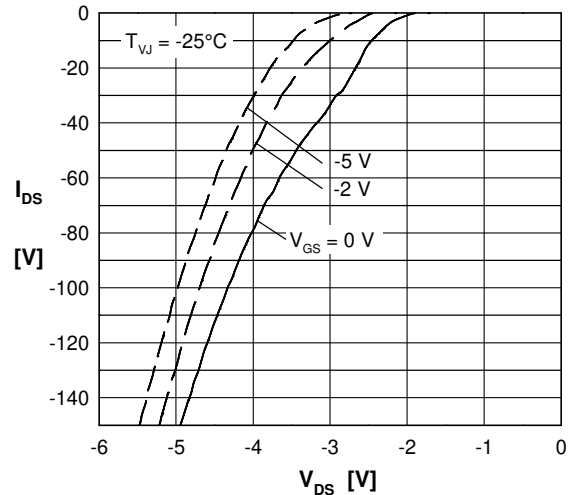
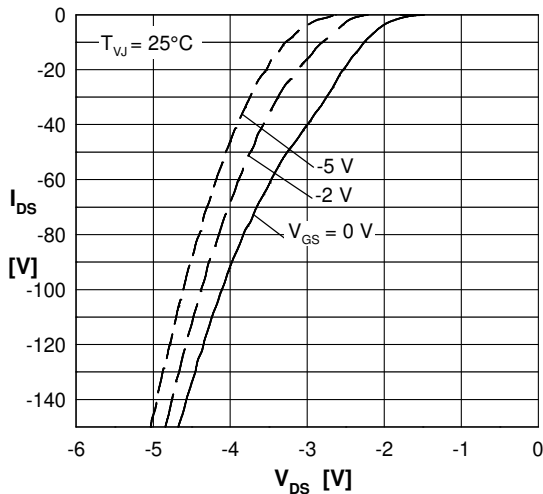
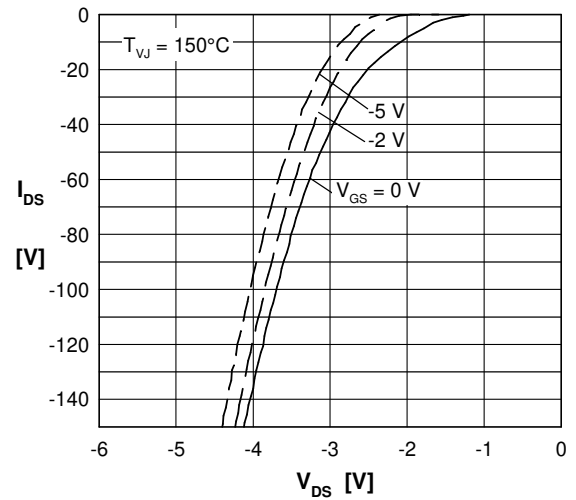


Fig. 9 Typical forward transconductance


 Fig. 10 Forward voltage drop of intrinsic diode versus  $V_{DS}$  measured at  $-25^{\circ}\text{C}$ 

 Fig. 11 Forward voltage drop of intrinsic diode versus  $V_{DS}$  measured at  $25^{\circ}\text{C}$ 

 Fig. 12 Forward voltage drop of intrinsic diode versus  $V_{DS}$  measured at  $150^{\circ}\text{C}$

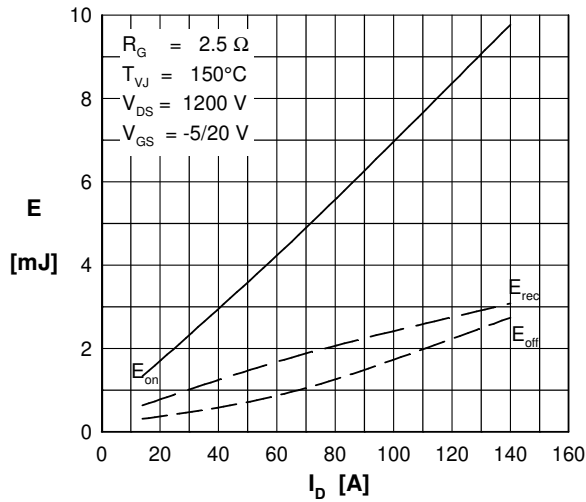
**Curves**


Fig. 13 Typical switching energy versus drain current

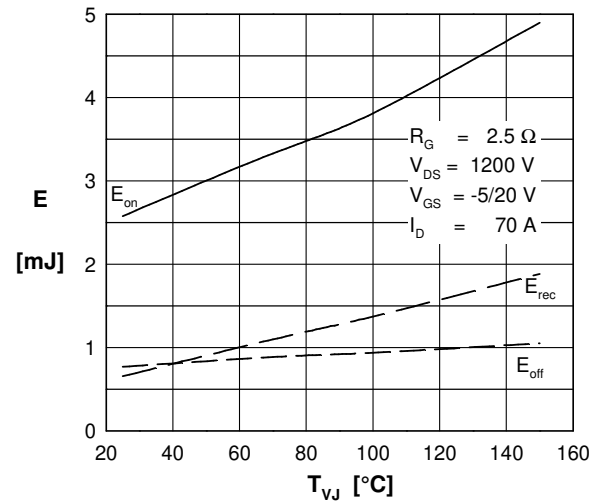


Fig. 14 Typical switching energy versus temperature

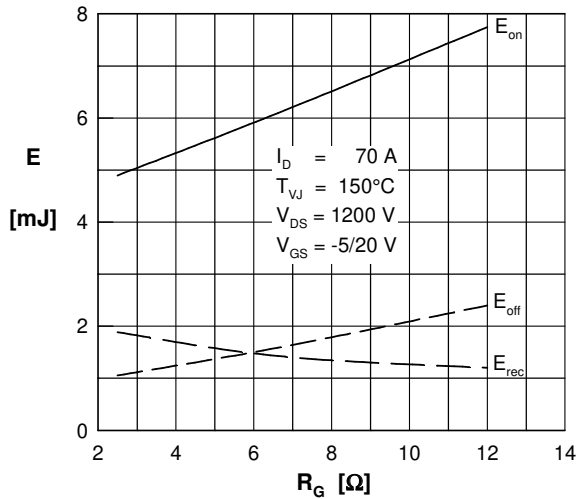


Fig. 15 Typical switching energy versus external gate resistor

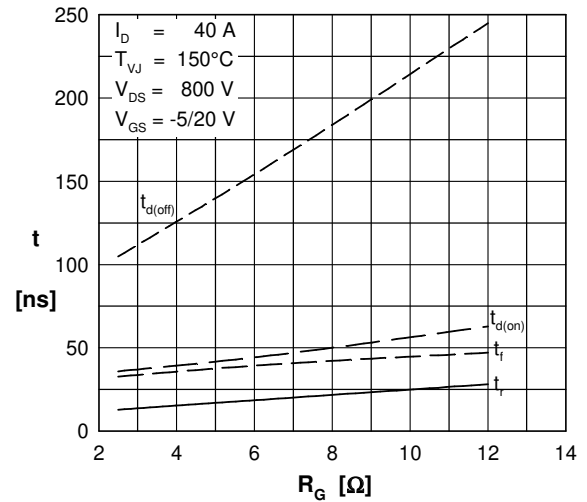


Fig. 16 Typical switching time versus external gate resistor

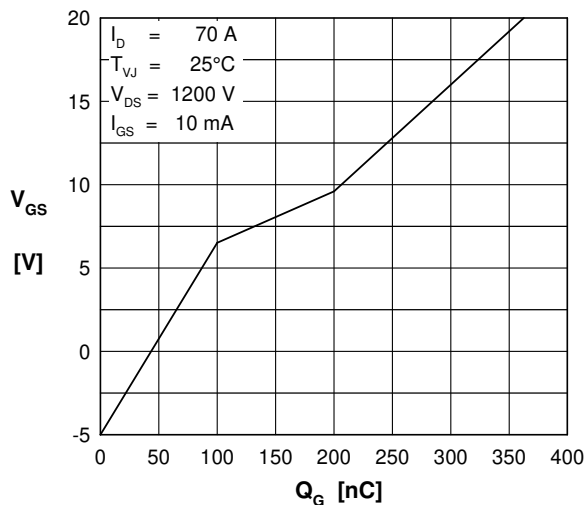


Fig. 17 Typical turn on gate charge, trendline

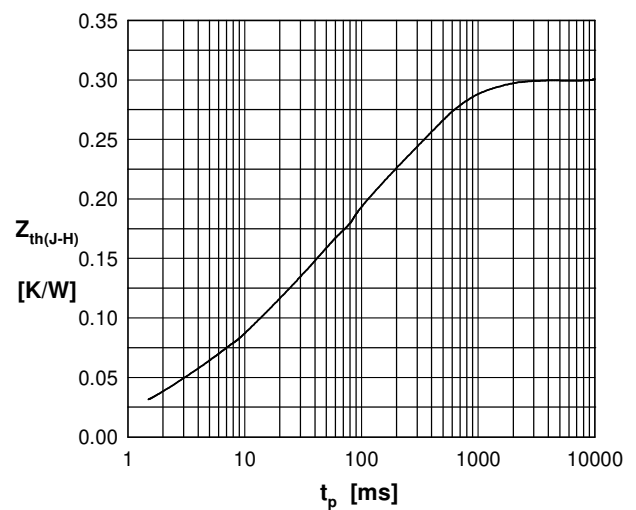


Fig. 18 Typical transient thermal impedance