

SiC Power MOSFET

$$I_{D25} = 27 \text{ A}$$

$$V_{DSS} = 1200 \text{ V}$$

$$R_{DS(on) \text{ max}} = 98 \text{ m}\Omega$$

Kelvin Source gate connection

Part number
IXFN27N120SK

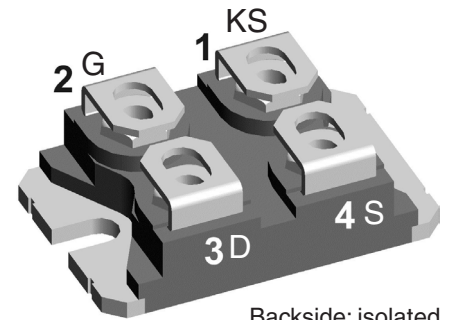

Backside: isolated
 E72873

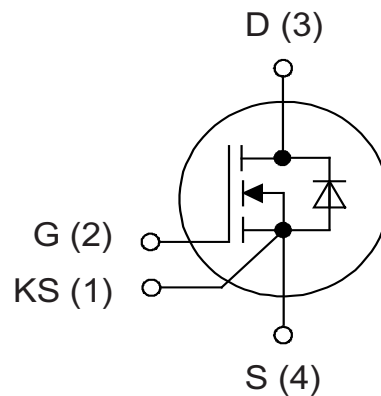

Features / Advantages:

- High speed switching with low capacitances
- High blocking voltage with low $R_{DS(on)}$
- Easy to parallel and simple to drive
- Resistant to latch-up
- Real Kelvin source connection

Applications:

- Solar inverters
- High voltage DC/DC converters
- Motor drives
- Switch mode power supplies
- UPS
- Battery chargers
- Induction heating

Package: SOT-227B (minibloc)

- Isolation Voltage: 2500 V~
- Industry standard outline
- RoHS compliant
- Epoxy meets UL 94V-0
- Base plate with Aluminium nitride isolation
- Advanced power cycling

Disclaimer Notice

Information furnished is believed to be accurate and reliable. However, users should independently evaluate the suitability of and test each product selected for their own applications. Littelfuse products are not designed for, and may not be used in, all applications. Read complete Disclaimer Notice at www.littelfuse.com/disclaimer-electronics.

MOSFET				Ratings			
Symbol	Definitions	Conditions	min.	typ.	max.		
$V_{(BR)DSS}$	drain source breakdown voltage	$I_D = 100 \mu A$	1200			V	
$V_{GS(max)}$	max transient gate source voltage		-10		+25	V	
V_{GS}	continous gate source voltage	recommended operational value	-5		+20	V	
I_{D25}	drain current	$V_{GS} = 20 V$			27	A	
I_{D80}			$T_C = 25^\circ C$		21.5	A	
I_{D100}			$T_C = 80^\circ C$		19	A	
		$T_C = 100^\circ C$					
$I_{D(pulse)}$	pulsed drain current	pulse width limited by $T_{VJ max}$			70	A	
P_D	power dissipation	$T_C = 25^\circ C, T_{VJ} = 175^\circ C$			150	W	
R_{DSon}	static drain source on resistance	$I_D = 20 A; V_{GS} = 20 V$		80	98	mΩ	
			$T_{VJ} = 25^\circ C$		155		mΩ
		$T_{VJ} = 175^\circ C$					
$V_{GS(th)}$	gate threshold voltage	$I_D = 5 mA; V_{GS} = V_{DS}$		2.0	2.6	V	
			$T_{VJ} = 25^\circ C$		2.1		V
		$T_{VJ} = 175^\circ C$					
I_{DSS}	drain source leakage current	$V_{DS} = 1200 V; V_{GS} = 0 V$		1	100	μA	
I_{GSS}	gate source leakage current	$V_{DS} = 0 V; V_{GS} = 20 V$			250	nA	
R_G	internal gate resistance	$f = 1 MHz, V_{AC} = 25 mV, ESR \text{ of } C_{ISS}$		4.6		Ω	
C_{ISS}	input capacitance	$V_{DS} = 1000 V; V_{GS} = 0 V; f = 1 MHz, T_{VJ} = 25^\circ C$		950		pF	
C_{OSS}	output capacitance			80		pF	
C_{RSS}	reverse transfer (Miller) capacitance			7.6		pF	
Q_g	total gate charge	$V_{DS} = 800 V; I_D = 40 A; V_{GS} = -5/20 V, T_{VJ} = 25^\circ C$		62		nC	
Q_{gs}	gate source charge			23		nC	
Q_{gd}	gate drain (Miller) charge			37		nC	
$t_{d(on)}$	turn-on delay time	Inductive switching $T_{VJ} = 25^\circ C$ Free Wheeling Diode: Body Diode @ $V_{GS} = -5V$ $V_{DS} = 800 V; I_D = 20 A$ $V_{GS} = -5/20 V; R_G = 22 \Omega$ (external)		10		ns	
t_r	current rise time			8		ns	
$t_{d(off)}$	turn-off delay time			62		ns	
t_f	current fall time			16		ns	
E_{on}	turn-on energy per pulse			0.51		mJ	
E_{off}	turn-off energy per pulse			0.22		mJ	
$E_{rec(off)}$	reverse recovery losses at turn-off			0.02		mJ	
$t_{d(on)}$	turn-on delay time		Inductive switching $T_{VJ} = 150^\circ C$ Free Wheeling Diode: Body Diode @ $V_{GS} = -5V$ $V_{DS} = 800 V; I_D = 20 A$ $V_{GS} = -5/20 V; R_G = 22 \Omega$ (external)		10		ns
t_r	current rise time				8		ns
$t_{d(off)}$	turn-off delay time				70		ns
t_f	current fall time			14		ns	
E_{on}	turn-on energy per pulse			0.63		mJ	
E_{off}	turn-off energy per pulse			0.21		mJ	
$E_{rec(off)}$	reverse recovery losses at turn-off			0.06		mJ	
R_{thJC}	thermal resistance junction to case					1.0	K/W
R_{thJH}	thermal resistance junction to heatsink	with heatsink compound; IXYS test setup			1.25		K/W

Source-Drain Diode				Ratings		
Symbol	Definitions	Conditions	min.	typ.	max.	
V_{SD}	forward voltage drop	$I_F = 20 A; V_{GS} = -5 V$		5.2		V
		$T_{VJ} = 25^\circ C$		4.6		V
		$T_{VJ} = 150^\circ C$				
t_{rr}	reverse recovery time	$V_{GS} = -5 V; I_F = 20 A; V_R = 800 V$ Mofset gate drive: $V_{GS} = -5 / 20 V; R_G = 22 \Omega$		14		ns
Q_{RM}	reverse recovery charge (intrinsic diode)			0.12		μC
I_{RM}	max. reverse recovery current			15		A
dl_F/dt	current slew rate			2320		A/μs
t_{rr}	reverse recovery time	$V_{GS} = -5 V; I_F = 20 A; V_R = 800 V$ Mofset gate drive: $V_{GS} = -5 / 20 V; R_G = 22 \Omega$		29		ns
Q_{RM}	reverse recovery charge (intrinsic diode)			0.48		μC
I_{RM}	max. reverse recovery current			24		A
dl_F/dt	current slew rate			2740		A/μs

Note: When using SiC Body Diode the maximum recommended $V_{GS} = -5V$



Package Outlines SOT-227B (minibloc)			Ratings			
Symbol	Definitions	Conditions	min.	typ.	max.	Unit
I_{RMS}	RMS current	per terminal			100	A
T_{stg}	storage temperature		-40		150	°C
T_{op}	operation temperature		-40		150	°C
T_{vJ}	virtual junction temperature		-40		175	°C
Weight				30		g
M_D	mounting torque ¹⁾	screws to heatsink terminal connection screws			1.5 1.3	Nm Nm
d_{Spp}	creepage distance on surface	terminal to terminal	10.5			mm
d_{Spb}		terminal to backside	8.5			mm
d_{App}	striking distance through air	terminal to terminal	3.2			mm
d_{Apb}		terminal to backside	6.8			mm
V_{ISOL}	isolation voltage	$I_{ISOL} \leq 1 \text{ mA}; 50/60 \text{ Hz}$	3000 2500			V V
C_p	coupling capacity per switch	between drain and back side metallization with gate and source shorted		42		pF

¹⁾ further information see application note IXAN0073 on www.ixys.com/TechnicalSupport/appnotes.aspx (General / Isolation, Mounting, Soldering, Cooling)

Product Marking

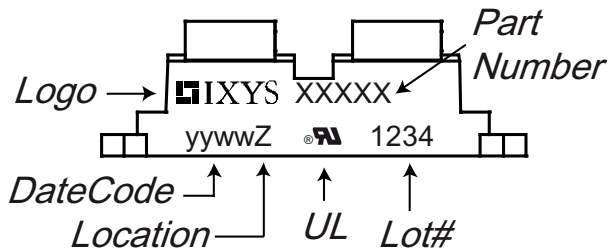

Ordering	Part Name	Marking on Product	Delivering Mode	Base Qty	Ordering Code
Standard	IXFN27N120SK	IXFN27N120SK	Tube	10	IXFN27N120SK

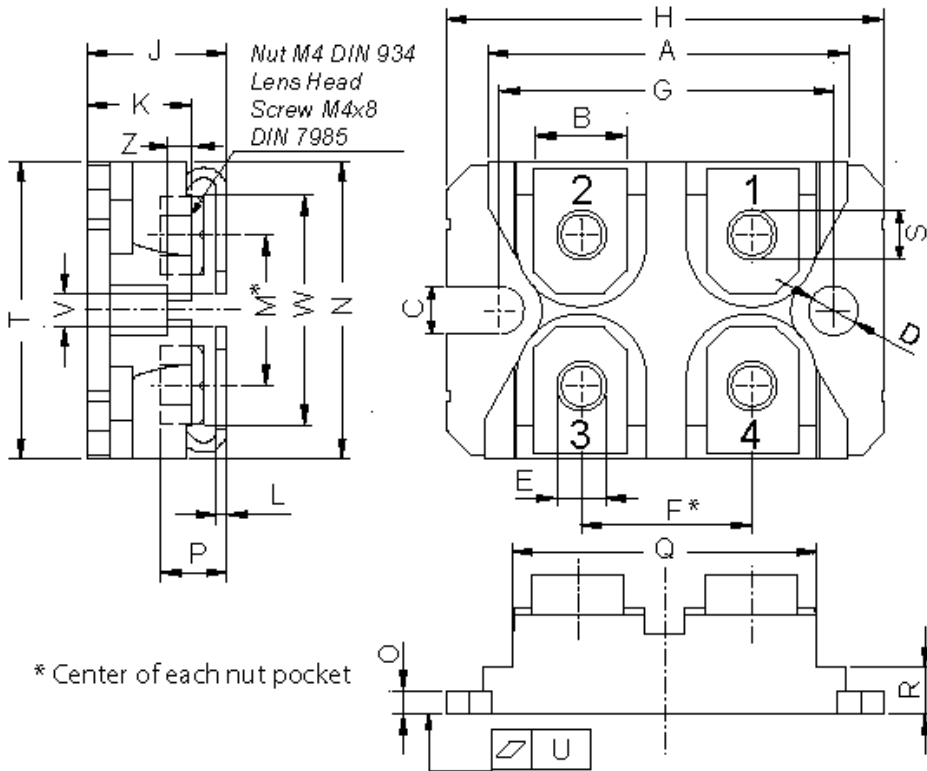
Outlines SOT-227B (minibloc)

Dim.	Millimeter		Inches	
	min	max	min	max
A	31.50	31.88	1.240	1.255
B	7.80	8.20	0.307	0.323
C	4.09	4.29	0.161	0.169
D	4.09	4.29	0.161	0.169
E	4.09	4.29	0.161	0.169
F	14.91	15.11	0.587	0.595
G	30.12	30.30	1.186	1.193
H	37.80	38.23	1.488	1.505
J	11.68	12.22	0.460	0.481
K	8.92	9.60	0.351	0.378
L	0.74	0.84	0.029	0.033
M	12.50	13.10	0.492	0.516
N	25.15	25.42	0.990	1.001
O	1.95	2.13	0.077	0.084
P	4.95	6.20	0.195	0.244
Q	26.54	26.90	1.045	1.059
R	3.94	4.42	0.155	0.167
S	4.55	4.85	0.179	0.191
T	24.59	25.25	0.968	0.994
U	-0.05	0.10	-0.002	0.004
V	3.20	5.50	0.126	0.217
W	19.81	21.08	0.780	0.830
Z	2.50	2.70	0.098	0.106

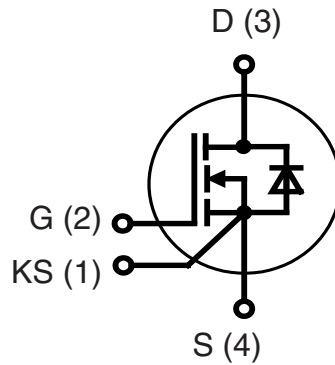

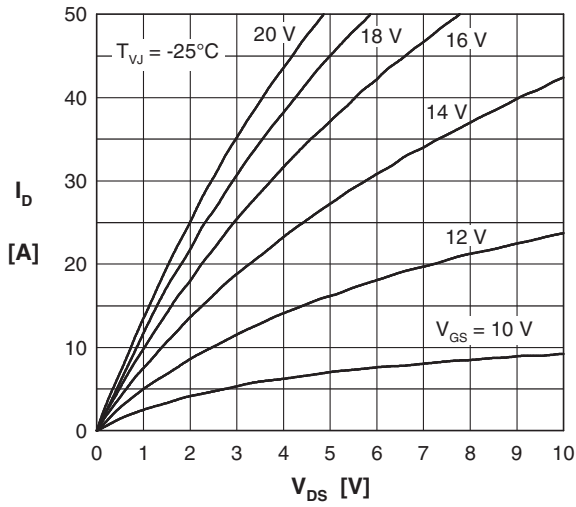
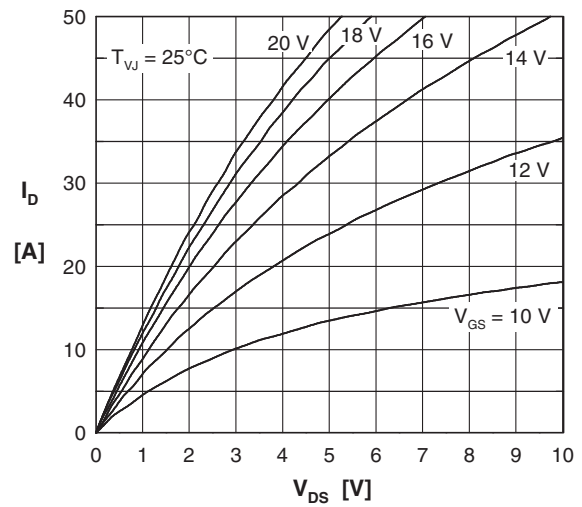
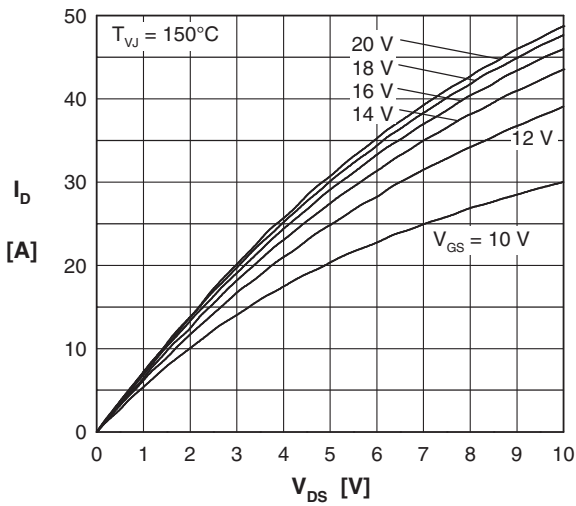
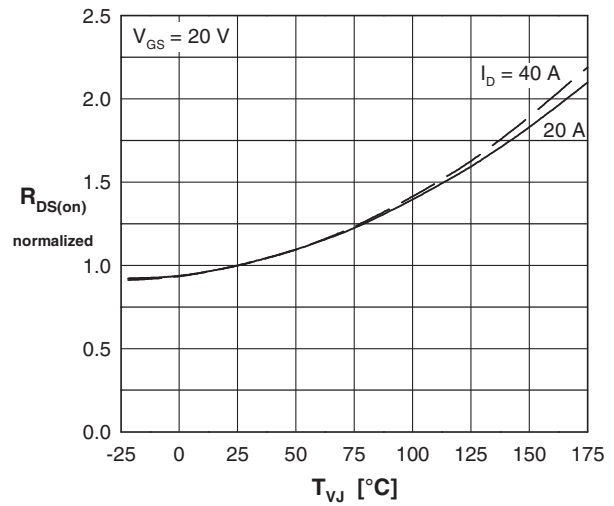
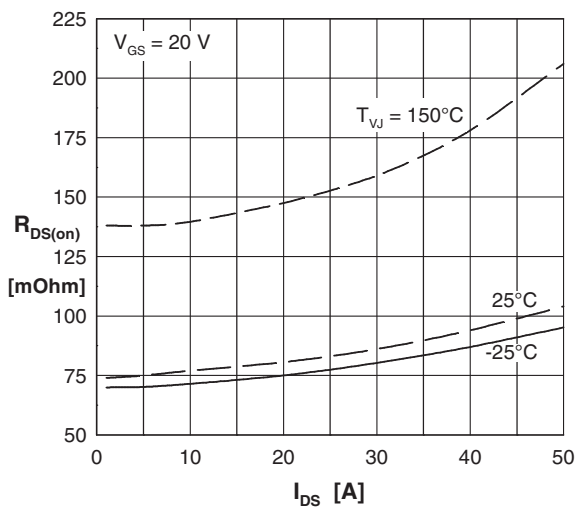
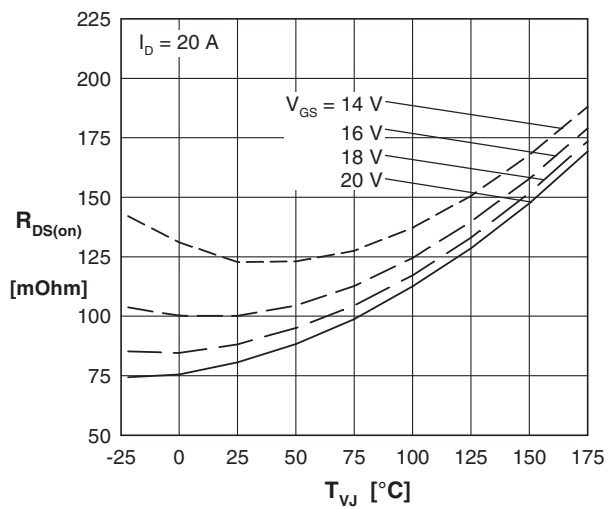
Curves

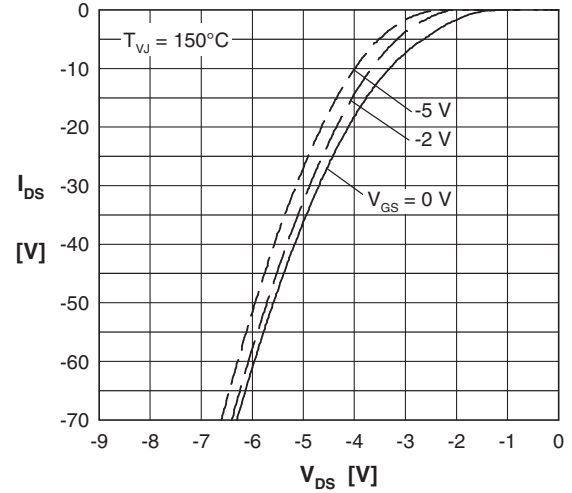
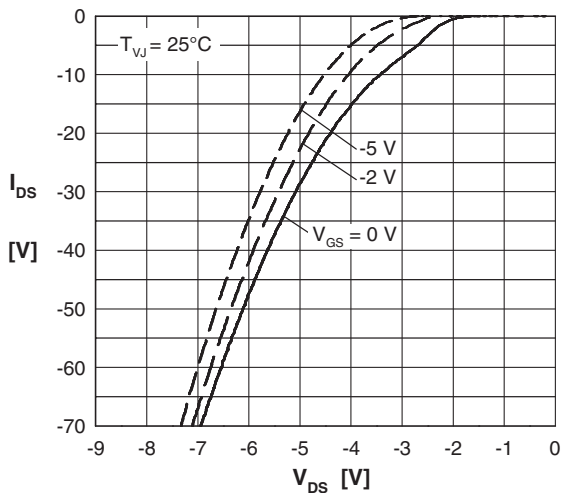
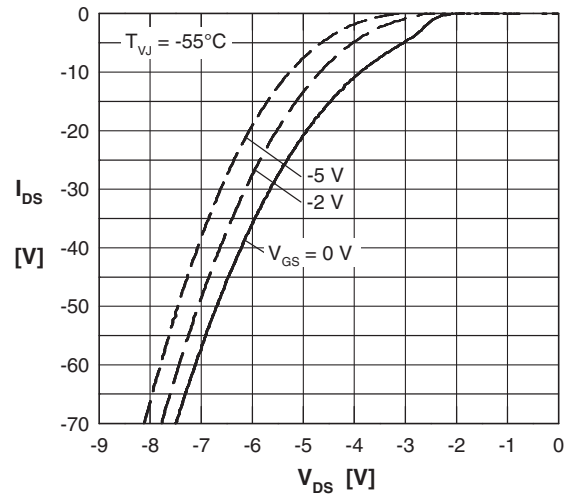
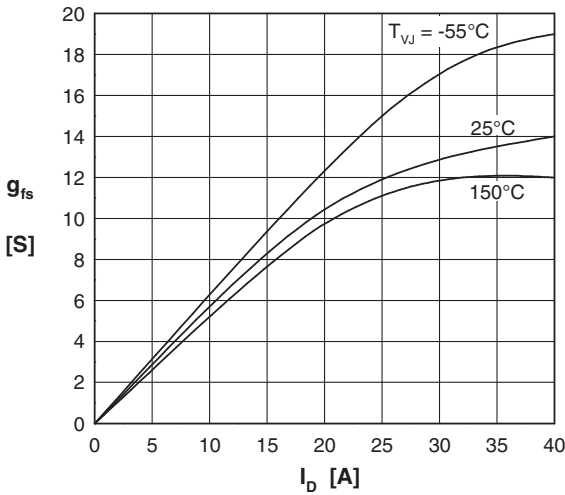
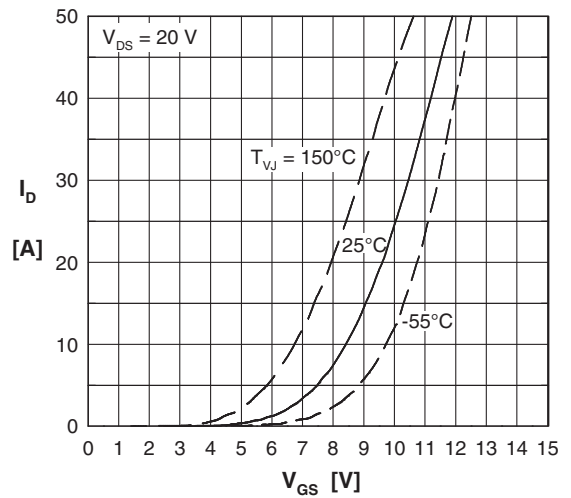
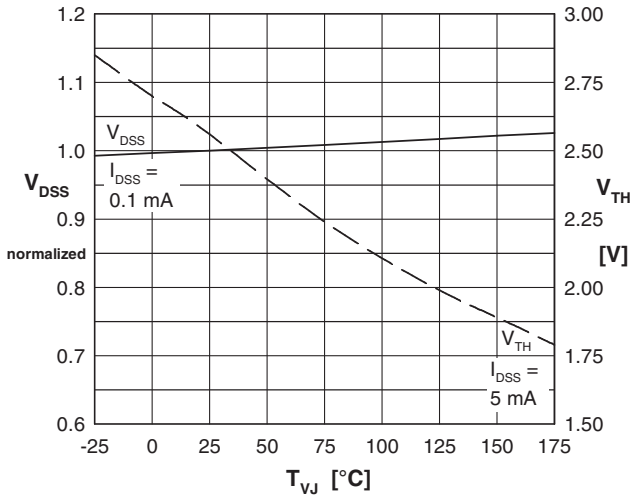
 Fig. 1 Typical output characteristics (-25°C)

 Fig. 2 Typical output characteristics (25°C)

 Fig. 3 Typical output characteristics (150°C)

 Fig. 4 $R_{DS(on)}$ normalized vs. junction temperature T_{VJ}

 Fig. 5 $R_{DS(on)}$ versus drain current

 Fig. 6 $R_{DS(on)}$ versus junction temperature T_{VJ}

Curves



Curves

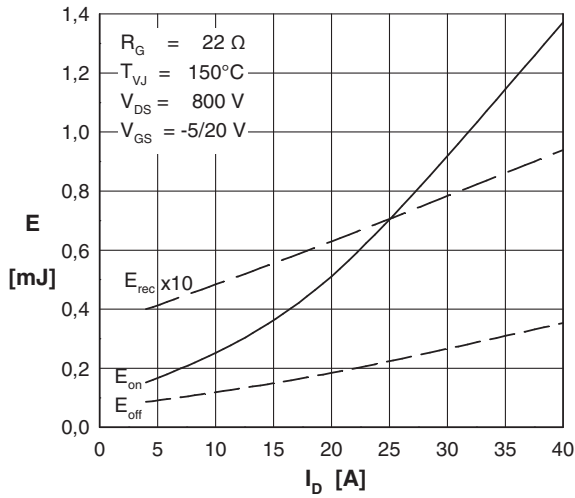

Fig. 13 Typical switching energy versus drain current

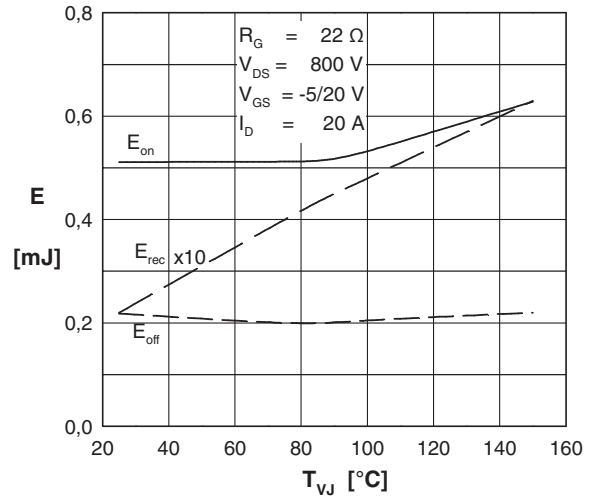

Fig. 14 Typical switching energy versus temperature

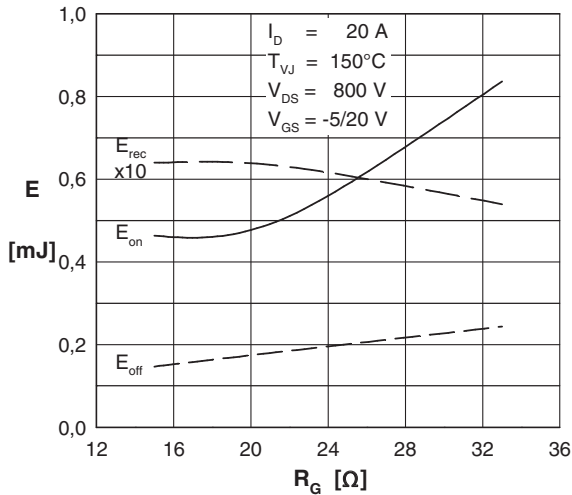

Fig. 15 Typical switching energy versus external gate resistor

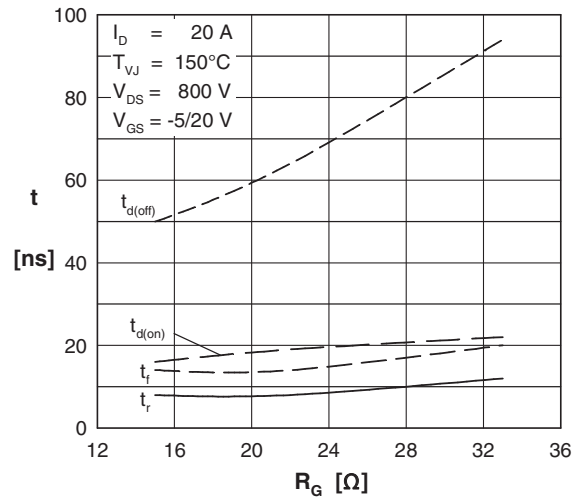

Fig. 16 Typical switching time versus external gate resistor

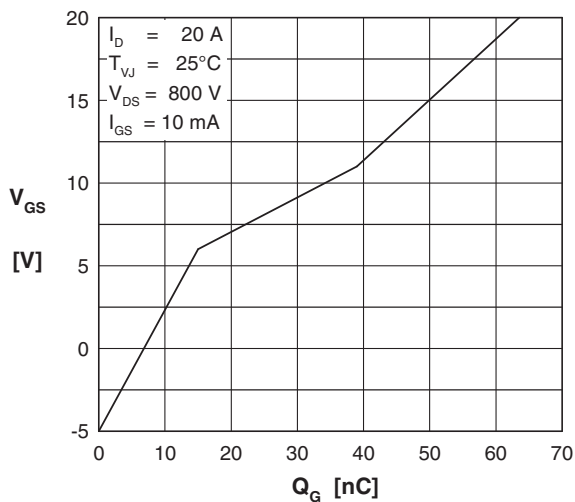

Fig. 17 Typical turn on gate charge, trendline

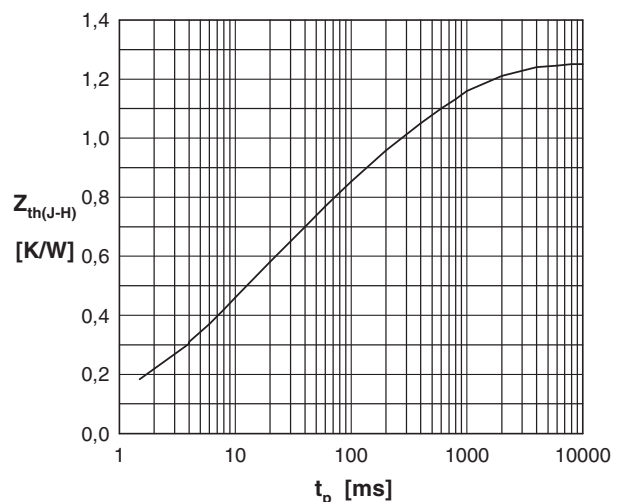

Fig. 18 Typical transient thermal impedance