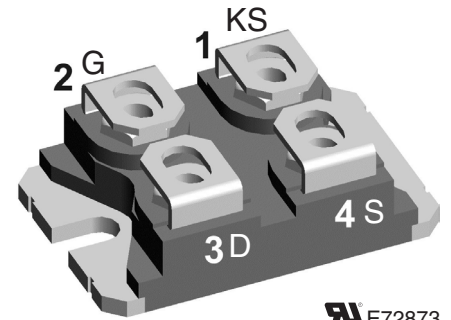


# SiC Power MOSFET

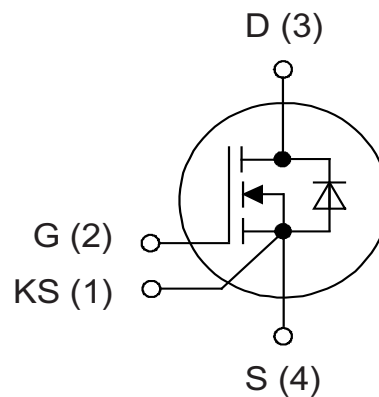
$I_{D25} = 142 \text{ A}$   
 $V_{DSS} = 900 \text{ V}$   
 $R_{DS(on) \text{ max}} = 12 \text{ m}\Omega$

Kelvin Source gate connection

**Part number**  
 IXFN130N90SK



 E72873  
 Backside: isolated



### Features / Advantages:

- High speed switching with low capacitances
- High blocking voltage with low  $R_{DS(on)}$
- Easy to parallel and simple to drive
- Resistant to latch-up
- Real Kelvin source connection

### Applications:

- Solar inverters
- High voltage DC/DC converters
- Motor drives
- Switch mode power supplies
- UPS
- Battery chargers
- Induction heating

### Package: SOT-227B (minibloc)

- Isolation Voltage: 2500 V~
- Industry standard outline
- RoHS compliant
- Epoxy meets UL 94V-0
- Base plate with Aluminium nitride isolation
- Advanced power cycling

### Disclaimer Notice

Information furnished is believed to be accurate and reliable. However, users should independently evaluate the suitability of and test each product selected for their own applications. Littelfuse products are not designed for, and may not be used in, all applications. Read complete Disclaimer Notice at [www.littelfuse.com/disclaimer-electronics](http://www.littelfuse.com/disclaimer-electronics).



MOSFET				Ratings		
Symbol	Definitions	Conditions	min.	typ.	max.	
$V_{(BR)DSS}$	drain source breakdown voltage	$V_{GS} = 0V, I_D = 100 \mu A$	900			V
$V_{GS(max)}$	max transient gate source voltage		-8		+19	V
$V_{GS}$	continuous gate source voltage	recommended operational value	-4		+15	V
$I_{D25}$	drain current	$V_{GS} = 15 V$			142	A
$I_{D80}$					113	A
$I_{D100}$					100	A
$R_{DS(on)}$	static drain source on resistance	$I_D = 75 A; V_{GS} = 15 V$		10 15.5	12	mΩ mΩ
$V_{GS(th)}$	gate threshold voltage	$I_D = 33 mA; V_{GS} = V_{DS}$	1.7	2.4 1.7	3.5	V V
$I_{DSS}$	drain source leakage current	$V_{DS} = 900 V; V_{GS} = 0 V$		1	100	μA
$I_{GSS}$	gate source leakage current	$V_{DS} = 0 V; V_{GS} = 15 V$			250	nA
$R_G$	internal gate resistance	$f = 1 MHz, V_{AC} = 25 mV, ESR \text{ of } C_{ISS}$		1.6		Ω
$C_{ISS}$	input capacitance			4500		pF
$C_{OSS}$	output capacitance	$V_{DS} = 600 V; V_{GS} = 0 V; f = 1 MHz$		350		pF
$C_{RSS}$	reverse transfer (Miller) capacitance	$T_{VJ} = 25^\circ C$		12		pF
$Q_g$	total gate charge	$V_{DS} = 600 V; I_D = 100 A; V_{GS} = -4/15 V$		222		nC
$Q_{gs}$	gate source charge	$T_{VJ} = 25^\circ C$		80		nC
$Q_{gd}$	gate drain (Miller) charge			68		nC
$t_{d(on)}$	turn-on delay time			26.6		ns
$t_r$	current rise time	Inductive switching		12		ns
$t_{d(off)}$	turn-off delay time	$V_{DS} = 600 V; I_D = 100 A$		67		ns
$t_f$	current fall time	$T_{VJ} = 25^\circ C$		15.4		ns
$E_{on}$	turn-on energy per pulse	$V_{GS} = -4 / 15 V; R_G = 2.5 \Omega$ (external)		1.0		mJ
$E_{off}$	turn-off energy per pulse	Freewheeling diode is Mosfet's body diode		0.47		mJ
$E_{rec(off)}$	reverse recovery losses at turn-off			0.58		mJ
$t_{d(on)}$	turn-on delay time			25.8		ns
$t_r$	current rise time	Inductive switching		11.1		ns
$t_{d(off)}$	turn-off delay time	$V_{DS} = 600 V; I_D = 100 A$		75		ns
$t_f$	current fall time	$T_{VJ} = 150^\circ C$		16.7		ns
$E_{on}$	turn-on energy per pulse	$V_{GS} = -4 / 15 V; R_G = 2.5 \Omega$ (external)		1.07		mJ
$E_{off}$	turn-off energy per pulse	Freewheeling diode is Mosfet's body diode		0.53		mJ
$E_{rec(off)}$	reverse recovery losses at turn-off			0.84		mJ
$R_{thJC}$	thermal resistance junction to case				0.40	K/W
$R_{thJH}$	thermal resistance junction to heatsink	with heatsink compound; IXYS test setup		0.5		K/W

Source-Drain Diode				Ratings		
Symbol	Definitions	Conditions	min.	typ.	max.	
$V_{SD}$	forward voltage drop	$I_F = 70 A; V_{GS} = -4 V$		4.9 4.5		V V
$t_{rr}$	reverse recovery time	$V_{GS} = -4 V; I_F = 100 A; V_R = 600 V$		22		ns
$Q_{RM}$	reverse recovery charge (intrinsic diode)	Mosfet gate drive:		1.4		μC
$I_{RM}$	max. reverse recovery current	$V_{GS} = -4 / 15 V; R_G = 2.5 \Omega$		106		A
$dl_F/dt$	current slew rate			10300		A/μs
$t_{rr}$	reverse recovery time	$V_{GS} = -4 V; I_F = 100 A; V_R = 600 V$		23		ns
$Q_{RM}$	reverse recovery charge (intrinsic diode)	Mosfet gate drive:		1.9		μC
$I_{RM}$	max. reverse recovery current	$V_{GS} = -4 / 15 V; R_G = 2.5 \Omega$		148		A
$dl_F/dt$	current slew rate			11400		A/μs

**Note:**

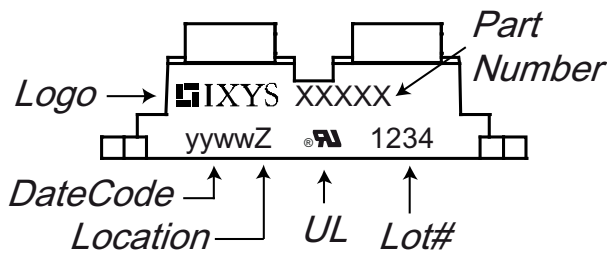
When using SiC Body Diode the maximum recommended  $V_{GS} = -4V$



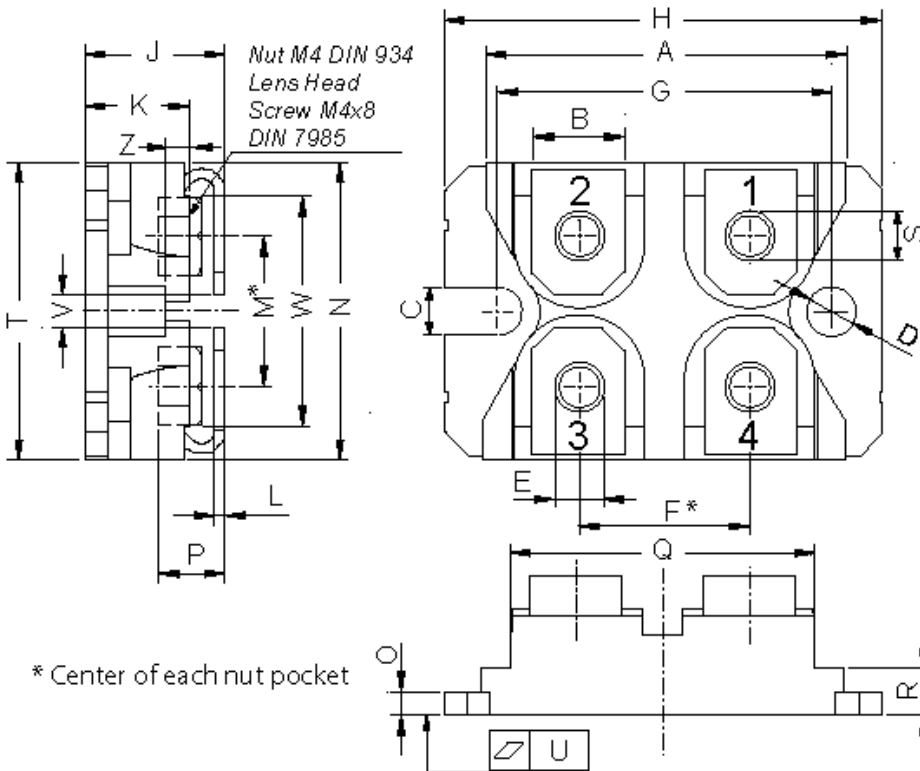
Package Outlines SOT-227B (minibloc)			Ratings			
Symbol	Definitions	Conditions	min.	typ.	max.	Unit
$I_{RMS}$	RMS current	per terminal			100	A
$T_{stg}$	storage temperature		-40		150	°C
$T_{op}$	operation temperature		-40		150	°C
$T_{vJ}$	virtual junction temperature		-40		175	°C
<b>Weight</b>				30		g
$M_D$	mounting torque <sup>1)</sup>	screws to heatsink terminal connection screws			1.5 1.3	Nm Nm
$d_{Spp}$	creepage distance on surface	terminal to terminal	10.5			mm
$d_{Spb}$		terminal to backside	8.5			mm
$d_{App}$	striking distance through air	terminal to terminal	3.2			mm
$d_{Apb}$		terminal to backside	6.8			mm
$V_{ISOL}$	isolation voltage	$I_{ISOL} \leq 1 \text{ mA}; 50/60 \text{ Hz}$	3000 2500			V V
$C_p$	coupling capacity per switch	between drain and back side metallization with gate and source shorted		42		pF

<sup>1)</sup> further information see application note IXAN0073 on [www.ixys.com/TechnicalSupport/appnotes.aspx](http://www.ixys.com/TechnicalSupport/appnotes.aspx) (General / Isolation, Mounting, Soldering, Cooling)

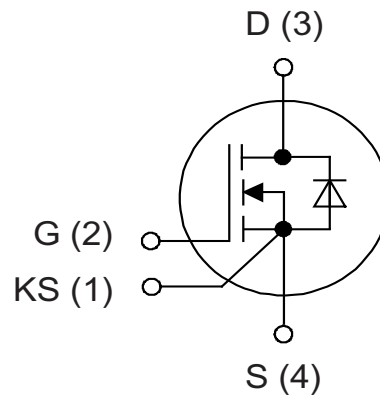
### Product Marking



Ordering	Part Name	Marking on Product	Delivering Mode	Base Qty	Ordering Code
Standard	IXFN130N90SK	IXFN130N90SK	Tube	10	IXFN130N90SK

**Outlines SOT-227B (minibloc)**


Dim.	Millimeter		Inches	
	min	max	min	max
A	31.50	31.88	1.240	1.255
B	7.80	8.20	0.307	0.323
C	4.09	4.29	0.161	0.169
D	4.09	4.29	0.161	0.169
E	4.09	4.29	0.161	0.169
F	14.91	15.11	0.587	0.595
G	30.12	30.30	1.186	1.193
H	37.80	38.23	1.488	1.505
J	11.68	12.22	0.460	0.481
K	8.92	9.60	0.351	0.378
L	0.74	0.84	0.029	0.033
M	12.50	13.10	0.492	0.516
N	25.15	25.42	0.990	1.001
O	1.95	2.13	0.077	0.084
P	4.95	6.20	0.195	0.244
Q	26.54	26.90	1.045	1.059
R	3.94	4.42	0.155	0.167
S	4.55	4.85	0.179	0.191
T	24.59	25.25	0.968	0.994
U	-0.05	0.10	-0.002	0.004
V	3.20	5.50	0.126	0.217
W	19.81	21.08	0.780	0.830
Z	2.50	2.70	0.098	0.106



**Curves**

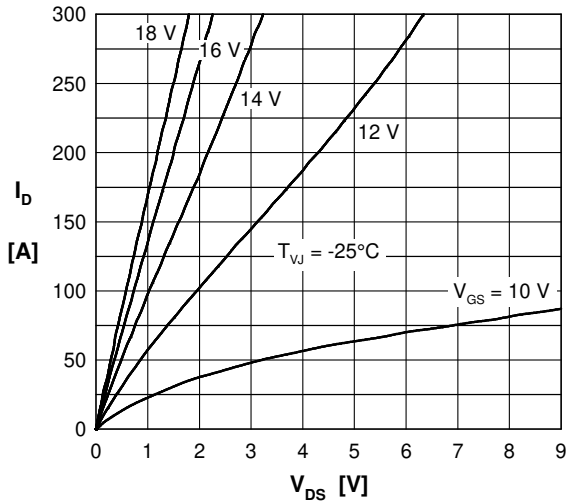


Fig. 1 Typical output characteristics ( $-25^{\circ}\text{C}$ )

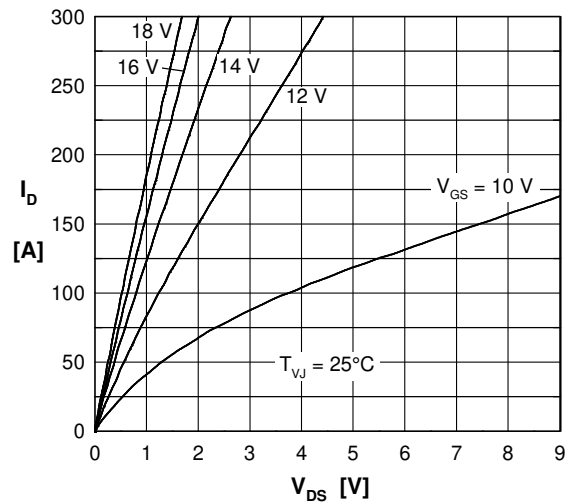


Fig. 2 Typical output characteristics ( $25^{\circ}\text{C}$ )

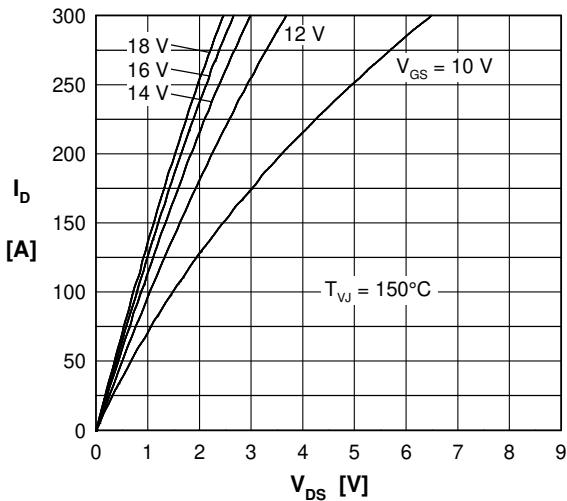


Fig. 3 Typical output characteristics ( $150^{\circ}\text{C}$ )

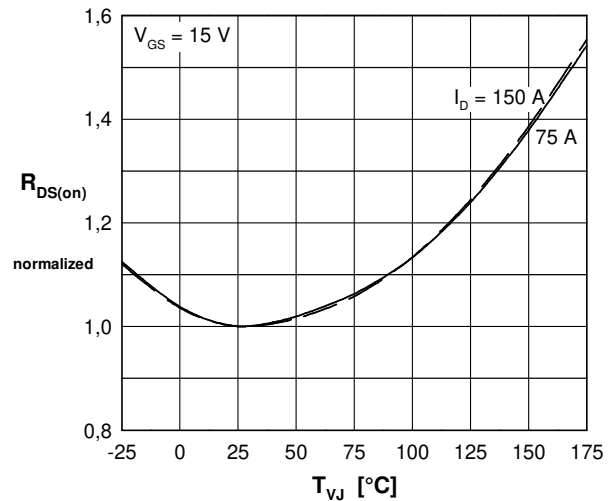


Fig. 4  $R_{DS(on)}$  normalized vs. junction temperature  $T_{VJ}$

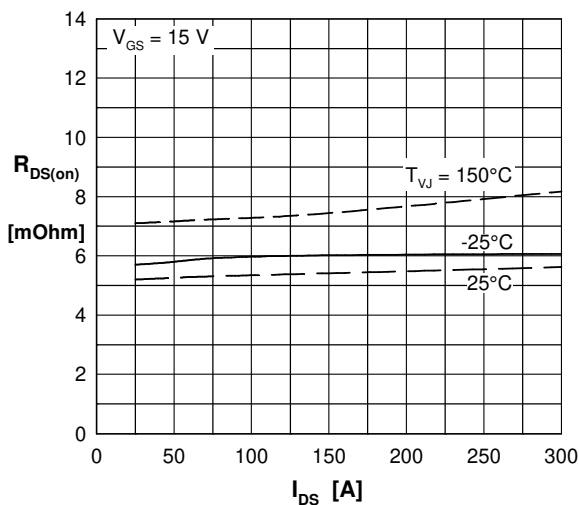


Fig. 5  $R_{DS(on)}$  versus drain current

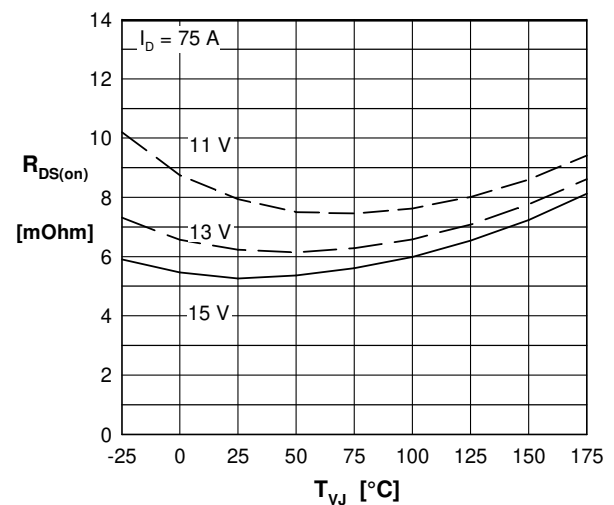


Fig. 6  $R_{DS(on)}$  versus junction temperature  $T_{VJ}$

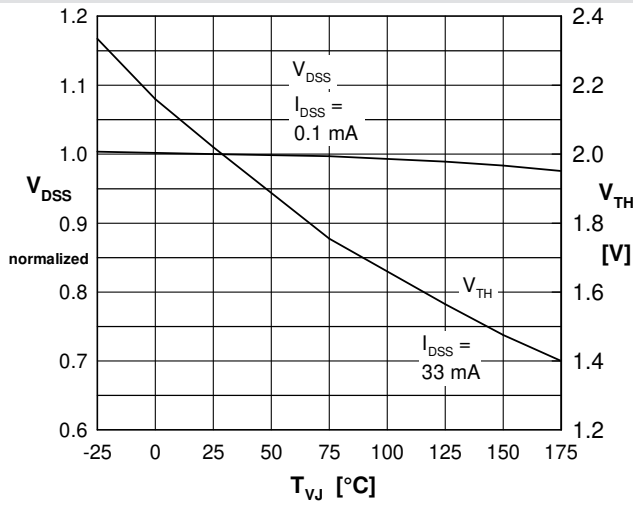
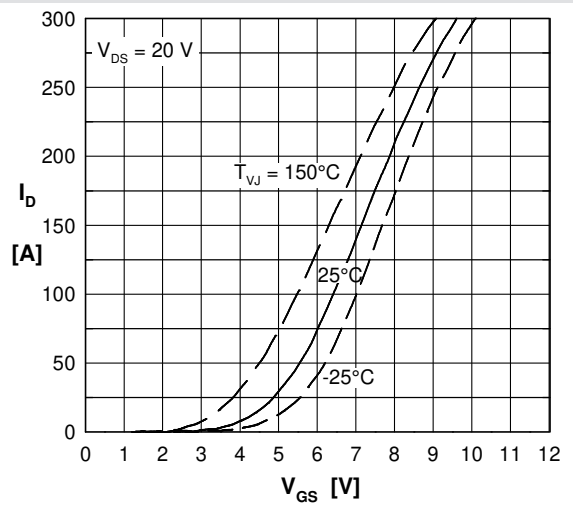
**Curves**

 Fig. 7 Norm. breakdown  $V_{DSS}$  & threshold voltage  $V_{TH}$  versus junction temperature  $T_{VJ}$ 


Fig. 8 Typical transfer characteristics

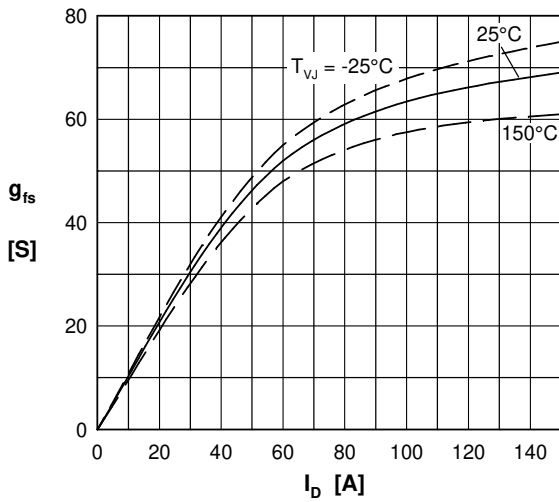
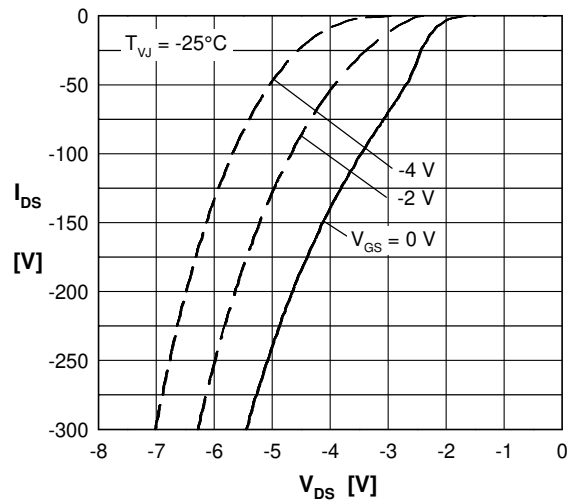
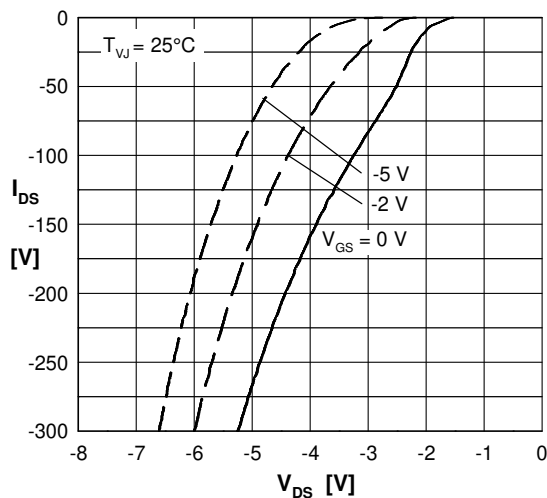
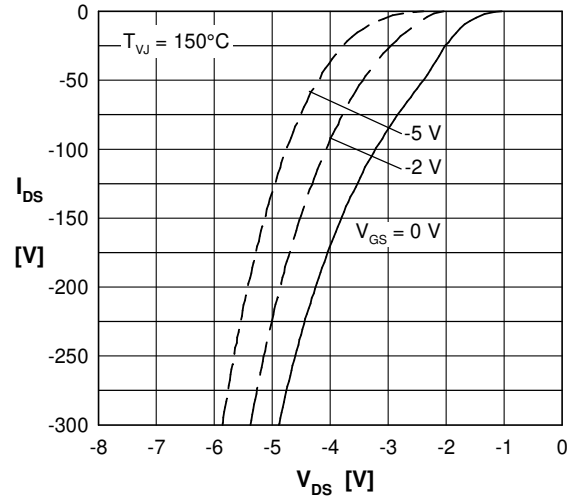


Fig. 9 Typical forward transconductance


 Fig. 10 Forward voltage drop of intrinsic diode versus  $V_{DS}$  measured at  $-55^{\circ}\text{C}$ 

 Fig. 11 Forward voltage drop of intrinsic diode versus  $V_{DS}$  measured at  $25^{\circ}\text{C}$ 

 Fig. 12 Forward voltage drop of intrinsic diode versus  $V_{DS}$  measured at  $150^{\circ}\text{C}$

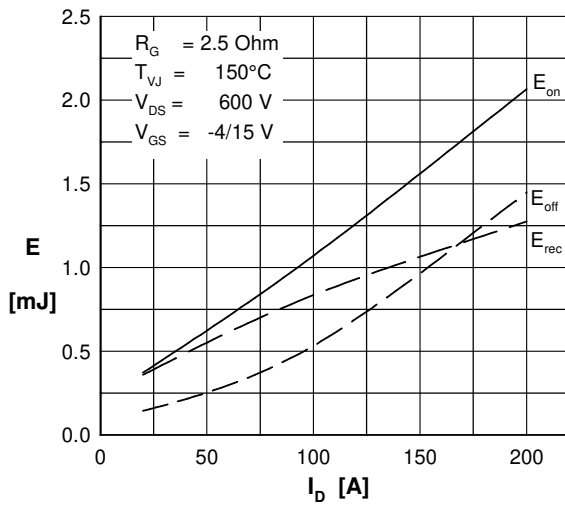
**Curves**


Fig. 13 Typical switching energy versus drain current

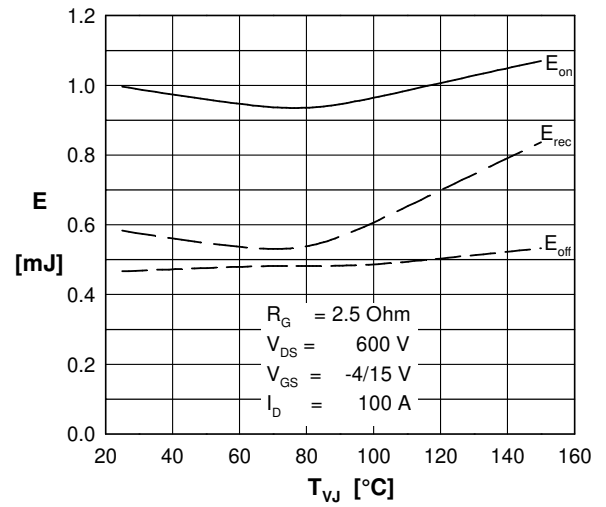


Fig. 14 Typical switching energy versus temperature

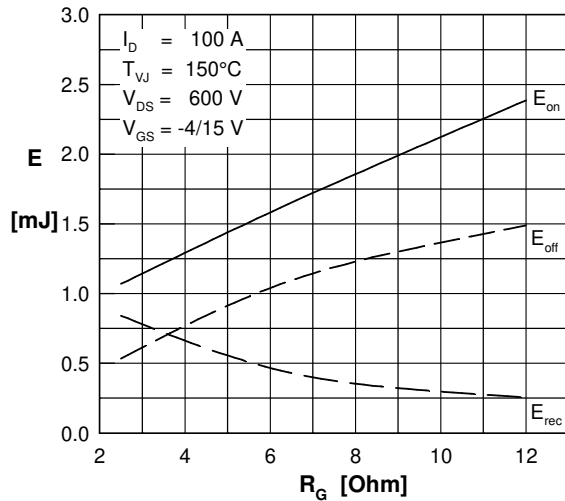


Fig. 15 Typical switching energy versus external gate resistor

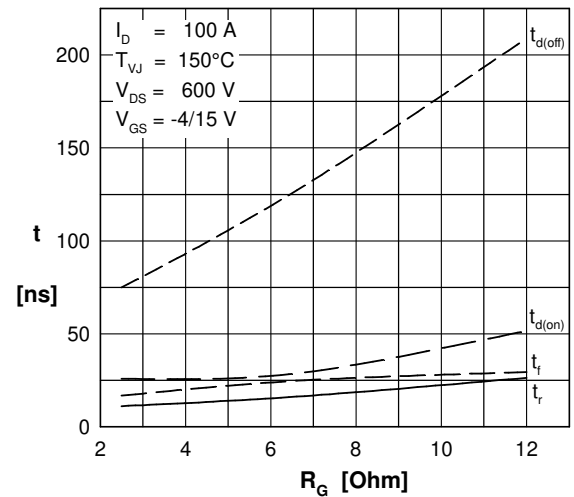


Fig. 16 Typical switching time versus external gate resistor

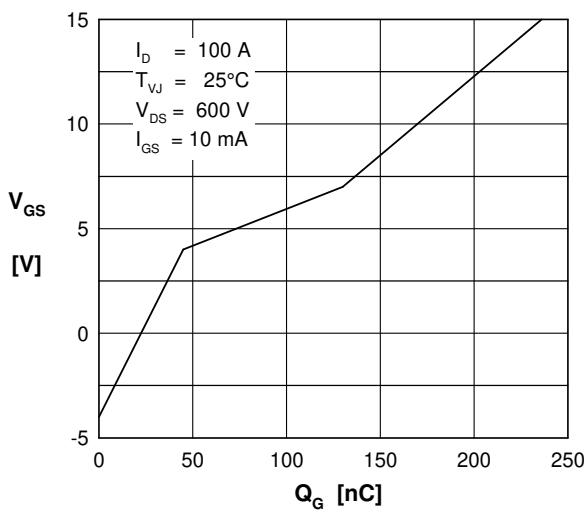


Fig. 17 Typical turn on gate charge, trendline

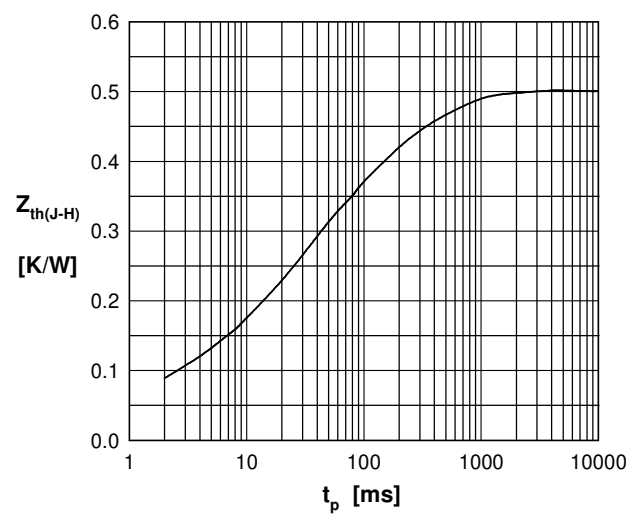


Fig. 18 Typical transient thermal impedance