

# Breakover Diode Modules (BOD1)

 $V_{BO} = 1200 - 4200 \text{ V}$   
 $I_{AVM} = 0.2 - 1.25 \text{ A}$ 

Number of BODs	Types
2	IXBOD1-12R(D) ... IXBOD1-19R(D)
3	IXBOD1-20R(D) ... IXBOD1-32R(D)
4	IXBOD1-34R ... IXBOD1-42R

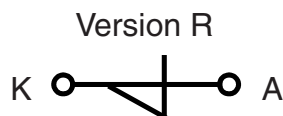
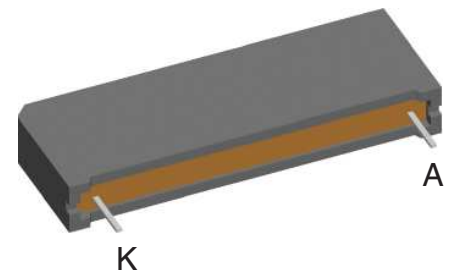

### Features / Advantages:

- Fast turn on
- Low temperature dependence
- Low leakage current

### Applications:

- High voltage circuit protection
- Transient voltage protection
- Trigger device
- Power pulse generators
- Lightning and arcing protection
- Energy discharge circuits
- Battery overvoltage protection
- Solar array protection

### Package: BOD-Package

- Industry standard outline
- RoHS compliant
- Epoxy meets UL 94V-0
- Soldering pins for PCB mounting
- Reduced weight

### Disclaimer Notice

Information furnished is believed to be accurate and reliable. However, users should independently evaluate the suitability of and test each product selected for their own applications. Littelfuse products are not designed for, and may not be used in, all applications. Read complete Disclaimer Notice Disclaimer Notice at [www.littelfuse.com/disclaimer-electronics](http://www.littelfuse.com/disclaimer-electronics).

IXBOD1 several values				Ratings			
Symbol	Definitions	Conditions	min.	typ.	max.		
$I_D$	drain current	$V_D = 0.8 \cdot V_{BO}$ $T_{VJ} = 125^\circ\text{C}$			100	$\mu\text{A}$	
$I_{BO}$	breakover current	$T_{VJ} = 25^\circ\text{C}$			15	$\text{mA}$	
$I_H$	holding current	$T_{VJ} = 25^\circ\text{C}$			30	$\text{mA}$	
$V_H$	holding voltage	$T_{VJ} = 25^\circ\text{C}$	4		8	$\text{V}$	
$(di/dt)_C$	maximum pulsed source current	$V_D = V_{BO}; I_T = 80 \text{ A}; f = 50 \text{ Hz}$ $T_{VJ} = 125^\circ\text{C}$			200	$\text{A}/\mu\text{s}$	
$t_q$	turn-off time	$V_D = 0.67 \cdot V_{BO}; V_R = 0 \text{ V}; I_T = 80 \text{ A}$ $T_{VJ} = 125^\circ\text{C}$ $dv/dt_{(lin.)} = 200 \text{ V}/\mu\text{s}; di/dt = -10 \text{ A}/\mu\text{s}$		150		$\mu\text{s}$	
$K_T$	temperature coefficient of $V_{BO}$				$2 \cdot 10^{-3}$	$\text{K}^{-1}$	
$K_P$	coefficient for energy per pulse $E_P$	(material constant)			700	$\text{K}/\text{Ws}$	

IXBOD1 - 12R... - 19R (2 Elements)				Ratings			
Symbol	Definitions	Conditions	min.	typ.	max.		
$V_{BO}$	breakover voltage	$V_{BO}(T_{VJ}) = V_{BO, 25^\circ\text{C}} [1 + K_T (T_{VJ} - 25^\circ\text{C})]$ IXBOD 1 -12R IXBOD 1 -13R IXBOD 1 -14R IXBOD 1 -15R IXBOD 1 -16R IXBOD 1 -17R IXBOD 1 -18R IXBOD 1 -19R	1150 1250 1350 1450 1550 1650 1750 1850	1200 1300 1400 1500 1600 1700 1800 1900	1250 1350 1450 1550 1650 1750 1850 1950	$\text{V}$ $\text{V}$ $\text{V}$ $\text{V}$ $\text{V}$ $\text{V}$ $\text{V}$ $\text{V}$	
$I_{RMS}$	RMS current	$f = 50 \text{ Hz}$ $T_{amb} = 50^\circ\text{C}$ pins soldered to printed circuit (conductor 0.035x2mm)			2.0	$\text{A}$	
$I_{FAVM}$	maximum average forward current				1.25	$\text{A}$	
$I_{SM}$	maximum pulsed source current	$t_p = 0.1 \text{ ms};$ non repetitive $T_{amb} = 50^\circ\text{C}$			200	$\text{A}$	
$I^2t$	$I^2t$ value for fusing	$t_p = 0.1 \text{ ms}$ $T_{amb} = 50^\circ\text{C}$			2	$\text{A}^2\text{s}$	
$V_T$	forward voltage drop	$I_T = 5 \text{ A}$ $T_{VJ} = 125^\circ\text{C}$			3.4	$\text{V}$	
$V_{T0}$	threshold voltage	for power-loss calculation only			2.2	$\text{V}$	
$r_T$	slope resistance				0.24	$\Omega$	

IXBOD1 - 12RD... - 19RD (2 Elements)				Ratings			
Symbol	Definitions	Conditions	min.	typ.	max.		
$V_{BO}$	<i>breakover voltage</i>	$V_{BO}(T_{VJ}) = V_{BO, 25^{\circ}C} [1 + K_T (T_{VJ} - 25^{\circ}C)]$ IXBOD 1 -12RD IXBOD 1 -13RD IXBOD 1 -14RD IXBOD 1 -15RD IXBOD 1 -16RD IXBOD 1 -17RD IXBOD 1 -18RD IXBOD 1 -19RD					
			1150	1200	1250	V	
			1250	1300	1350	V	
			1350	1400	1450	V	
			1450	1500	1550	V	
			1550	1600	1650	V	
			1650	1700	1750	V	
			1750	1800	1850	V	
		1850	1900	1950	V		
$I_{RMS}$	<i>RMS current</i>	f = 50 Hz pins soldered to printed circuit (conductor 0.035x2mm)			0.3		A
$I_{FAVM}$	<i>maximum average forward current</i>				0.2		A
$I_{SM}$	<i>maximum pulsed source current</i>	$t_p = 0.1$ ms; non repetitive			50		A
$I^2t$	<i>I<sup>2</sup>t value for fusing</i>	$t_p = 0.1$ ms			0.125		A <sup>2</sup> s
$V_T$	<i>forward voltage drop</i>	$I_T = 5$ A			27		V
$V_{TO}$	<i>threshold voltage</i>	for power-loss calculation only			17.5		V
$r_T$	<i>slope resistance</i>				3		$\Omega$

IXBOD1 - 20R... - 32R (3 Elements)				Ratings			
Symbol	Definitions	Conditions	min.	typ.	max.		
$V_{BO}$	<i>breakover voltage</i>	$V_{BO}(T_{VJ}) = V_{BO, 25^{\circ}C} [1 + K_T (T_{VJ} - 25^{\circ}C)]$ IXBOD 1 -20R IXBOD 1 -21R IXBOD 1 -22R IXBOD 1 -23R IXBOD 1 -24R IXBOD 1 -25R IXBOD 1 -26R IXBOD 1 -28R IXBOD 1 -30R IXBOD 1 -32R					
			1950	2000	2050	V	
			2050	2100	2150	V	
			2150	2200	2250	V	
			2250	2300	2350	V	
			2350	2400	2450	V	
			2450	2500	2550	V	
			2500	2600	2700	V	
			2700	2800	2900	V	
			2900	3000	3100	V	
		3100	3200	3300	V		
$I_{RMS}$	<i>RMS current</i>	f = 50 Hz pins soldered to printed circuit (conductor 0.035x2mm)			1.4		A
$I_{FAVM}$	<i>maximum average forward current</i>				0.9		A
$I_{SM}$	<i>maximum pulsed source current</i>	$t_p = 0.1$ ms; non repetitive			200		A
$I^2t$	<i>I<sup>2</sup>t value for fusing</i>	$t_p = 0.1$ ms			2		A <sup>2</sup> s
$V_T$	<i>forward voltage drop</i>	$I_T = 5$ A			5.1		V
$V_{TO}$	<i>threshold voltage</i>	for power-loss calculation only			3.3		V
$r_T$	<i>slope resistance</i>				0.36		$\Omega$

IXBOD1 - 20RD... - 32RD (3 Elements)			Ratings			
Symbol	Definitions	Conditions	min.	typ.	max.	
$V_{BO}$	<i>breakover voltage</i>	$V_{BO}(T_{VJ}) = V_{BO, 25^{\circ}C} [1 + K_T (T_{VJ} - 25^{\circ}C)]$ IXBOD 1 -20RD IXBOD 1 -21RD IXBOD 1 -22RD IXBOD 1 -23RD IXBOD 1 -24RD IXBOD 1 -25RD IXBOD 1 -26RD IXBOD 1 -28RD IXBOD 1 -30RD IXBOD 1 -32RD				
			1950	2000	2050	V
			2050	2100	2150	V
			2150	2200	2250	V
			2250	2300	2350	V
			2350	2400	2450	V
			2450	2500	2550	V
			2500	2600	2700	V
			2700	2800	2900	V
			2900	3000	3100	V
3100	3200	3300	V			
$I_{RMS}$	<i>RMS current</i>	f = 50 Hz pins soldered to printed circuit (conductor 0.035x2mm)			0.3	A
$I_{FAVM}$	<i>maximum average forward current</i>				0.2	A
$I_{SM}$	<i>maximum pulsed source current</i>	$t_p = 0.1$ ms; non repetitive			50	A
$I^2t$	<i>I<sup>2</sup>t value for fusing</i>	$t_p = 0.1$ ms			0.125	A <sup>2</sup> s
$V_T$	<i>forward voltage drop</i>	$I_T = 5$ A			27	V
$V_{T0}$	<i>threshold voltage</i>	for power-loss calculation only			17.5	V
$r_T$	<i>slope resistance</i>				3	$\Omega$

IXBOD1 - 34... - 42R (4 Elements)			Ratings			
Symbol	Definitions	Conditions	min.	typ.	max.	
$V_{BO}$	<i>breakover voltage</i>	$V_{BO}(T_{VJ}) = V_{BO, 25^{\circ}C} [1 + K_T (T_{VJ} - 25^{\circ}C)]$ IXBOD 1 -34R IXBOD 1 -36R IXBOD 1 -38R IXBOD 1 -40R IXBOD 1 -42R				
			3300	3400	3500	V
			3500	3600	3700	V
			3700	3800	4000	V
			3900	4000	4100	V
			4100	4200	4300	V
$I_{RMS}$	<i>RMS current</i>	f = 50 Hz pins soldered to printed circuit (conductor 0.035x2mm)			1.1	A
$I_{FAVM}$	<i>maximum average forward current</i>				0.7	A
$I_{SM}$	<i>maximum pulsed source current</i>	$t_p = 0.1$ ms; non repetitive			200	A
$I^2t$	<i>I<sup>2</sup>t value for fusing</i>	$t_p = 0.1$ ms			2	A <sup>2</sup> s
$V_T$	<i>forward voltage drop</i>	$I_T = 5$ A			6.8	V
$V_{T0}$	<i>threshold voltage</i>	for power-loss calculation only			4.4	V
$r_T$	<i>slope resistance</i>				0.48	$\Omega$

Package FP-Case				Ratings		
Symbol	Definitions	Conditions	min.	typ.	max.	
$T_{amb}$	ambient temperature (cooling medium)		-40		125	°C
$T_{stg}$	storage temperature		-40		125	°C
$T_{vJM}$	maximum virtual junction temperature		-40		125	°C
$R_{thJA}$	thermal resistance junction to ambient	natural convection			20	K/W
		with air speed 2 m/s			16	K/W
<b>Weight</b>				14		g

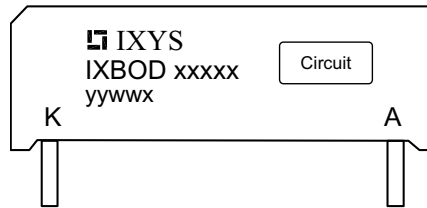
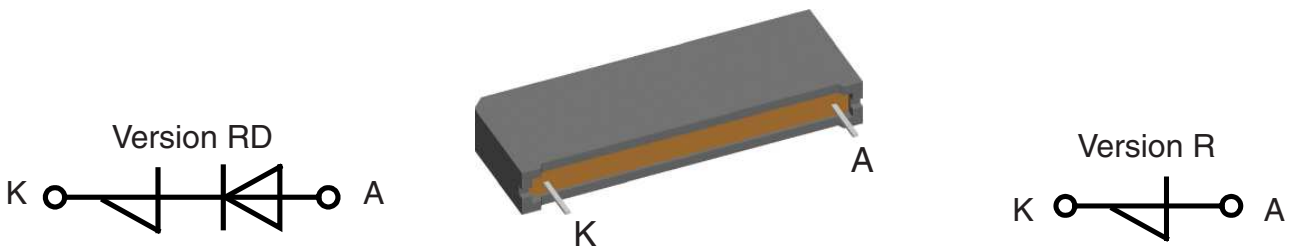
**Outlines FP-case**

Dimensions in mm (1 mm = 0.0394")

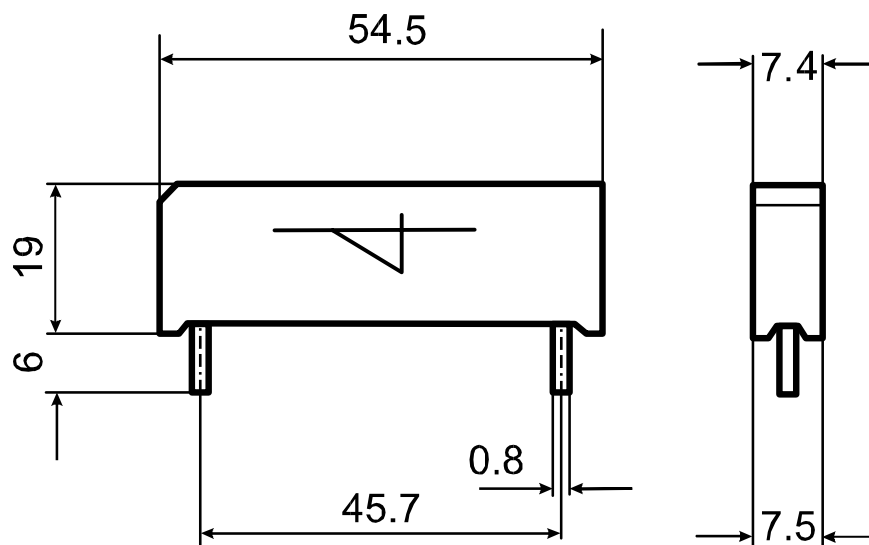

Ordering	Part Name	Marking on Product	Delivering Mode	Base Qty	Ordering Code
Standard	IXBOD 1 -12R	IXBOD 1 -12R	Box	20	468649
Standard	IXBOD 1 -12RD	IXBOD 1 -12RD	Box	20	472948
Standard	IXBOD 1 -13R	IXBOD 1 -13R	Box	20	468657
Standard	IXBOD 1 -13RD	IXBOD 1 -13RD	Box	20	472956
Standard	IXBOD 1 -14R	IXBOD 1 -14R	Box	20	468665
Standard	IXBOD 1 -14RD	IXBOD 1 -14RD	Box	20	472964
Standard	IXBOD 1 -15R	IXBOD 1 -15R	Box	20	468673
Standard	IXBOD 1 -15RD	IXBOD 1 -15RD	Box	20	472972
Standard	IXBOD 1 -16R	IXBOD 1 -16R	Box	20	468681
Standard	IXBOD 1 -16RD	IXBOD 1 -16RD	Box	20	472794
Standard	IXBOD 1 -17R	IXBOD 1 -17R	Box	20	468703
Standard	IXBOD 1 -17RD	IXBOD 1 -17RD	Box	20	472980
Standard	IXBOD 1 -18R	IXBOD 1 -18R	Box	20	468711
Standard	IXBOD 1 -18RD	IXBOD 1 -18RD	Box	20	472999
Standard	IXBOD 1 -19R	IXBOD 1 -19R	Box	20	468738
Standard	IXBOD 1 -19RD	IXBOD 1 -19RD	Box	20	473006
Standard	IXBOD 1 -20R	IXBOD 1 -20R	Box	20	468746
Standard	IXBOD 1 -20RD	IXBOD 1 -20RD	Box	20	473014
Standard	IXBOD 1 -21R	IXBOD 1 -21R	Box	20	468754
Standard	IXBOD 1 -21RD	IXBOD 1 -21RD	Box	20	473022
Standard	IXBOD 1 -22R	IXBOD 1 -22R	Box	20	468762
Standard	IXBOD 1 -22RD	IXBOD 1 -22RD	Box	20	473030
Standard	IXBOD 1 -23R	IXBOD 1 -23R	Box	20	468770
Standard	IXBOD 1 -23RD	IXBOD 1 -23RD	Box	20	472786
Standard	IXBOD 1 -24R	IXBOD 1 -24R	Box	20	468789
Standard	IXBOD 1 -24RD	IXBOD 1 -24RD	Box	20	473049
Standard	IXBOD 1 -25R	IXBOD 1 -25R	Box	20	468797
Standard	IXBOD 1 -25RD	IXBOD 1 -25RD	Box	20	473057
Standard	IXBOD 1 -26R	IXBOD 1 -26R	Box	20	468800
Standard	IXBOD 1 -26RD	IXBOD 1 -26RD	Box	20	473065
Standard	IXBOD 1 -28R	IXBOD 1 -28R	Box	20	468819
Standard	IXBOD 1 -28RD	IXBOD 1 -28RD	Box	20	473073
Standard	IXBOD 1 -30R	IXBOD 1 -30R	Box	20	468827
Standard	IXBOD 1 -30RD	IXBOD 1 -30RD	Box	20	473081
Standard	IXBOD 1 -32R	IXBOD 1 -32R	Box	20	468835
Standard	IXBOD 1 -32RD	IXBOD 1 -32RD	Box	20	473103
Standard	IXBOD 1 -34R	IXBOD 1 -34R	Box	20	468843
Standard	IXBOD 1 -36R	IXBOD 1 -36R	Box	20	468851
Standard	IXBOD 1 -38R	IXBOD 1 -38R	Box	20	468878
Standard	IXBOD 1 -40R	IXBOD 1 -40R	Box	20	468886
Standard	IXBOD 1 -42R	IXBOD 1 -42R	Box	20	468894

**Curves**

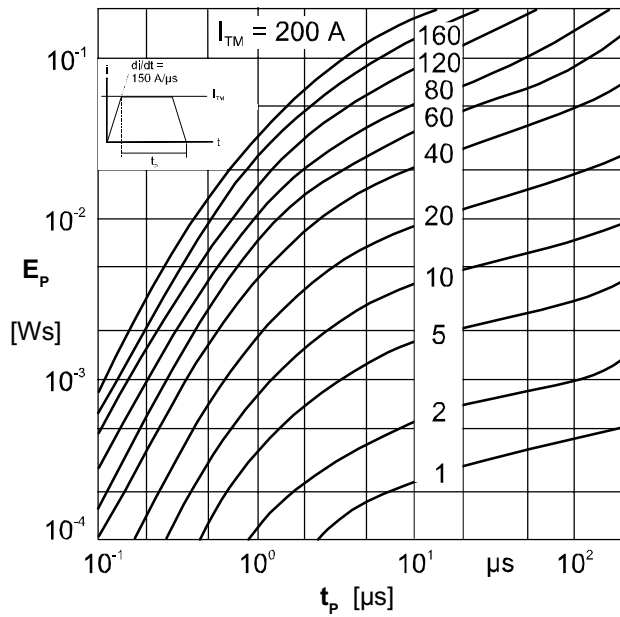

Fig. 1 Energy per pulse for single BOD element for trapezoidal wave current.  $E_p$  must be multiplied by number of elements for total energy

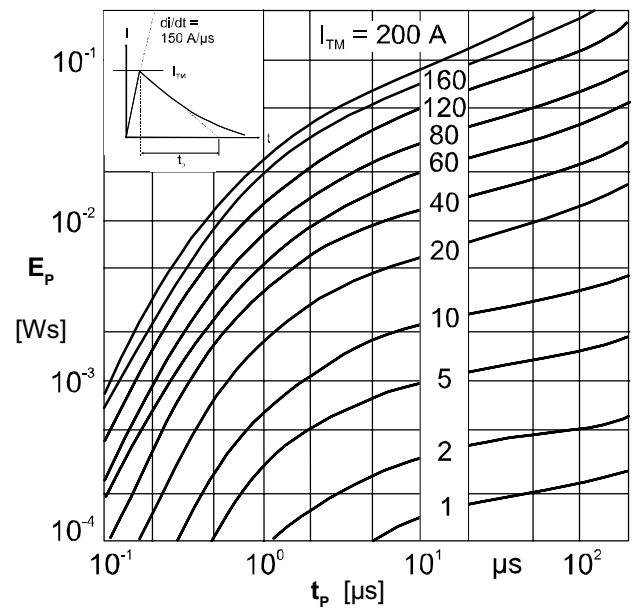

Fig. 2 Energy per pulse for single BOD element for exponentially decaying current pulse.  $E_p$  must be multiplied by number of elements for total energy

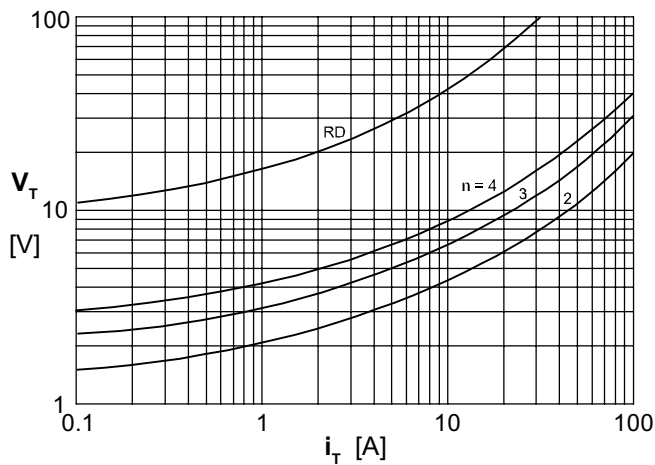

Fig. 3 On-state voltage at  $T_{vj} = 125^\circ\text{C}$

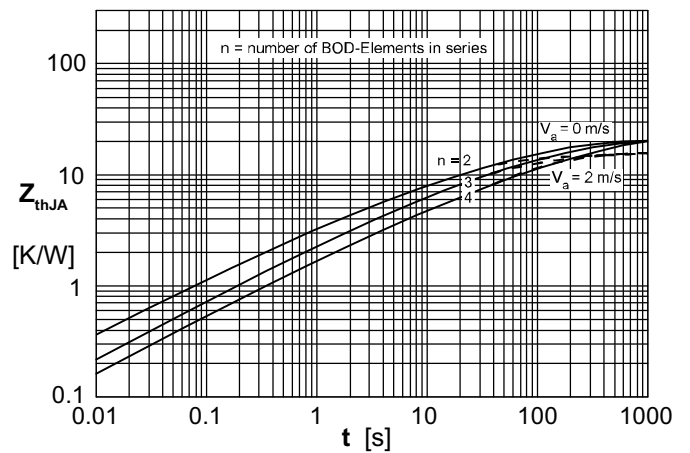

Fig. 4 Transient thermal resistance