

Breakover Diode Modules (BOD1)

 $V_{BO} = 1200 - 4200 \text{ V}$
 $I_{AVM} = 0.2 - 1.25 \text{ A}$

| Number of BODs | Types |
|----------------|---------------------------------|
| 2 | IXBOD1-12R(D) ... IXBOD1-19R(D) |
| 3 | IXBOD1-20R(D) ... IXBOD1-32R(D) |
| 4 | IXBOD1-34R ... IXBOD1-42R |

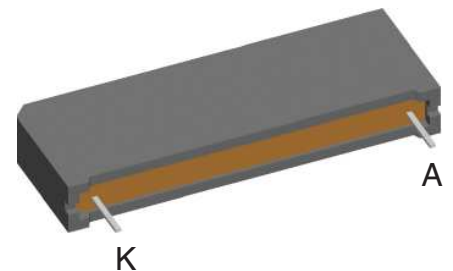

Features / Advantages:

- Fast turn on
- Low temperature dependence
- Low leakage current

Applications:

- High voltage circuit protection
- Transient voltage protection
- Trigger device
- Power pulse generators
- Lightning and arcing protection
- Energy discharge circuits
- Battery overvoltage protection
- Solar array protection

Package: BOD-Package

- Industry standard outline
- RoHS compliant
- Epoxy meets UL 94V-0
- Soldering pins for PCB mounting
- Reduced weight

Disclaimer Notice

Information furnished is believed to be accurate and reliable. However, users should independently evaluate the suitability of and test each product selected for their own applications. Littelfuse products are not designed for, and may not be used in, all applications. Read complete Disclaimer Notice Disclaimer Notice at www.littelfuse.com/disclaimer-electronics.

| IXBOD1 several values | | | | Ratings | | | |
|-----------------------|--|--|------|---------|-------------------|------------------------|--|
| Symbol | Definitions | Conditions | min. | typ. | max. | | |
| I_D | drain current | $V_D = 0.8 \cdot V_{BO}$ $T_{VJ} = 125^\circ\text{C}$ | | | 100 | μA | |
| I_{BO} | breakover current | $T_{VJ} = 25^\circ\text{C}$ | | | 15 | mA | |
| I_H | holding current | $T_{VJ} = 25^\circ\text{C}$ | | | 30 | mA | |
| V_H | holding voltage | $T_{VJ} = 25^\circ\text{C}$ | 4 | | 8 | V | |
| $(di/dt)_C$ | maximum pulsed source current | $V_D = V_{BO}; I_T = 80 \text{ A}; f = 50 \text{ Hz}$ $T_{VJ} = 125^\circ\text{C}$ | | | 200 | $\text{A}/\mu\text{s}$ | |
| t_q | turn-off time | $V_D = 0.67 \cdot V_{BO}; V_R = 0 \text{ V}; I_T = 80 \text{ A}$ $T_{VJ} = 125^\circ\text{C}$ $dv/dt_{(lin.)} = 200 \text{ V}/\mu\text{s}; di/dt = -10 \text{ A}/\mu\text{s}$ | | 150 | | μs | |
| K_T | temperature coefficient of V_{BO} | | | | $2 \cdot 10^{-3}$ | K^{-1} | |
| K_P | coefficient for energy per pulse E_P | (material constant) | | | 700 | K/Ws | |

| IXBOD1 - 12R... - 19R (2 Elements) | | | | Ratings | | | |
|------------------------------------|---------------------------------|---|--|--|--|--|--|
| Symbol | Definitions | Conditions | min. | typ. | max. | | |
| V_{BO} | breakover voltage | $V_{BO}(T_{VJ}) = V_{BO, 25^\circ\text{C}} [1 + K_T (T_{VJ} - 25^\circ\text{C})]$ IXBOD 1 -12R IXBOD 1 -13R IXBOD 1 -14R IXBOD 1 -15R IXBOD 1 -16R IXBOD 1 -17R IXBOD 1 -18R IXBOD 1 -19R | 1150 1250 1350 1450 1550 1650 1750 1850 | 1200 1300 1400 1500 1600 1700 1800 1900 | 1250 1350 1450 1550 1650 1750 1850 1950 | V V V V V V V V | |
| I_{RMS} | RMS current | $f = 50 \text{ Hz}$ $T_{amb} = 50^\circ\text{C}$ pins soldered to printed circuit (conductor 0.035x2mm) | | | 2.0 | A | |
| I_{FAVM} | maximum average forward current | | | | 1.25 | A | |
| I_{SM} | maximum pulsed source current | $t_p = 0.1 \text{ ms};$ non repetitive $T_{amb} = 50^\circ\text{C}$ | | | 200 | A | |
| I^2t | I^2t value for fusing | $t_p = 0.1 \text{ ms}$ $T_{amb} = 50^\circ\text{C}$ | | | 2 | A^2s | |
| V_T | forward voltage drop | $I_T = 5 \text{ A}$ $T_{VJ} = 125^\circ\text{C}$ | | | 3.4 | V | |
| V_{T0} | threshold voltage | | | | 2.2 | V | |
| r_T | slope resistance | for power-loss calculation only | | | 0.24 | Ω | |

| IXBOD1 - 12RD... - 19RD (2 Elements) | | | | Ratings | | | |
|--------------------------------------|--|---|------|---------|-------|---|------------------|
| Symbol | Definitions | Conditions | min. | typ. | max. | | |
| V_{BO} | <i>breakover voltage</i> | $V_{BO}(T_{VJ}) = V_{BO, 25^{\circ}C} [1 + K_T (T_{VJ} - 25^{\circ}C)]$ IXBOD 1 -12RD IXBOD 1 -13RD IXBOD 1 -14RD IXBOD 1 -15RD IXBOD 1 -16RD IXBOD 1 -17RD IXBOD 1 -18RD IXBOD 1 -19RD | | | | | |
| | | | 1150 | 1200 | 1250 | V | |
| | | | 1250 | 1300 | 1350 | V | |
| | | | 1350 | 1400 | 1450 | V | |
| | | | 1450 | 1500 | 1550 | V | |
| | | | 1550 | 1600 | 1650 | V | |
| | | | 1650 | 1700 | 1750 | V | |
| | | | 1750 | 1800 | 1850 | V | |
| | | 1850 | 1900 | 1950 | V | | |
| I_{RMS} | <i>RMS current</i> | f = 50 Hz pins soldered to printed circuit (conductor 0.035x2mm) | | | 0.3 | | A |
| I_{FAVM} | <i>maximum average forward current</i> | | | | 0.2 | | A |
| I_{SM} | <i>maximum pulsed source current</i> | $t_p = 0.1$ ms; non repetitive | | | 50 | | A |
| I^2t | <i>I²t value for fusing</i> | $t_p = 0.1$ ms | | | 0.125 | | A ² s |
| V_T | <i>forward voltage drop</i> | $I_T = 5$ A | | | 27 | | V |
| V_{TO} | <i>threshold voltage</i> | for power-loss calculation only | | | 17.5 | | V |
| r_T | <i>slope resistance</i> | | | | 3 | | Ω |

| IXBOD1 - 20R... - 32R (3 Elements) | | | | Ratings | | | |
|------------------------------------|--|---|------|---------|------|---|------------------|
| Symbol | Definitions | Conditions | min. | typ. | max. | | |
| V_{BO} | <i>breakover voltage</i> | $V_{BO}(T_{VJ}) = V_{BO, 25^{\circ}C} [1 + K_T (T_{VJ} - 25^{\circ}C)]$ IXBOD 1 -20R IXBOD 1 -21R IXBOD 1 -22R IXBOD 1 -23R IXBOD 1 -24R IXBOD 1 -25R IXBOD 1 -26R IXBOD 1 -28R IXBOD 1 -30R IXBOD 1 -32R | | | | | |
| | | | 1950 | 2000 | 2050 | V | |
| | | | 2050 | 2100 | 2150 | V | |
| | | | 2150 | 2200 | 2250 | V | |
| | | | 2250 | 2300 | 2350 | V | |
| | | | 2350 | 2400 | 2450 | V | |
| | | | 2450 | 2500 | 2550 | V | |
| | | | 2500 | 2600 | 2700 | V | |
| | | | 2700 | 2800 | 2900 | V | |
| | | | 2900 | 3000 | 3100 | V | |
| | | 3100 | 3200 | 3300 | V | | |
| I_{RMS} | <i>RMS current</i> | f = 50 Hz pins soldered to printed circuit (conductor 0.035x2mm) | | | 1.4 | | A |
| I_{FAVM} | <i>maximum average forward current</i> | | | | 0.9 | | A |
| I_{SM} | <i>maximum pulsed source current</i> | $t_p = 0.1$ ms; non repetitive | | | 200 | | A |
| I^2t | <i>I²t value for fusing</i> | $t_p = 0.1$ ms | | | 2 | | A ² s |
| V_T | <i>forward voltage drop</i> | $I_T = 5$ A | | | 5.1 | | V |
| V_{TO} | <i>threshold voltage</i> | for power-loss calculation only | | | 3.3 | | V |
| r_T | <i>slope resistance</i> | | | | 0.36 | | Ω |

| IXBOD1 - 20RD... - 32RD (3 Elements) | | | Ratings | | | |
|--------------------------------------|--|---|---------|------|-------|------------------|
| Symbol | Definitions | Conditions | min. | typ. | max. | |
| V_{BO} | <i>breakover voltage</i> | $V_{BO}(T_{VJ}) = V_{BO, 25^{\circ}C} [1 + K_T (T_{VJ} - 25^{\circ}C)]$ IXBOD 1 -20RD IXBOD 1 -21RD IXBOD 1 -22RD IXBOD 1 -23RD IXBOD 1 -24RD IXBOD 1 -25RD IXBOD 1 -26RD IXBOD 1 -28RD IXBOD 1 -30RD IXBOD 1 -32RD | | | | |
| | | | 1950 | 2000 | 2050 | V |
| | | | 2050 | 2100 | 2150 | V |
| | | | 2150 | 2200 | 2250 | V |
| | | | 2250 | 2300 | 2350 | V |
| | | | 2350 | 2400 | 2450 | V |
| | | | 2450 | 2500 | 2550 | V |
| | | | 2500 | 2600 | 2700 | V |
| | | | 2700 | 2800 | 2900 | V |
| | | | 2900 | 3000 | 3100 | V |
| 3100 | 3200 | 3300 | V | | | |
| I_{RMS} | <i>RMS current</i> | $f = 50 \text{ Hz}$ $T_{amb} = 50^{\circ}C$ pins soldered to printed circuit (conductor 0.035x2mm) | | | 0.3 | A |
| I_{FAVM} | <i>maximum average forward current</i> | | | | 0.2 | A |
| I_{SM} | <i>maximum pulsed source current</i> | $t_p = 0.1 \text{ ms; non repetitive}$ $T_{amb} = 50^{\circ}C$ | | | 50 | A |
| I^2t | <i>I²t value for fusing</i> | $t_p = 0.1 \text{ ms}$ $T_{amb} = 50^{\circ}C$ | | | 0.125 | A ² s |
| V_T | <i>forward voltage drop</i> | $I_T = 5 \text{ A}$ $T_{VJ} = 125^{\circ}C$ | | | 27 | V |
| V_{T0} | <i>threshold voltage</i> | for power-loss calculation only | | | 17.5 | V |
| r_T | <i>slope resistance</i> | | | | 3 | Ω |

| IXBOD1 - 34... - 42R (4 Elements) | | | Ratings | | | |
|-----------------------------------|--|---|---------|------|------|------------------|
| Symbol | Definitions | Conditions | min. | typ. | max. | |
| V_{BO} | <i>breakover voltage</i> | $V_{BO}(T_{VJ}) = V_{BO, 25^{\circ}C} [1 + K_T (T_{VJ} - 25^{\circ}C)]$ IXBOD 1 -34R IXBOD 1 -36R IXBOD 1 -38R IXBOD 1 -40R IXBOD 1 -42R | | | | |
| | | | 3300 | 3400 | 3500 | V |
| | | | 3500 | 3600 | 3700 | V |
| | | | 3700 | 3800 | 4000 | V |
| | | | 3900 | 4000 | 4100 | V |
| | | | 4100 | 4200 | 4300 | V |
| I_{RMS} | <i>RMS current</i> | $f = 50 \text{ Hz}$ $T_{amb} = 50^{\circ}C$ pins soldered to printed circuit (conductor 0.035x2mm) | | | 1.1 | A |
| I_{FAVM} | <i>maximum average forward current</i> | | | | 0.7 | A |
| I_{SM} | <i>maximum pulsed source current</i> | $t_p = 0.1 \text{ ms; non repetitive}$ $T_{amb} = 50^{\circ}C$ | | | 200 | A |
| I^2t | <i>I²t value for fusing</i> | $t_p = 0.1 \text{ ms}$ $T_{amb} = 50^{\circ}C$ | | | 2 | A ² s |
| V_T | <i>forward voltage drop</i> | $I_T = 5 \text{ A}$ $T_{VJ} = 125^{\circ}C$ | | | 6.8 | V |
| V_{T0} | <i>threshold voltage</i> | for power-loss calculation only | | | 4.4 | V |
| r_T | <i>slope resistance</i> | | | | 0.48 | Ω |

| Package FP-Case | | | | Ratings | | |
|-----------------|--|----------------------|------|---------|------|-----|
| Symbol | Definitions | Conditions | min. | typ. | max. | |
| T_{amb} | ambient temperature (cooling medium) | | -40 | | 125 | °C |
| T_{stg} | storage temperature | | -40 | | 125 | °C |
| T_{vJM} | maximum virtual junction temperature | | -40 | | 125 | °C |
| R_{thJA} | thermal resistance junction to ambient | natural convection | | | 20 | K/W |
| | | with air speed 2 m/s | | | 16 | K/W |
| Weight | | | | 14 | | g |

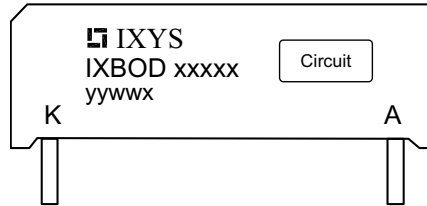

Outlines FP-case



Dimensions in mm (1 mm = 0.0394")

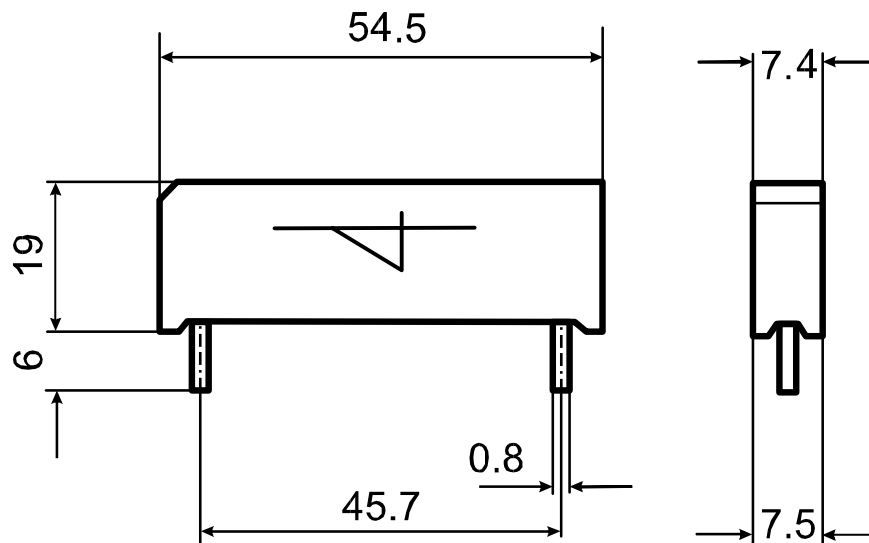

| Ordering | Part Name | Marking on Product | Delivering Mode | Base Qty | Ordering Code |
|----------|---------------|--------------------|-----------------|----------|---------------|
| Standard | IXBOD 1 -12R | IXBOD 1 -12R | Box | 20 | 468649 |
| Standard | IXBOD 1 -12RD | IXBOD 1 -12RD | Box | 20 | 472948 |
| Standard | IXBOD 1 -13R | IXBOD 1 -13R | Box | 20 | 468657 |
| Standard | IXBOD 1 -13RD | IXBOD 1 -13RD | Box | 20 | 472956 |
| Standard | IXBOD 1 -14R | IXBOD 1 -14R | Box | 20 | 468665 |
| Standard | IXBOD 1 -14RD | IXBOD 1 -14RD | Box | 20 | 472964 |
| Standard | IXBOD 1 -15R | IXBOD 1 -15R | Box | 20 | 468673 |
| Standard | IXBOD 1 -15RD | IXBOD 1 -15RD | Box | 20 | 472972 |
| Standard | IXBOD 1 -16R | IXBOD 1 -16R | Box | 20 | 468681 |
| Standard | IXBOD 1 -16RD | IXBOD 1 -16RD | Box | 20 | 472794 |
| Standard | IXBOD 1 -17R | IXBOD 1 -17R | Box | 20 | 468703 |
| Standard | IXBOD 1 -17RD | IXBOD 1 -17RD | Box | 20 | 472980 |
| Standard | IXBOD 1 -18R | IXBOD 1 -18R | Box | 20 | 468711 |
| Standard | IXBOD 1 -18RD | IXBOD 1 -18RD | Box | 20 | 472999 |
| Standard | IXBOD 1 -19R | IXBOD 1 -19R | Box | 20 | 468738 |
| Standard | IXBOD 1 -19RD | IXBOD 1 -19RD | Box | 20 | 473006 |
| Standard | IXBOD 1 -20R | IXBOD 1 -20R | Box | 20 | 468746 |
| Standard | IXBOD 1 -20RD | IXBOD 1 -20RD | Box | 20 | 473014 |
| Standard | IXBOD 1 -21R | IXBOD 1 -21R | Box | 20 | 468754 |
| Standard | IXBOD 1 -21RD | IXBOD 1 -21RD | Box | 20 | 473022 |
| Standard | IXBOD 1 -22R | IXBOD 1 -22R | Box | 20 | 468762 |
| Standard | IXBOD 1 -22RD | IXBOD 1 -22RD | Box | 20 | 473030 |
| Standard | IXBOD 1 -23R | IXBOD 1 -23R | Box | 20 | 468770 |
| Standard | IXBOD 1 -23RD | IXBOD 1 -23RD | Box | 20 | 472786 |
| Standard | IXBOD 1 -24R | IXBOD 1 -24R | Box | 20 | 468789 |
| Standard | IXBOD 1 -24RD | IXBOD 1 -24RD | Box | 20 | 473049 |
| Standard | IXBOD 1 -25R | IXBOD 1 -25R | Box | 20 | 468797 |
| Standard | IXBOD 1 -25RD | IXBOD 1 -25RD | Box | 20 | 473057 |
| Standard | IXBOD 1 -26R | IXBOD 1 -26R | Box | 20 | 468800 |
| Standard | IXBOD 1 -26RD | IXBOD 1 -26RD | Box | 20 | 473065 |
| Standard | IXBOD 1 -28R | IXBOD 1 -28R | Box | 20 | 468819 |
| Standard | IXBOD 1 -28RD | IXBOD 1 -28RD | Box | 20 | 473073 |
| Standard | IXBOD 1 -30R | IXBOD 1 -30R | Box | 20 | 468827 |
| Standard | IXBOD 1 -30RD | IXBOD 1 -30RD | Box | 20 | 473081 |
| Standard | IXBOD 1 -32R | IXBOD 1 -32R | Box | 20 | 468835 |
| Standard | IXBOD 1 -32RD | IXBOD 1 -32RD | Box | 20 | 473103 |
| Standard | IXBOD 1 -34R | IXBOD 1 -34R | Box | 20 | 468843 |
| Standard | IXBOD 1 -36R | IXBOD 1 -36R | Box | 20 | 468851 |
| Standard | IXBOD 1 -38R | IXBOD 1 -38R | Box | 20 | 468878 |
| Standard | IXBOD 1 -40R | IXBOD 1 -40R | Box | 20 | 468886 |
| Standard | IXBOD 1 -42R | IXBOD 1 -42R | Box | 20 | 468894 |

Curves

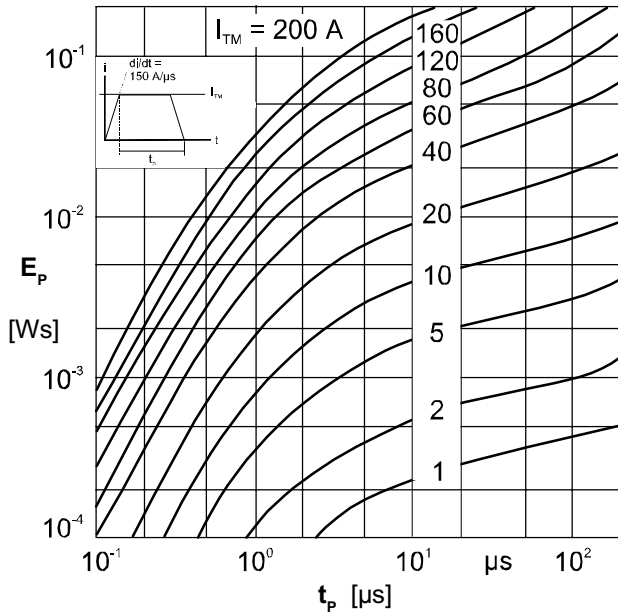

Fig. 1 Energy per pulse for single BOD element for trapezoidal wave current. E_p must be multiplied by number of elements for total energy

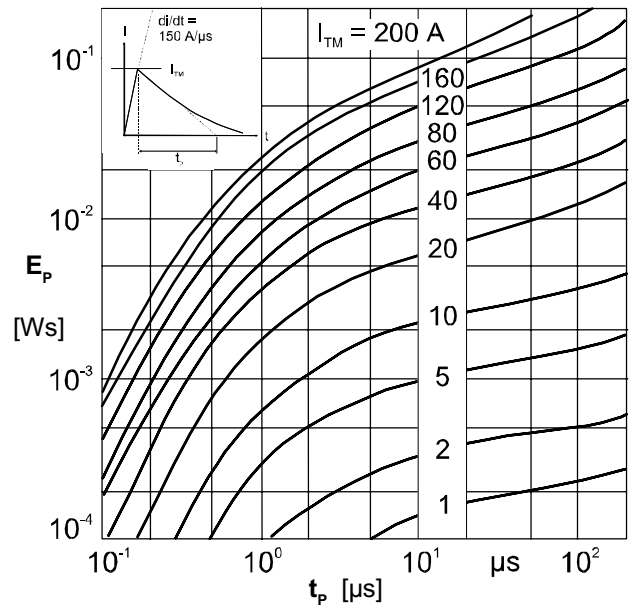

Fig. 2 Energy per pulse for single BOD element for exponentially decaying current pulse. E_p must be multiplied by number of elements for total energy

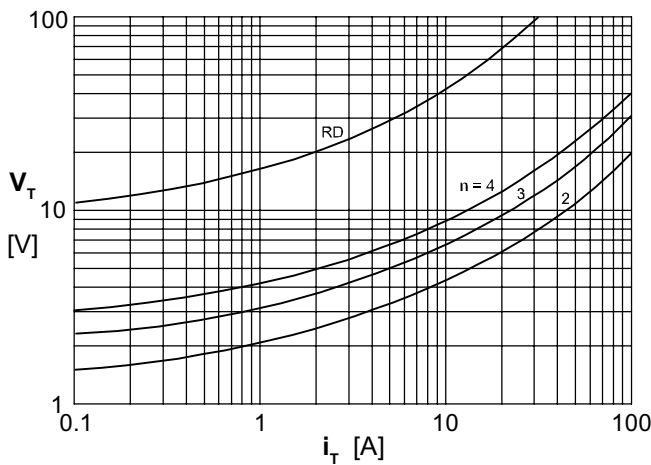

Fig. 3 On-state voltage at $T_{vj} = 125^\circ\text{C}$

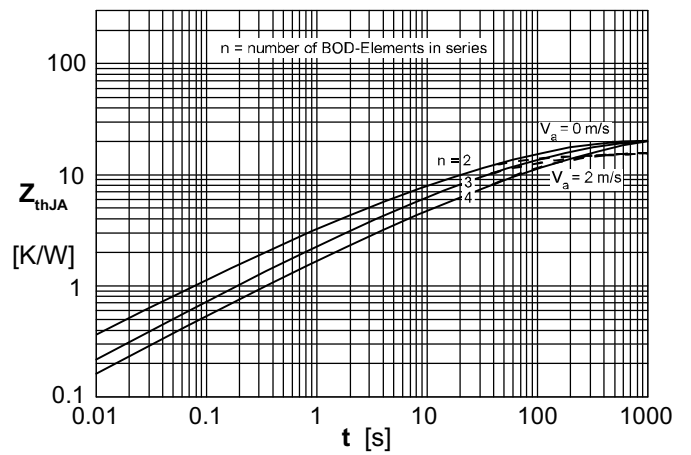

Fig. 4 Transient thermal resistance