



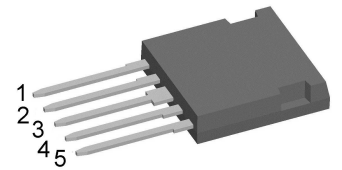
Standard Rectifier

3~ Rectifier
$V_{RRM} = 1600\text{ V}$
$I_{DAV} = 30\text{ A}$
$I_{FSM} = 150\text{ A}$

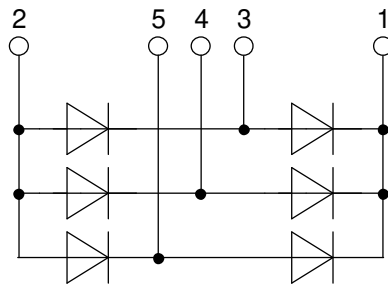
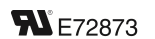
3~ Rectifier Bridge

Part number

FUO22-16N



Backside: isolated



Features / Advantages:

- Package with DCB ceramic
- Improved temperature and power cycling
- Planar passivated chips
- Very low forward voltage drop
- Very low leakage current

Applications:

- Diode for main rectification
- For single and three phase bridge configurations

Package: i4-Pac

- Isolation Voltage: 3000 V~
- Industry convenient outline
- RoHS compliant
- Epoxy meets UL 94V-0
- Soldering pins for PCB mounting
- Backside: DCB ceramic
- Reduced weight
- Advanced power cycling

Disclaimer Notice

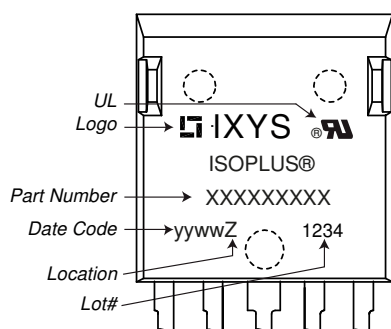
Information furnished is believed to be accurate and reliable. However, users should independently evaluate the suitability of and test each product selected for their own applications. Littelfuse products are not designed for, and may not be used in, all applications. Read complete Disclaimer Notice at www.littelfuse.com/disclaimer-electronics.

Rectifier				Ratings			
Symbol	Definition	Conditions		min.	typ.	max.	Unit
V_{RSM}	max. non-repetitive reverse blocking voltage					1700	V
V_{RRM}	max. repetitive reverse blocking voltage					1600	V
I_R	reverse current	$V_R = 1600$ V		$T_{VJ} = 25^\circ\text{C}$		10	μA
		$V_R = 1600$ V		$T_{VJ} = 150^\circ\text{C}$		1	mA
V_F	forward voltage drop	$I_F = 10$ A		$T_{VJ} = 25^\circ\text{C}$		1.20	V
		$I_F = 30$ A				1.62	V
		$I_F = 10$ A		$T_{VJ} = 150^\circ\text{C}$		1.12	V
		$I_F = 30$ A				1.73	V
I_{DAV}	bridge output current	$T_C = 120^\circ\text{C}$	rectangular	$T_{VJ} = 175^\circ\text{C}$		30	A
			$d = \frac{1}{3}$				
V_{FO}	threshold voltage	} for power loss calculation only		$T_{VJ} = 175^\circ\text{C}$		0.81	V
r_F	slope resistance					31	m Ω
R_{thJC}	thermal resistance junction to case					3	K/W
R_{thCH}	thermal resistance case to heatsink				0.2		K/W
P_{tot}	total power dissipation			$T_C = 25^\circ\text{C}$		50	W
I_{FSM}	max. forward surge current	$t = 10$ ms; (50 Hz), sine		$T_{VJ} = 45^\circ\text{C}$		150	A
		$t = 8,3$ ms; (60 Hz), sine		$V_R = 0$ V		160	A
		$t = 10$ ms; (50 Hz), sine		$T_{VJ} = 150^\circ\text{C}$		130	A
		$t = 8,3$ ms; (60 Hz), sine		$V_R = 0$ V		140	A
I^2t	value for fusing	$t = 10$ ms; (50 Hz), sine		$T_{VJ} = 45^\circ\text{C}$		115	A ² s
		$t = 8,3$ ms; (60 Hz), sine		$V_R = 0$ V		105	A ² s
		$t = 10$ ms; (50 Hz), sine		$T_{VJ} = 150^\circ\text{C}$		85	A ² s
		$t = 8,3$ ms; (60 Hz), sine		$V_R = 0$ V		82	A ² s
C_J	junction capacitance	$V_R = 400$ V; $f = 1$ MHz		$T_{VJ} = 25^\circ\text{C}$		4	pF



Package i4-Pac		Ratings				
Symbol	Definition	Conditions	min.	typ.	max.	Unit
I_{RMS}	RMS current	per terminal			35	A
T_{VJ}	virtual junction temperature		-55		175	°C
T_{op}	operation temperature		-55		150	°C
T_{stg}	storage temperature		-55		150	°C
Weight				6		g
F_C	mounting force with clip		20		120	N
$d_{Spp/ App}$	creepage distance on surface / striking distance through air	terminal to terminal	1.7			mm
$d_{Spb/ Apb}$		terminal to backside	5.1			mm
V_{ISOL}	isolation voltage	t = 1 second	3000			V
		t = 1 minute	2500			V

Product Marking

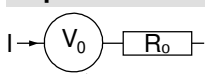


Ordering	Ordering Number	Marking on Product	Delivery Mode	Quantity	Code No.
Standard	FUO22-16N	FUO22-16N	Tube	25	500357

Equivalent Circuits for Simulation

* on die level

$T_{VJ} = 175^{\circ}C$

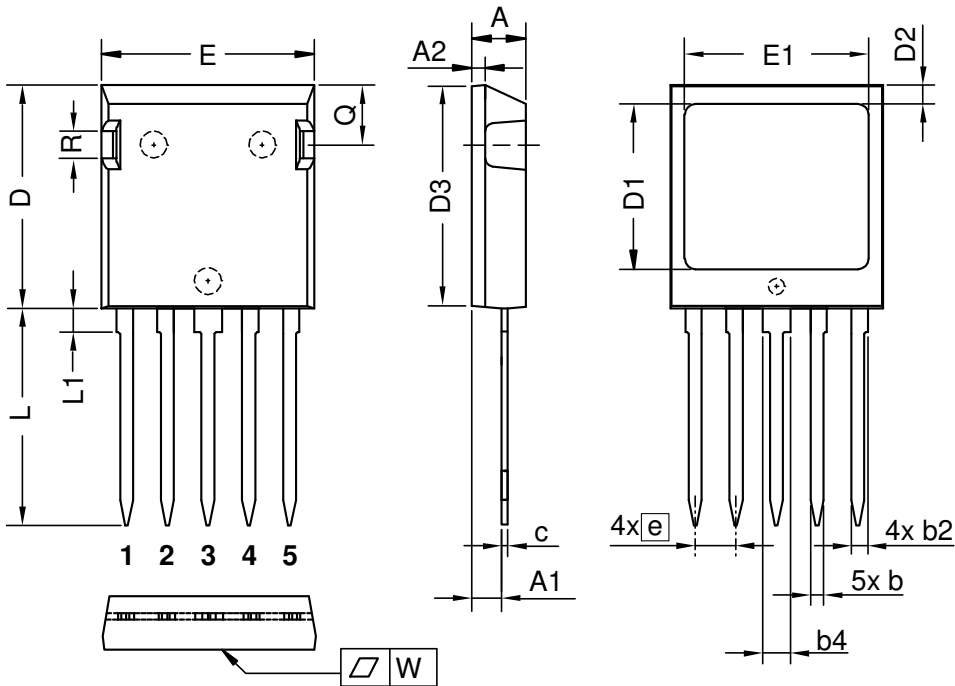


Rectifier

$V_{0\ max}$	threshold voltage	0.81	V
$R_{0\ max}$	slope resistance *	28	mΩ

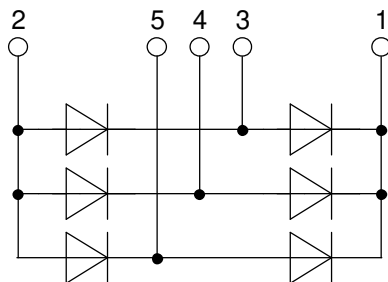


Outlines i4-Pac



Dim.	Millimeter		Inches	
	min	max	min	max
A	4.83	5.21	0.190	0.205
A1	2.59	3.00	0.102	0.118
A2	1.17	2.16	0.046	0.085
b	1.14	1.40	0.045	0.055
b2	1.47	1.73	0.058	0.068
b4	2.54	2.79	0.100	0.110
c	0.51	0.74	0.020	0.029
D	20.80	21.34	0.819	0.840
D1	14.99	15.75	0.590	0.620
D2	1.65	2.03	0.065	0.080
D3	20.30	20.70	0.799	0.815
E	19.56	20.29	0.770	0.799
E1	16.76	17.53	0.660	0.690
e	3.81 BSC		0.150 BSC	
L	19.81	21.34	0.780	0.840
L1	2.11	2.59	0.083	0.102
Q	5.33	6.20	0.210	0.244
R	2.54	4.57	0.100	0.180
W	-	0.10	-	0.004

Die konvexe Form des Substrates ist typ. < 0.05 mm über der Kunststoffoberfläche der Bauteilunterseite
The convexbow of substrate is typ. < 0.05 mm over plastic surface level of device bottom side



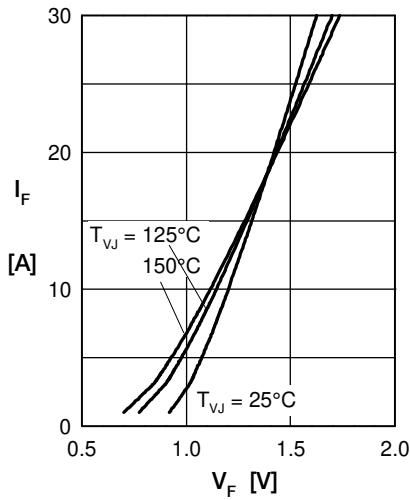
Rectifier


Fig. 1 Forward current versus voltage drop per diode

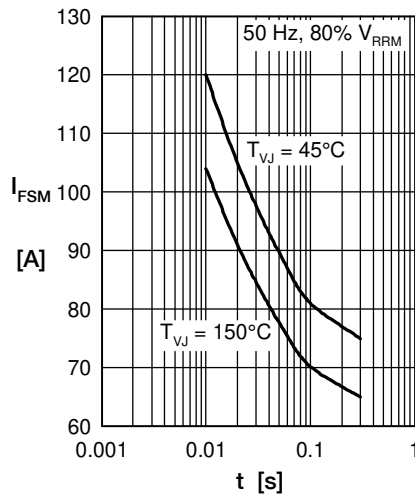


Fig. 2 Surge overload current

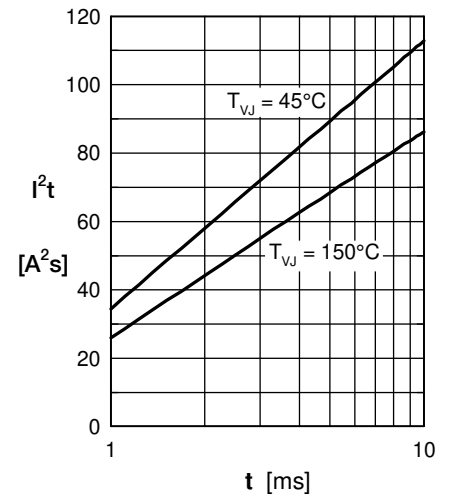
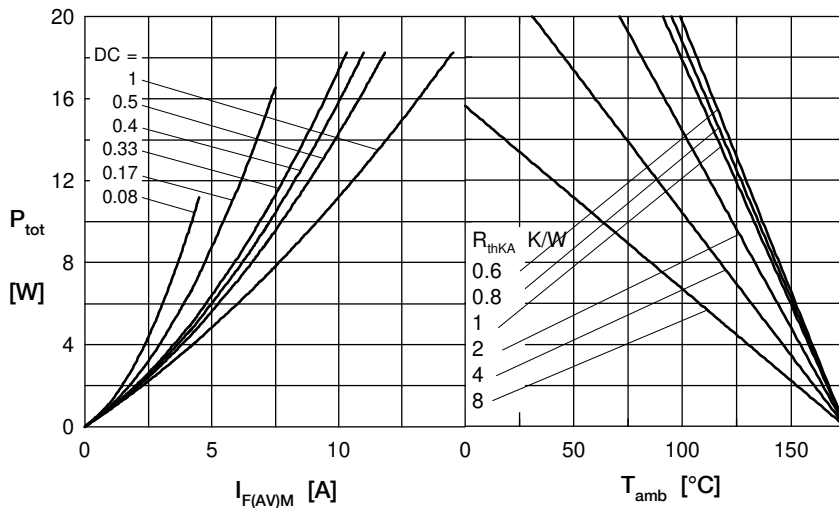

 Fig. 3 I^2t versus time per diode


Fig. 4 Power dissipation vs. direct output current & ambient temperature

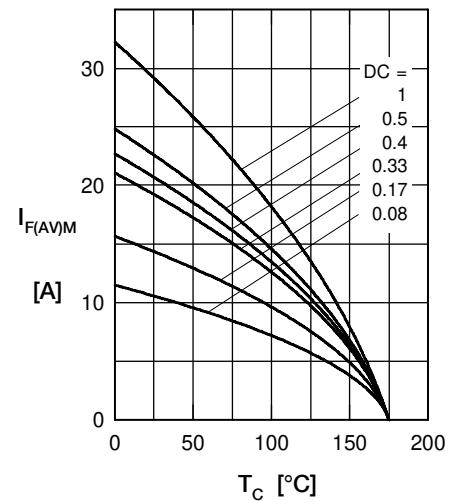


Fig. 5 Max. forward current vs. case temperature

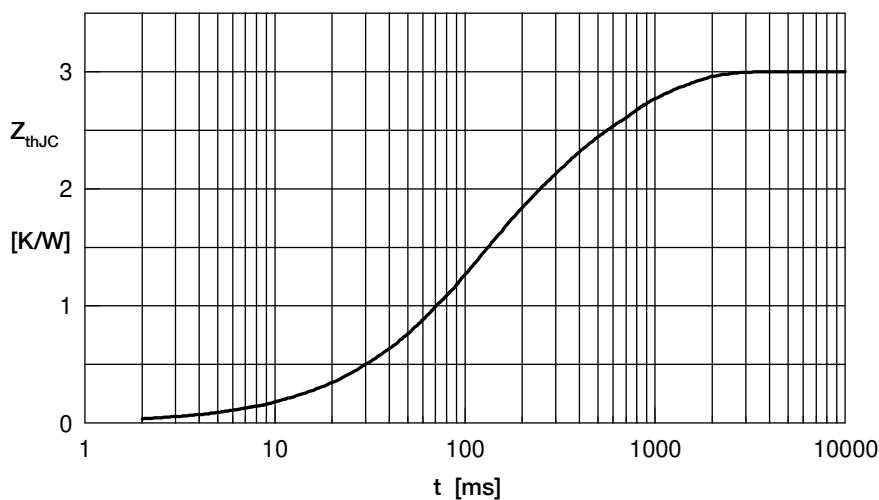


Fig. 6 Transient thermal impedance junction to case

 Constants for Z_{thJC} calculation:

i	R_{thi} (K/W)	t_i (s)
1	1.359	0.1015
2	0.3286	0.1026
3	0.4651	0.4919
4	0.8473	0.62