

# Standard Rectifier

$$V_{RRM} = 2 \times 800 \text{ V}$$

$$I_{FAV} = 8 \text{ A}$$

$$V_F = 1.08 \text{ V}$$

Phase leg

Part number

**DSP8-08AS**

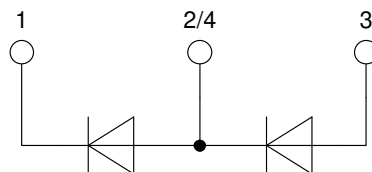
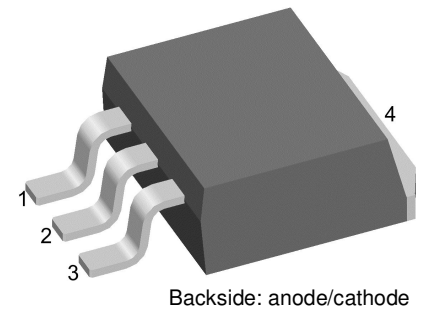

### Features / Advantages:

- Planar passivated chips
- Very low leakage current
- Very low forward voltage drop
- Improved thermal behaviour

### Applications:

- Diode for main rectification
- For single and three phase bridge configurations

### Package: TO-263 (D2Pak)

- Industry standard outline
- RoHS compliant
- Epoxy meets UL 94V-0

### Disclaimer Notice

Information furnished is believed to be accurate and reliable. However, users should independently evaluate the suitability of and test each product selected for their own applications. Littelfuse products are not designed for, and may not be used in, all applications. Read complete Disclaimer Notice at [www.littelfuse.com/disclaimer-electronics](http://www.littelfuse.com/disclaimer-electronics).

| Rectifier  |  |   |           | Ratings                      |      |      |                      |
|------------|--|---|-----------|------------------------------|------|------|----------------------|
| Symbol     | Definition                                   | Conditions  |           | min.                         | typ. | max. | Unit                 |
| $V_{RSM}$  | max. non-repetitive reverse blocking voltage |   |           |                              |      | 900  | V                    |
| $V_{RRM}$  | max. repetitive reverse blocking voltage     |   |           |                              |      | 800  | V                    |
| $I_R$      | reverse current                              | $V_R = 800\text{ V}$                              |           | $T_{VJ} = 25^\circ\text{C}$  |      | 10   | $\mu\text{A}$        |
|            |  | $V_R = 800\text{ V}$                              |           | $T_{VJ} = 150^\circ\text{C}$ |      | 0.2  | mA                   |
| $V_F$      | forward voltage drop                         | $I_F = 8\text{ A}$                                |           | $T_{VJ} = 25^\circ\text{C}$  |      | 1.16 | V                    |
|            |  | $I_F = 16\text{ A}$                               |           |                              |      | 1.35 | V                    |
|            |  | $I_F = 8\text{ A}$                                |           | $T_{VJ} = 150^\circ\text{C}$ |      | 1.08 | V                    |
|            |  | $I_F = 16\text{ A}$                               |           |                              |      | 1.34 | V                    |
| $I_{FAV}$  | average forward current                      | $T_C = 160^\circ\text{C}$                         |           | $T_{VJ} = 175^\circ\text{C}$ |      | 8    | A                    |
|            |  | rectangular                                       | $d = 0.5$ |                              |      |      |                      |
| $V_{FO}$   | threshold voltage                            |   |           | $T_{VJ} = 175^\circ\text{C}$ |      | 0.79 | V                    |
| $r_F$      | slope resistance                             |   |           |                              |      | 33   | $\text{m}\Omega$     |
|            |  | } for power loss calculation only                 |           |                              |      |      |                      |
| $R_{thJC}$ | thermal resistance junction to case          |   |           |                              |      | 1.5  | K/W                  |
| $R_{thCH}$ | thermal resistance case to heatsink          |   |           |                              | 0.25 |      | K/W                  |
| $P_{tot}$  | total power dissipation                      |   |           | $T_C = 25^\circ\text{C}$     |      | 100  | W                    |
| $I_{FSM}$  | max. forward surge current                   | $t = 10\text{ ms}; (50\text{ Hz}), \text{ sine}$  |           | $T_{VJ} = 45^\circ\text{C}$  |      | 120  | A                    |
|            |  | $t = 8,3\text{ ms}; (60\text{ Hz}), \text{ sine}$ |           | $V_R = 0\text{ V}$           |      | 130  | A                    |
|            |  | $t = 10\text{ ms}; (50\text{ Hz}), \text{ sine}$  |           | $T_{VJ} = 150^\circ\text{C}$ |      | 100  | A                    |
|            |  | $t = 8,3\text{ ms}; (60\text{ Hz}), \text{ sine}$ |           | $V_R = 0\text{ V}$           |      | 110  | A                    |
| $I^2t$     | value for fusing                             | $t = 10\text{ ms}; (50\text{ Hz}), \text{ sine}$  |           | $T_{VJ} = 45^\circ\text{C}$  |      | 72   | $\text{A}^2\text{s}$ |
|            |  | $t = 8,3\text{ ms}; (60\text{ Hz}), \text{ sine}$ |           | $V_R = 0\text{ V}$           |      | 70   | $\text{A}^2\text{s}$ |
|            |  | $t = 10\text{ ms}; (50\text{ Hz}), \text{ sine}$  |           | $T_{VJ} = 150^\circ\text{C}$ |      | 50   | $\text{A}^2\text{s}$ |
|            |  | $t = 8,3\text{ ms}; (60\text{ Hz}), \text{ sine}$ |           | $V_R = 0\text{ V}$           |      | 50   | $\text{A}^2\text{s}$ |
| $C_J$      | junction capacitance                         | $V_R = 400\text{ V}; f = 1\text{ MHz}$            |           | $T_{VJ} = 25^\circ\text{C}$  |      | 4    | pF                   |



| Package TO-263 (D2Pak) |                              |              | Ratings |      |      |      |
|------------------------|------------------------------|--------------|---------|------|------|------|
| Symbol                 | Definition                   | Conditions   | min.    | typ. | max. | Unit |
| $I_{RMS}$              | RMS current                  | per terminal |         |      | 25   | A    |
| $T_{VJ}$               | virtual junction temperature |              | -55     |      | 175  | °C   |
| $T_{op}$               | operation temperature        |              | -55     |      | 150  | °C   |
| $T_{stg}$              | storage temperature          |              | -55     |      | 150  | °C   |
| <b>Weight</b>          |                              |              |         | 1.5  |      | g    |
| $F_C$                  | mounting force with clip     |              | 20      |      | 60   | N    |

**Product Marking**

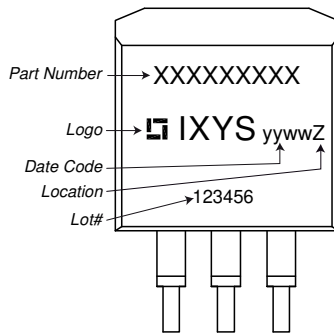

| Ordering    | Ordering Number | Marking on Product | Delivery Mode | Quantity | Code No. |
|-------------|-----------------|--------------------|---------------|----------|----------|
| Standard    | DSP8-08AS-TRL   | DSP8-08AS-TRL      | Tape & Reel   | 800      | 504315   |
| Alternative | DSP8-08AS-TUB   | DSP8-08AS          | Tube          | 50       | 465445   |

| Similar Part | Package              | Voltage class |
|--------------|----------------------|---------------|
| DSP8-08S     | TO-263AB (D2Pak) (2) | 800           |
| DSP8-08A     | TO-220AB (3)         | 800           |
| DSP8-12AS    | TO-263AA (D2Pak) (3) | 1200          |
| DSP8-12S     | TO-263AB (D2Pak) (2) | 1200          |

|           |                  |      |
|-----------|------------------|------|
| DSP8-12A  | TO-220AB (3)     | 1200 |
| DSP8-12AC | ISOPLUS220AB (3) | 1200 |

**Equivalent Circuits for Simulation**

\* on die level

$T_{VJ} = 175^{\circ}\text{C}$

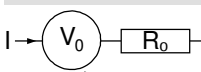

**Rectifier**

|              |                    |      |    |
|--------------|--------------------|------|----|
| $V_{0\ max}$ | threshold voltage  | 0.79 | V  |
| $R_{0\ max}$ | slope resistance * | 30   | mΩ |



**Outlines TO-263 (D2Pak)**

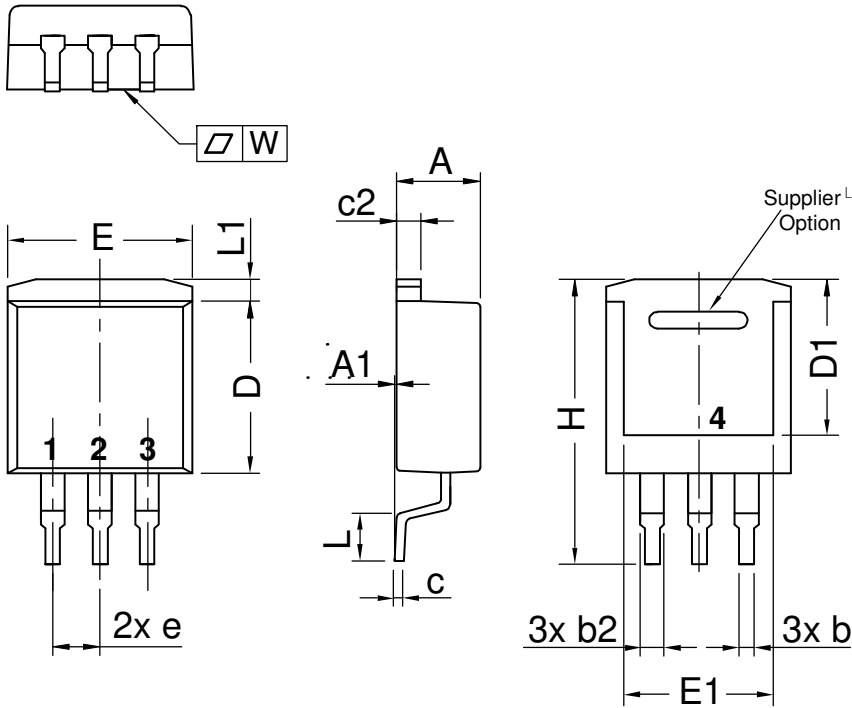

| Dim. | Millimeter |       | Inches      |       |
|------|------------|-------|-------------|-------|
|      | min        | max   | min         | max   |
| A    | 4.06       | 4.83  | 0.160       | 0.190 |
| A1   | typ. 0.10  |       | typ. 0.004  |       |
| A2   | 2.41       |       | 0.095       |       |
| b    | 0.51       | 0.99  | 0.020       | 0.039 |
| b2   | 1.14       | 1.40  | 0.045       | 0.055 |
| c    | 0.40       | 0.74  | 0.016       | 0.029 |
| c2   | 1.14       | 1.40  | 0.045       | 0.055 |
| D    | 8.38       | 9.40  | 0.330       | 0.370 |
| D1   | 8.00       | 8.89  | 0.315       | 0.350 |
| D2   | 2.5        |       | 0.098       |       |
| E    | 9.65       | 10.41 | 0.380       | 0.410 |
| E1   | 6.22       | 8.50  | 0.245       | 0.335 |
| e    | 2,54 BSC   |       | 0,100 BSC   |       |
| e1   | 4.28       |       | 0.169       |       |
| H    | 14.61      | 15.88 | 0.575       | 0.625 |
| L    | 1.78       | 2.79  | 0.070       | 0.110 |
| L1   | 1.02       | 1.68  | 0.040       | 0.066 |
| W    | typ. 0.02  | 0.040 | typ. 0.0008 | 0.002 |

*All dimensions conform with and/or within JEDEC standard.*

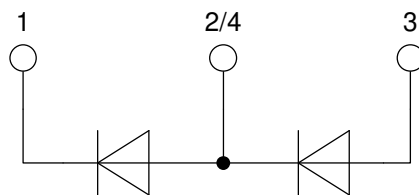



**Rectifier**

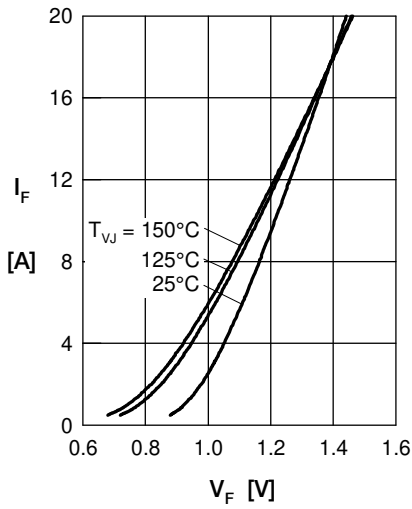

Fig. 1 Forward current versus voltage drop per diode

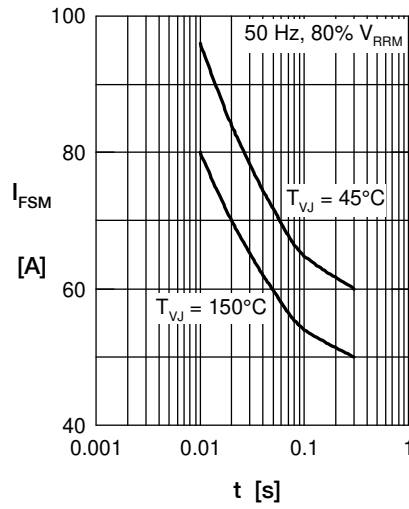

Fig. 2 Surge overload current

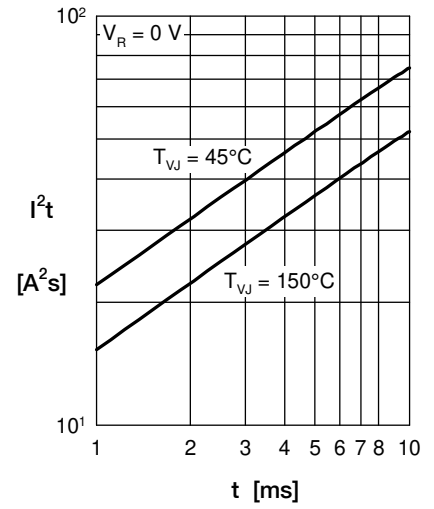

Fig. 3  $I^2t$  versus time per diode

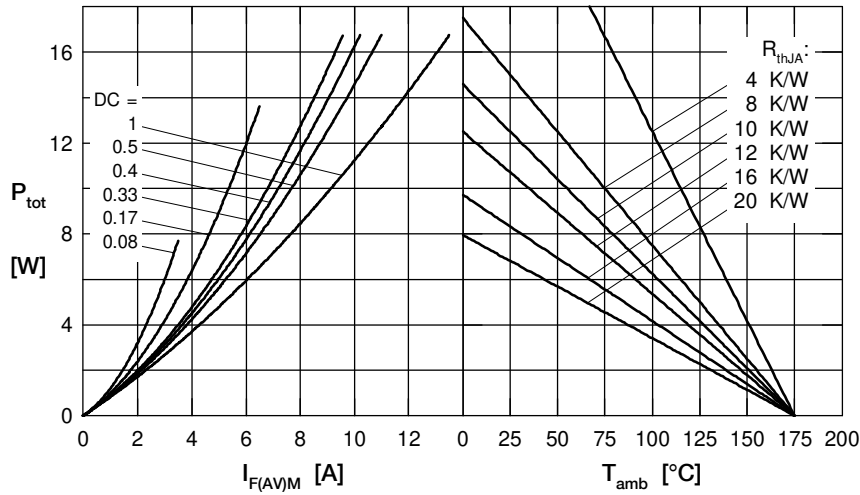

Fig. 4 Power dissipation vs. direct output current and ambient temperature

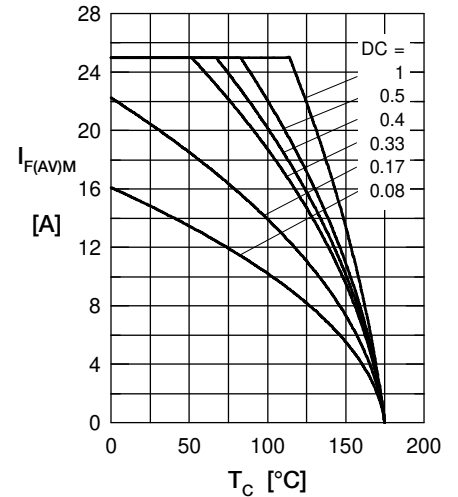

Fig. 5 Max. forward current vs. case temperature

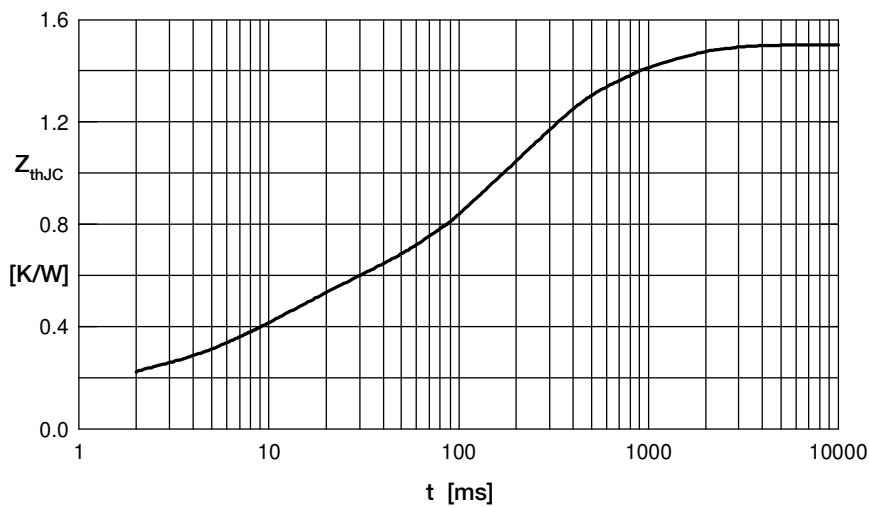

Fig. 6 Transient thermal impedance junction to case

Constants for  $Z_{thJC}$  calculation:

| i | $R_{thi}$ (K/W) | $t_i$ (s) |
|---|-----------------|-----------|
| 1 | 0.155           | 0.0005    |
| 2 | 0.332           | 0.0095    |
| 3 | 0.713           | 0.17      |
| 4 | 0.3             | 0.8       |
| 5 | 0.00001         | 0.00001   |